



This is a digital copy of a book that was preserved for generations on library shelves before it was carefully scanned by Google as part of a project to make the world's books discoverable online.

It has survived long enough for the copyright to expire and the book to enter the public domain. A public domain book is one that was never subject to copyright or whose legal copyright term has expired. Whether a book is in the public domain may vary country to country. Public domain books are our gateways to the past, representing a wealth of history, culture and knowledge that's often difficult to discover.

Marks, notations and other marginalia present in the original volume will appear in this file - a reminder of this book's long journey from the publisher to a library and finally to you.

Usage guidelines

Google is proud to partner with libraries to digitize public domain materials and make them widely accessible. Public domain books belong to the public and we are merely their custodians. Nevertheless, this work is expensive, so in order to keep providing this resource, we have taken steps to prevent abuse by commercial parties, including placing technical restrictions on automated querying.

We also ask that you:

- + *Make non-commercial use of the files* We designed Google Book Search for use by individuals, and we request that you use these files for personal, non-commercial purposes.
- + *Refrain from automated querying* Do not send automated queries of any sort to Google's system: If you are conducting research on machine translation, optical character recognition or other areas where access to a large amount of text is helpful, please contact us. We encourage the use of public domain materials for these purposes and may be able to help.
- + *Maintain attribution* The Google "watermark" you see on each file is essential for informing people about this project and helping them find additional materials through Google Book Search. Please do not remove it.
- + *Keep it legal* Whatever your use, remember that you are responsible for ensuring that what you are doing is legal. Do not assume that just because we believe a book is in the public domain for users in the United States, that the work is also in the public domain for users in other countries. Whether a book is still in copyright varies from country to country, and we can't offer guidance on whether any specific use of any specific book is allowed. Please do not assume that a book's appearance in Google Book Search means it can be used in any manner anywhere in the world. Copyright infringement liability can be quite severe.

About Google Book Search

Google's mission is to organize the world's information and to make it universally accessible and useful. Google Book Search helps readers discover the world's books while helping authors and publishers reach new audiences. You can search through the full text of this book on the web at <http://books.google.com/>

GIFT OF

U.S. Supt. of Documents



EX LIBRIS



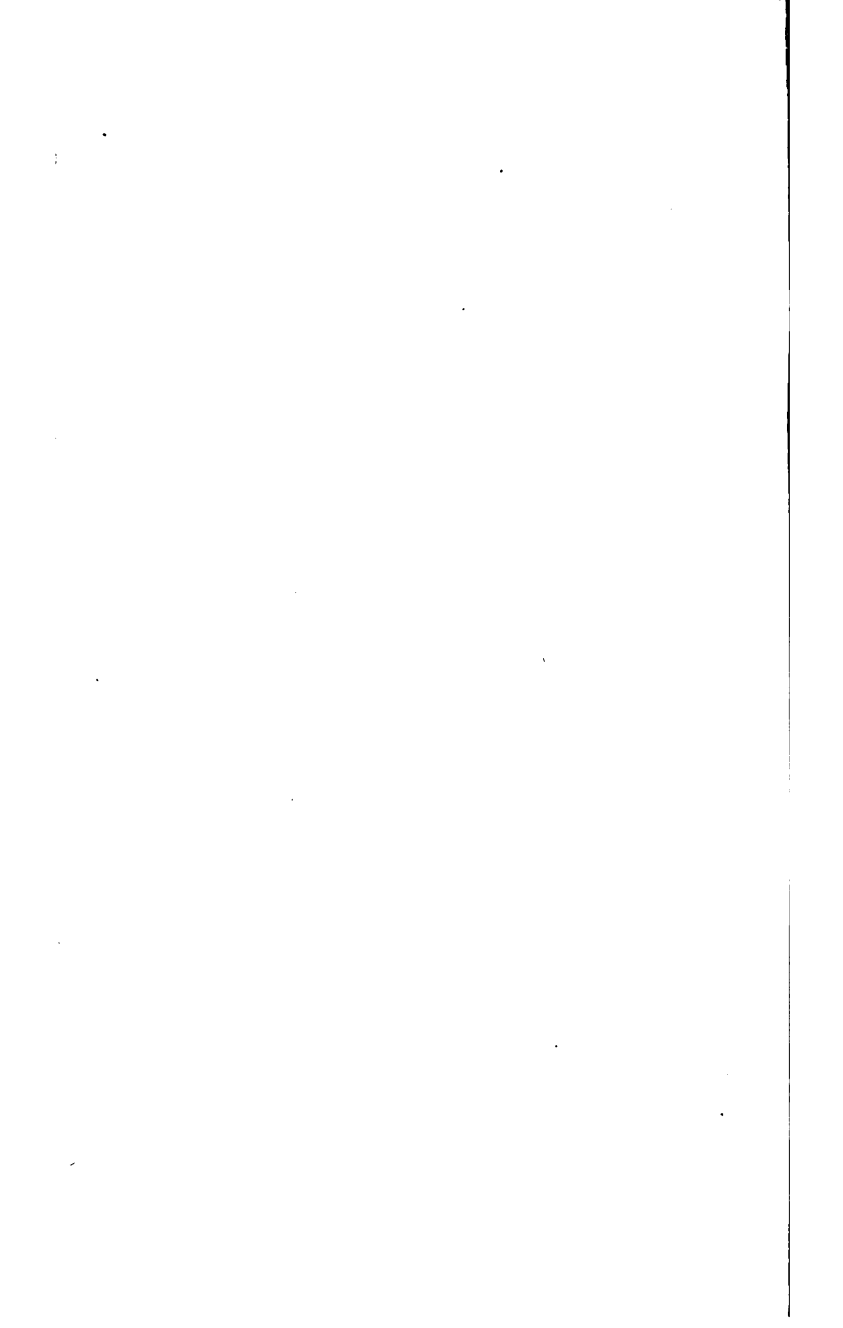

UNIV. OF
CALIFORNIA

at

No. 1000

PLATE I

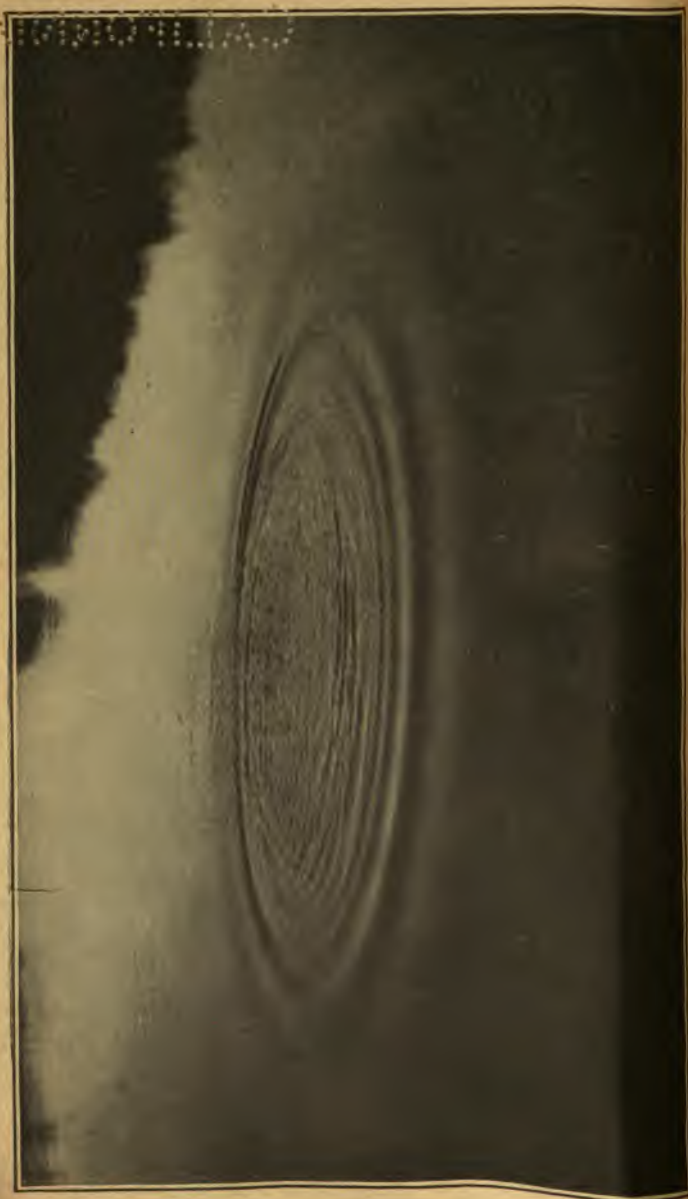

4.5 ...

The Principles Underlying Radio Communication

(SECOND EDITION)



Radio Communication Pamphlet No. 40

Prepared by the Bureau of Standards

Revised to May 24, 1921

Signal Corps, U. S. Army



TO VIND
ABSOGLIAO

T 15741
11-
31-

U. S. S. Documents.

WAR DEPARTMENT.

Document No. 1069.

Office of The Adjutant General.

WAR DEPARTMENT,
Washington, June 10, 1921.

The following publication entitled "The Principles Underlying Radio Communication," is published for the information and guidance of all concerned.

[062.11, A. G. O.]

By order of the Secretary of War:

PEYTON C. MARCH,
Major General, Chief of Staff.

Official:

P. C. HARRIS,
The Adjutant General.

ADDITIONAL COPIES
OF THIS PUBLICATION MAY BE PROCURED FROM
THE SUPERINTENDENT OF DOCUMENTS
GOVERNMENT PRINTING OFFICE
WASHINGTON, D. C.
AT
\$1.00 PER COPY (BUCKRAM)

PREFACE TO FIRST EDITION.

The Principles Underlying Radio Communication.

Prepared by the Bureau of Standards under the direction of the Training Section of the Office of the Chief Signal Officer of the Army.

Acknowledgment is made of the valuable service rendered the Signal Corps by the Bureau of Standards through the work of Dr. J. H. Dellinger, physicist, Bureau of Standards, and the following men engaged with him in the writing of this book:

F. W. Grover,

Consulting Physicist, Bureau of Standards; Assistant Professor of Electrical Engineering, Union University.

C. M. Smith,

Associate Professor of Physics, Purdue University.

G. F. Wittig,

Assistant Professor of Electrical Engineering, Yale University.

A. D. Cole,

Professor of Physics, Ohio State University.

L. P. Wheeler,

Assistant Professor of Physics, Yale University.

H. M. Royal,

Professor of Mathematics, Clarkson College of Technology.

In this book are presented briefly the basic facts and principles of electromagnetism and their application to radio communication. In the effort to present these topics in a simple manner for students with very little mathematical preparation, it has been necessary at times to use definitions, illustrations, and analogies which would not be used in a work prepared for more advanced students. Frequent references to standard books are given for further study, and students should be encouraged, as far as possible, to consult them.

December 10, 1918.

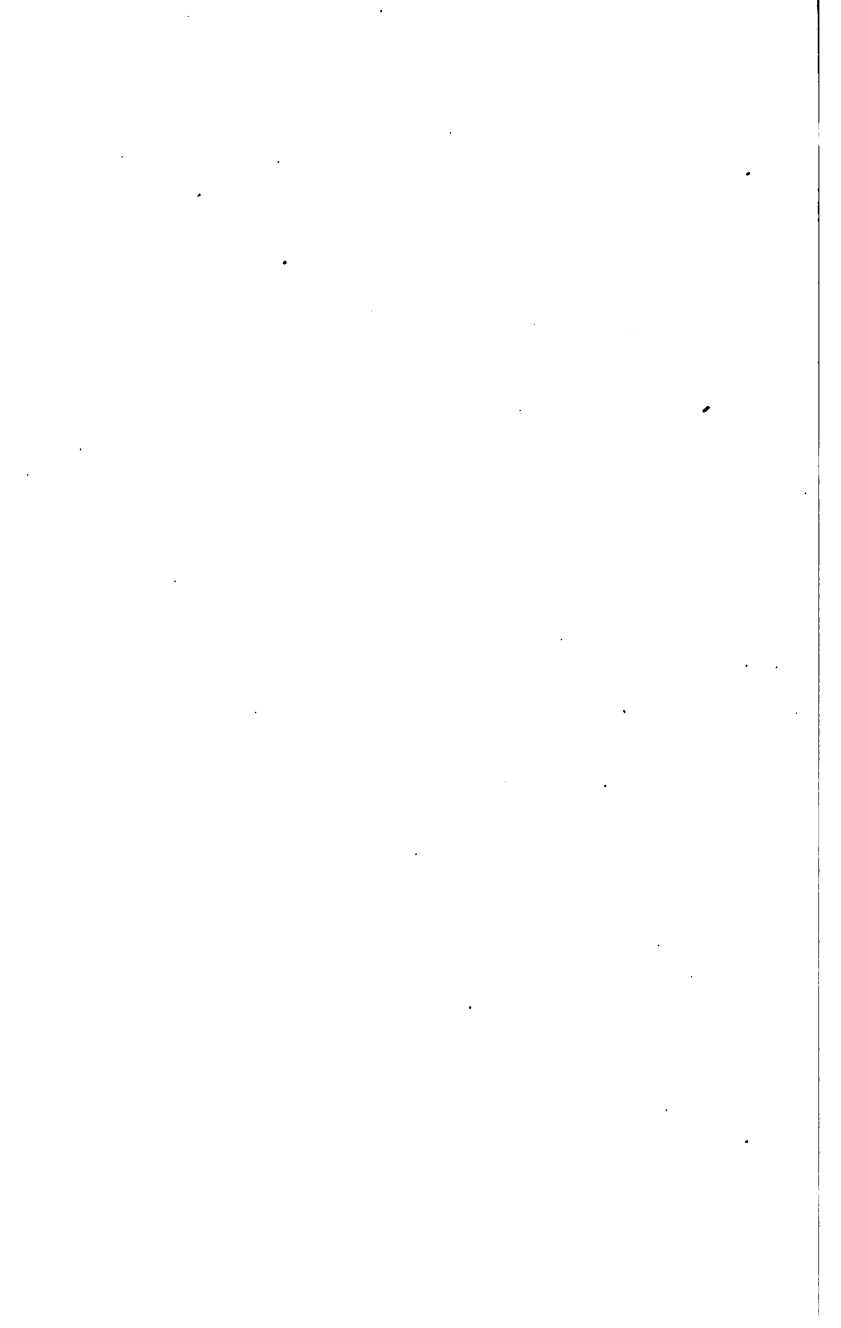

PREFACE TO SECOND EDITION.

The first edition of this book was prepared in the summer of 1918 by the Bureau of Standards at the request and under the direction of the Training Section of the Office of the Chief Signal Officer of the Army for use as a textbook for the training of enlisted personnel of the Signal Corps for radio work. The book was prepared by the members of the staff of the Bureau of Standards mentioned in the preface to the first edition, some of whom were members of the faculties of certain universities, and were temporarily added to the staff of the Bureau for this purpose.

The book has been found useful not only for the purpose for which it was originally prepared—the training of Signal Corps personnel—but also as an elementary textbook of radio and general electricity for use in schools and colleges and elsewhere.

A number of errors appearing in the first edition have been corrected, and some parts have been revised. The section on batteries has been rewritten. The material on apparatus for undamped wave transmission and electron tubes has been replaced by new material. A brief discussion of ordinary wire telephony has been added. The section on transformers has been considerably amplified. Some new illustrations have been added, replacing illustrations of apparatus now obsolete. New numbers have been assigned to all sections beyond Section 172, and new numbers have been assigned to all figures beyond Fig. 214. The first edition contained 355 pages, while the present edition contains 619 pages.

Acknowledgment should be made of the assistance rendered by the many interested persons who have called attention to errors appearing in the first edition. It is not possible to mention the names of all who have offered suggestions. Particular mention should be made of a very careful examination of the whole book made by Dr. H. S. Uhler, of Yale University.

The work of revision and the preparation of a considerable part of the new material has been done by Mr. R. S. Ould. The revision has been under the general supervision of Dr. J. H. Dellinger. A number of other members of the staff of the Bureau

of Standards have assisted in the work of revision by suggestions, and by preparing new material. The section on batteries has been rewritten by Mr. G. W. Vinal. Much of the revision of the chapter on electron tubes has been done by Mr. E. S. Purington and Mr. L. M. Hull. The authors who prepared the first edition have offered valuable suggestions for desirable changes. Mention is made of the work of Professor C. M. Smith on the index.

Acknowledgment is made to the General Electric Co. for photographs of the Alexanderson alternator, to the Federal Telegraph Co. for photographs of the arc converter, to the Western Electric Co. for detailed drawings of a telephone transmitter and receiver, and to the Electric Storage Battery Co. for a photograph of a lead storage cell.

TABLE OF CONTENTS.

INTRODUCTION.

	Page.
1. What radio communication means.....	19
2. Fundamental ideas of the electric circuit.....	21

Chapter 1. Elementary Electricity.

A. ELECTRIC CURRENT.

3. Effects of electric current.....	29
4. Direction of current.....	30
5. Measurement of electric current and quantity of electricity.....	32
6. Electrons.....	33

B. RESISTANCE AND RESISTIVITY.

7. Resistance and conductance.....	34
8. Resistivity and conductivity.....	35
9. Temperature coefficient.....	37
10. Current control.....	38
11. Conducting materials.....	40
12. Non-conducting or insulating materials.....	42

C. POTENTIAL DIFFERENCE, EMF., AND OHM'S LAW.

13. The meaning of emf.....	44
14. Ohm's law.....	48
15. Sources of emf.....	51
16. Internal voltage drop and line drop.....	56

D. ELECTRIC BATTERIES.

17. General description.....	59
18. Simple primary cell.....	61
19. Types of primary cells.....	63
20. Storage cells.....	67
21. Electrical characteristics of storage cells.....	70
22. Charging and maintenance of storage cells.....	72

TABLE OF CONTENTS.

E. ELECTRIC CIRCUITS.

	Page.
23. Current flow requires a complete circuit.....	76
24. Series and parallel connections.....	77
25. Divided circuits. The shunt law.....	82
26. The potentiometer.....	84
27. The Wheatstone bridge.....	86
28. Heat and power losses.....	87

F. CAPACITY.

29. Dielectric current.....	89
30. Condensers.....	90
31. Dielectric properties.....	91
32. Types of condensers.....	94
33. Electric field intensity.....	97
34. Energy stored in a condenser.....	98
35. Condensers in series and in parallel.....	99

G. MAGNETISM.

36. Natural magnets.....	100
37. Bar magnets.....	100
38. The magnetic field.....	101
39. Magnetic flux and flux density.....	103
40. The magnetic field about a current.....	103
41. The solenoid and the electromagnet.....	104
42. Magnetic induction and permeability.....	105
43. The force on a conductor carrying current in a magnetic field.....	107

H. INDUCTANCE.

44. The linking of circuits with lines of magnetic flux.....	107
45. Induced electromotive force.....	108
46. Self-inductance.....	111
47. Mutual inductance.....	112
48. Energy relations in inductive circuits.....	114

I. ALTERNATING CURRENT.

49. Reactance.....	115
50. Nature of an alternating current.....	116
51. Average and effective values of alternating current.....	118

TABLE OF CONTENTS.

11

	Page.
52. Circuit with resistance only-----	119
53. Phase and phase angle-----	120
54. Alternating current in a circuit containing inductance only-----	121
55. Circuit containing inductance and resistance in series--	123
56. Charging of a condenser in an alternating current circuit-----	125
57. Circuit containing capacity, inductance, and resist- ance in series-----	127
58. The alternating-current transformer-----	128

J. MEASURING INSTRUMENTS.

59. Hot-wire instruments-----	136
60. Magnetic instruments-----	138

K. WIRE TELEGRAPHY AND TELEPHONY.

60a. Wire telegraphy-----	144
60b. Wire telephony-----	145

Chapter 2. Dynamo-Electric Machinery.

61. Generators and motors-----	152
--------------------------------	-----

A. THE ALTERNATOR.

62. Production of emf. by revolving field-----	153
63. Direction of emf-----	153
64. Emf. curve-----	155
65. Cycle, period, frequency-----	155
66. Multipolar magnets-----	156
67. Field and armature-----	156
68. Coil-wound armature-----	157
69. Concentrated and distributed windings-----	159
70. Magnetic circuit-----	161
71. Field excitation-----	162
72. Stator and rotor-----	162
73. Arrangement of parts-----	162
74. Other forms of alternator-----	163
75. Polyphase alternators-----	166

B. ALTERNATOR THEORY, LOSSES AND EFFICIENCY.

	Page.
76. Equations for frequency and emf.....	170
77. Dependence of driving power on current.....	171
78. Losses.....	172
79. Rating; Name-plate data.....	174
80. Efficiency.....	175
81. Regulation.....	176
82. Armature impedance and armature reaction.....	177
83. Effect of power factor on regulation.....	177
84. Effect of speed on regulation.....	178
85. Voltage control.....	179

C. DIRECT-CURRENT GENERATORS.

86. Commutation.....	179
87. Ring and drum winding.....	181
88. Excitation: Separate, series, shunt, compound.....	184
89. Characteristics of terminal voltage.....	186
90. Emf. equation.....	188
91. Voltage control.....	189
92. Effect of varying speed.....	189

D. SPECIAL ALTERNATORS FOR RADIO USES.

93. Audio frequency and radio frequency.....	191
94. Audio-frequency generators.....	192
95. Radio-frequency generators. Alexanderson High-Frequency Alternator.....	204

E. MOTORS.

96. Uses of d. c. and a. c. motors.....	210
97. D. c. shunt motor.....	210
98. D. c. series motor.....	218
99. Other d. c. motors.....	219
100. Combination a. c. and d. c. motors.....	219
101. Alternating current motors. Induction motors.....	219

F. MOTOR-GENERATORS AND DYNAMOTORS.

102. Motor-generators.....	223
103. Rotary converters.....	224

TABLE OF CONTENTS.

13

	Page.
104. Dynamotors.....	226
105. Double-current generators.....	227
106. Common troubles.....	227

Chapter 3. Radio Circuits

A. SIMPLE RADIO CIRCUITS.

107. The simplicity of radio theory.....	231
108. The simple series circuit.....	232
109. Series resonance.....	234
110. Tuning the circuit to resonance.....	240
111. Resonance curves.....	241
112. The wavemeter.....	244
113. Parallel resonance.....	246
114. Capacity of inductance coils.....	250

B. DAMPING.

115. Free oscillations.....	251
116. Frequency, damping, and decrement of free oscillations.....	257

C. RESISTANCE.

117. Resistance ratio of conductors.....	263
118. Brush, spark, dielectric, and radiation resistance.....	266

D. COUPLED CIRCUITS.

119. Kinds of coupling.....	267
120. Double hump resonance curve.....	270
121. Forced oscillations.....	272
122. Free oscillations of coupled circuits with small damping.....	274
123. Impulse excitation. Quenched gap.....	278

Chapter 4. Electromagnetic Waves.

A. WAVE MOTION.

124. Three ways of transmitting energy.....	281
125. Properties of wave motion.....	281
126. Wave trains, continuous and discontinuous.....	285

	Page.
B. PROPAGATION OF WAVES.	
127. Waves propagated by elastic properties of medium---	286
128. Properties of electromagnetic waves-----	287
129. Modification of waves in free space near the earth---	288
130. Difficulties in transmission-----	289
C. THEORY OF PRODUCTION AND RECEPTION OF ELECTROMAGNETIC WAVES.	
131. Magnetic field produced by moving lines of electric displacement-----	294
132. Mechanism of radiation from a simple oscillator---	295
133. Action in receiving -----	298
D. TRANSMISSION FORMULAS.	
134. Statement of formulas-----	299
135. Examples of use-----	301
136. General deductions -----	302
E. DEVICE FOR RADIATING AND RECEIVING WAVES.	
137. Description of the antenna-----	304
138. Different types -----	306
139. Current and voltage distribution in an antenna----	308
140. Action of the ground. Counterpoises-----	309
F. ANTENNA CHARACTERISTICS.	
141. Capacity-----	311
142. Inductance-----	313
143. Resistance -----	313
144. Wave length and its measurement-----	316
145. Harmonics of wave length-----	319
146. Directional effect-----	319
G. ANTENNA CONSTRUCTION.	
147. Towers and supports-----	322
148. Insulators -----	322
149. Antenna switch. Conductors-----	324
150. Grounds and counterpoises-----	326
150a. Ground antennas-----	327

TABLE OF CONTENTS.

15

H. COIL ANTENNAS.

	Page.
151. Coil antennas. Directional characteristics.....	330
152. Direction finders.....	339

**Chapter 5. Apparatus for Transmission and Reception
(Exclusive of Electron Tubes.)**

A. APPARATUS FOR DAMPED WAVE TRANSMISSION.

153. Function of transmitting apparatus.....	353
154. Simple spark discharge apparatus.....	354
155. Transmitting condensers.....	356
156. Spark gaps.....	356
157. Simple induction coil set.....	365
158. Operation of induction coils from power lines.....	366
159. Portable transmitting sets.....	367
160. Simple connections for the production of electric waves.....	367
161. Inductively coupled transmitting set.....	370
162. Direct coupled transmitting set.....	373
163. Comparison of coupled and plain antenna sets.....	373
164. Tuning and resonance.....	375
165. Coupling.....	376
166. Damping and decrement.....	378
167. Additional appliances.....	379
168. Adjustment of a typical set for sharp wave and radiation.....	381
169. Efficiency of the set.....	383
170. Calculations required in design.....	384
171. Simple field measurements.....	389

B. APPARATUS FOR UNDAMPED WAVE TRANSMISSION.

172. Advantages of undamped oscillations.....	396
173. High-frequency alternators.....	397
174. Arc converters.....	400
175. The characteristics of the direct-current electric arc.....	402
176. Production of continuous oscillations by the arc.....	404
177. Construction of arc converters.....	408
178. Signaling methods.....	415

C. APPARATUS FOR RECEPTION OF WAVES.		Page.
179. General principles.....		419
180. Typical circuits for reception of damped waves.....		422
181. Typical circuits for reception of undamped waves....		430
182. Contact detectors.....		433
183. Telephone receivers.....		440
184. Receiving coils and condensers.....		443
185. Measurement of received current.....		448
 Chapter 6. Electron Tubes in Radio Communication. 		
186. The development of the electron tube.....		450
 A. THE ELECTRON FLOW IN ELECTRON TUBES. 		
187. The electron and the two-electrode tube.....		450
188. Ionization in electron tubes.....		452
189. Characteristics of two-electrode tubes.....		454
190. The three-electrode electron tube.....		456
191. Characteristic curves		459
192. Operating characteristics		464
193. Practical forms of three-electrode tubes.....		469
 B. THE ELECTRON TUBE AS A DETECTOR. 		
194. Detector action.....		472
195. Experimental data on detectors		477
 C. THE ELECTRON TUBE AS AN AMPLIFIER. 		
196. General principle of amplification.....		479
197. Elementary theory of amplification.....		482
198. Audio-frequency amplification		484
199. Regenerative amplification		487
200. Electron tube amplifier with crystal detector.....		488
 D. THE ELECTRON TUBE AS A GENERATOR. 		
201. Conditions for oscillation.....		489
202. Circuits used for generating oscillations.....		491
203. Practical considerations in using electron tubes as generators		492
204. Alternating-current plate supply.....		498
205. Beat reception.....		501

TABLE OF CONTENTS.

17

E. RADIO TELEPHONY.

	Page.
206. The wave forms used in radio telephony-----	507
207. Methods of modulation-----	516
208. Modulation of electron tube generators-----	519
209. Operation of tube radio telephone transmitting sets--	525
210. Practical forms of apparatus-----	527
211. Chopper modulation of tube transmitting sets for radio telegraphy-----	529
212. Line radio communication -----	530

Appendices.

APPENDIX 1. SUGGESTED LIST OF LABORATORY EXPERIMENTS..	537
APPENDIX 2. UNITS -----	547
APPENDIX 3. SYMBOLS USED FOR PHYSICAL QUANTITIES---	552
APPENDIX 4. COPPER WIRE TABLES-----	554
APPENDIX 5. WAVE-LENGTH TABLE-----	557
APPENDIX 6. RADIO LAWS AND REGULATIONS-----	561
APPENDIX 7. INTERNATIONAL CODE, CONVENTIONAL SIGNALS, AND ABBREVIATIONS-----	565
APPENDIX 8. RADIO PUBLICATIONS-----	568
APPENDIX 9. SAFETY PRECAUTIONS -----	578
INDEX -----	581

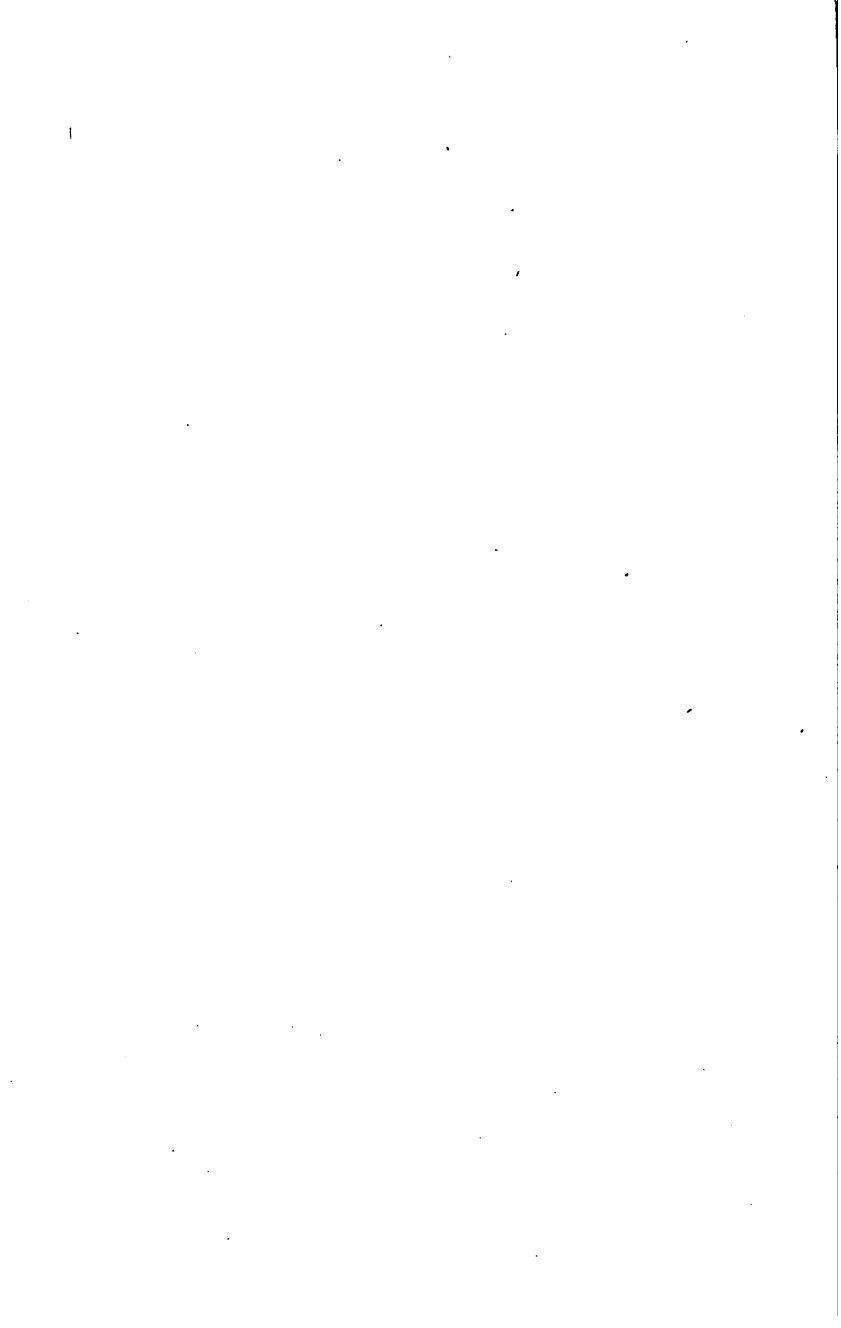

INTRODUCTION.

1. **What Radio Communication Means.**—In military service all possible means of communication are used, including the most primitive. Some of the earliest methods were by means of beacon fires, and, much later, flags. However, the best and most rapid are the electrical methods. These include the ordinary wire telegraph and telephone and the wireless or radio apparatus. Without wire connecting lines, radio messages are sent from one point to another on the battle front, from ship to shore, across the oceans, to airplanes, and even to submerged submarines. Business and social life have been profoundly modified by the advent of electric communication, and recent developments in radio have done much to make communication easy between distant points.

When a pebble is thrown into the smooth water of a pond it starts a series of circular ripples or waves, which spread out indefinitely with a speed of a few hundredths of a meter¹ per second (see the frontispiece). Similarly, an electric disturbance starts electric waves, which spread out in all directions, and travel with the velocity of light, which is 300,000,000 meters per second, or about 186,300 miles per second. It is by means of these electric waves that radio messages are sent.

In order to make use of electric waves for the practical purpose of sending messages, it is necessary—

(a) To produce regular electric disturbances in a circuit which start the waves. (These disturbances are electric currents which reverse rapidly in direction.)

(b) To get the waves out into surrounding space, through which they travel with great speed. (This is done by means of the transmitting antenna.)

(c) By means of these waves, to set up electric currents in a receiving circuit at the distant station. (The device which these waves strike as they come in, and which turns them over to the receiving circuit, is called the receiving antenna.)

¹ The meter and other units are explained in Appendix 2, p. 547.

(d) To change these currents so that they may be detected by electric instruments. (The operator usually receives the message through signals in a telephone receiver.)

In communication by flags, messages are transmitted by a "code" in which each letter of the alphabet is represented by a position or combination of positions of flags.² In communication by radio telegraphy, a code is used consisting of combinations of very short signals, or "dots," and longer signals, or "dashes." In communication by radio telephony, the voice itself is transmitted, and no code is necessary.

The student of radio communication needs a more thorough knowledge of electrical theory than that needed for some branches of electrical work. This fact needs emphasis for the beginner. Of course a man can learn to operate and care for apparatus without having a real understanding of its underlying principles. It only requires that he have a certain type of memory, industry, and a little common sense. But a man with only this kind of knowledge of his subject is of limited usefulness and resourcefulness, and can not advance very far. The real radio man must have some training in the whole subject of electricity and magnetism, as well as a rather intimate familiarity with some restricted parts of it. An understanding of radio communication requires some knowledge of the following subjects:

(a) Direct and alternating currents and dynamo machinery.

(b) High-frequency alternating currents, including the subject of condenser discharge.

(c) Conduction of electric current in a vacuum as well as in wires.

(d) Electric waves, which involve some acquaintance with modern ideas of electricity and the ether.

(e) The apparatus used for the production and reception of electric waves.³

² See "Visual Signaling," Signal Corps Training Pamphlet No. 4. Information regarding visual signaling is also contained in a book by J. A. White, "Military Signal Corps Manual."

³ The reader who desires an introductory discussion of the fundamentals of electrical phenomena may consult Signal Corps Training Pamphlet No. 1, "Elementary Electricity." The reader who desires a briefer and more elementary discussion of the principles of radio

2. **Fundamental Ideas of the Electric Circuit.**—It is common knowledge that a battery supplies what is known as a current of electricity. To obtain the current there must be a complete, closed, conducting path from the battery through the apparatus which is to be acted on by the current, and back again to the battery.

For example, when connecting up an electric bell, a wire is carried from one binding post of the battery (Fig. 1) to one of the binding posts of the bell, and a second wire is brought from the other binding post of the bell back to the remaining binding post of the battery. Any break in the wire immediately causes the current to stop and the bell to be silent. This furnishes an easy method of controlling the ringing of the bell, since it is only necessary to break the circuit at one point to stop the current, or to connect across the gap with a piece of metal to start the current going again. Thus the battery supplies the power to operate the bell, and the button opens and closes the circuit and thus controls the delivery of that power to the bell. Similar considerations apply when using the city lighting circuit. Wires from the generator at the central station are brought to the lamp, motor, or heating device to be supplied, and the flow of current to this device controlled by means of a switch. The switch consists of pieces of metal which may be brought into contact when desired. The operation of the switch makes or breaks the contact. One handle may control two switches, so that with one motion the circuit can be broken at two places. The switch may be located on the wall and be of any one of a number of different forms, such as the "snap switch," the "push-button switch," and the "knife switch." The switch may be located in the socket which holds the lamp; such a socket is called a "key socket." It makes no difference at which part of the circuit the current is interrupted. The flow of current will stop whether the break is made at the lamp, or in one wire at some distance from the lamp, or by opening a switch at the switchboard at the central

communication may consult Signal Corps Radio Communication Pamphlet No. 1. Copies of either of these pamphlets may be procured from the Superintendent of Documents, Government Printing Office, Washington, D. C., for 15 cents for the former and 10 cents for the latter.

See also pp. 569, 575.

station. Electricity must then be regarded as flowing in every part of the circuit, so that electricity is leaving the battery or dynamo at one side and going back to it at the other side.

Current.—The current flowing in a circuit is no stronger at one point of the circuit than at another. This can be proved by connecting a measuring instrument called an ammeter into the circuit at different points, *a*, *b*, or *c*, Fig. 2. It is found to register the same at whatever point this test is made. A useful illustration of the electric circuit is a closed circuit of pipe (Fig. 3) completely filled with water and provided with a pump, *P*, or some other device for causing the water to circulate. The

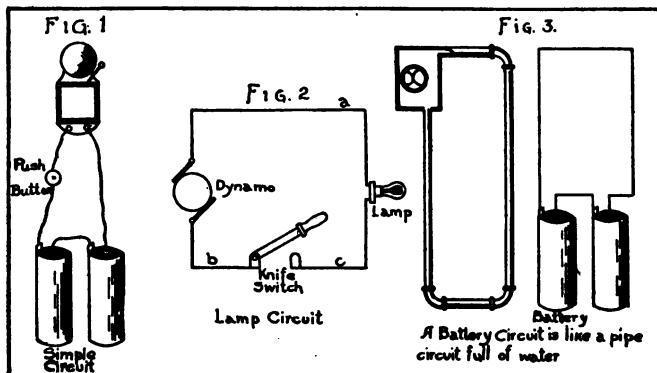

amount of water which leaves a given point in each second is just the same as the amount which arrives in the same length of time. Now in the electric circuit we have no material fluid, but we suppose that there exists a substance, which we call electricity. Electricity behaves in the electric circuit much like an incompressible fluid in a pipe line. We are very sure that electricity is not like any material substance which we know, but the common practice among students and shopmen of calling it "juice" shows that they think of it as like a fluid. We will, then, imagine the electric current to be a stream of electricity flowing around the circuit.

One way of measuring the rapidity with which water is flowing is to let it pass through a meter which registers the total

number of quarts or gallons which pass through. By dividing the quantity by the time it has taken to pass we obtain the rapidity of flow. There are instruments by means of which it is possible to measure the total quantity of electricity which passes any point in the circuit during a certain time. If we divide this quantity by the time, we obtain the amount of electricity which has passed in one second. This is a measure of the current strength.

In practical work, however, the strength of the current is measured by instruments (ammeters) which show at each moment just how strong the current is, in somewhat the same manner as we may estimate the swiftness of a stream by watching a chip on the surface. This kind of an instrument enables us to tell at a glance what the current is without the necessity for a long experiment, and further we may detect changes in the strength of the current from moment to moment. In this connection it will be remembered that two measuring instruments are to be found on an automobile. The speedometer shows what the speed of the car is at each moment, so that the driver may know instantly whether he is exceeding the speed limit, and govern himself as he sees fit. The other instrument shows how many miles have been covered on the trip, and of course the average speed may be calculated from its indications, if the length of the trip has been timed. The instrument for measuring total quantity of electricity corresponds to the recorder of the total miles traversed; the ammeter corresponds to the speedometer.

Electromotive Force.—The water will not flow in the pipe line, Fig. 3, unless there is some force pushing it along—as, for example, a pump—and it can not be kept flowing without continuing the pressure. Electricity will not flow in a circuit unless there is a battery or other source of electricity in the circuit. The battery is for the purpose of providing an electric pressure. To this is given the name “electromotive force”—that is, a force which moves the electricity. This is usually abbreviated to “emf.” The larger the number of cells which are joined in the circuit in such a way that their pressures will add, the greater the electric pressure in the circuit and the larger the current produced, just as the rapidity of flow of the water in the pipe line may be increased by increasing the pump pressure.

Resistance.—There is always some friction in pipe, whatever its size or material, and this hinders the flow of the water to some extent. If it were not for the friction, the water would increase indefinitely in speed. Similarly, there is friction in the electric circuit. This is called the “resistance” of the circuit. The greater the resistance the smaller the current which can be produced in the circuit by a given battery, just as the greater the friction the less rapid the flow of water with a given pump acting. A resistance coil at any point in the circuit corresponds to a partially closed valve in the pipe at any point (Fig. 4).

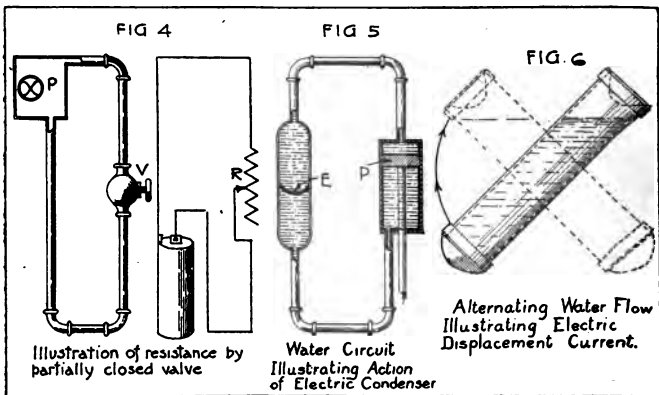

Steady and Variable Currents.—If a pipe is connected to a large reservoir of water maintained at the same level, the steady pressure of the constant head of water will cause a steady flow of water in the pipe. The quantity of water which will pass a given point in one second will be the same at all times. Certain sources of electricity, such as batteries and some kinds of dynamos, produce an electromotive force which is practically constant, and will cause a practically constant current to flow in circuits to which they are connected. A steady electric current in one direction is called a “direct current.”

In the case of the ordinary force pump, the water is given a succession of pushes all in the same direction but separated by intervals when the water is not being pushed. The heart is

such a pump which applies successive impulses to the blood and causes it to circulate. A pipe supplied by a force pump is usually discharging some water all the time, but successive spurts occur when an unusually large stream of water is discharged for a moment, the frequency of these spurts corresponding to the rate at which the pump is being run. Similarly, there are sources of electromotive force which act intermittently. When such an electromotive force is connected to a circuit, the current flows always in the same direction but varies in magnitude from instant to instant. A current of this kind, which pulsates regularly in magnitude, is called a "pulsating current."

A very important kind of current for radio work is that known as "alternating current." This is analogous to the kind of flow which would be produced if, instead of being acted on by a pump, the water were agitated by a paddle which moved back and forth rapidly over a short distance, without traveling beyond certain limits. Under this impetus the water no sooner gets up speed in one direction than it is compelled to slow up and then gather speed in the opposite direction, and so on over and over again. The water simply surges, first in one direction, and then in the other, so that a small object suspended in the water would not travel continuously around the pipe line, but would simply oscillate back and forth over a short distance.

Effect of Condenser.—As a further case, let us suppose that an elastic partition E is arranged in the pipe (Fig. 5), so that no water can flow through or around it. If a pump P , or a piston, acts steadily, the water moves a short distance until the partition is stretched enough to exert a back pressure on the water equal to the pressure of the pump, and then the movement of the water as a whole ceases. If, on the contrary, a reciprocating motion is given to the water by P , the water moves back and forth, stretching the partition first in one direction and then in the other, and the water surges back and forth between short limits which are determined by the elasticity of the partition. We have in this case an alternating current of water in spite of the presence of the partition.

An electric condenser acts just like an elastic partition in a circuit. No direct current can flow through it, but an alter-

nating current, of an amount depending on the nature of the condenser, can flow when an alternating emf. acts on the circuit.

As an extreme case, we may imagine the pipe line replaced by a long tube filled with water and the ends closed by elastic walls (Fig. 6). Suppose an alternating pressure to be given to the water in the tube, or even let the tube be tipped, first in one direction and then in the other. The water will oscillate back and forth a short distance in the tube, first stretching the wall at one end and then the wall at the other. A small alternating flow is thus set up, although there is not a complete circuit for the water to flow through. Analogous to this case is that of the electrical oscillation in an antenna. Such a flow of electricity without a complete conducting circuit is called a "displacement current." It is always necessary, in order to produce a displacement current, that the circuit shall have electrical elasticity somewhere; that is, that an electric condenser shall be present.

The importance of the electric current lies in the fact that it is an energy current. A current of water transports energy; so does a current of air. It is the motion that counts, and to utilize the energy of motion we must do something tending to stop the motion. In the case of water flowing in a channel we may do this by causing the water to flow under a water wheel whose resistance to turning causes it to absorb energy from the current of water.

Any material substance, by virtue of its mass, can be made to act as a vehicle for transporting energy from one place to another provided only it is set into motion. In the case of the electric current, we do not need to inquire whether electricity has mass. We are concerned, in the use of electrical apparatus, with the transformation of the energy of the current into other familiar forms of energy—heat, light, and motion. The electric current is the vehicle by which we transmit energy from the central station to the consumer, and we are not, for practical purposes, concerned with the method of carrying the energy, any more than we need to inquire into the nature of the belt by which mechanical energy is carried from one wheel to another, or into the chemical nature of the water which is furnishing the power in a hydraulic plant.

The electric current itself can not be seen, felt, smelt, heard, or tasted. Its presence can be detected only by its effects—that is, by what happens when it gives up some of its energy. Thus, an electric current may give up some of its energy, and cause a motor to turn. Electrical energy has been given up, and mechanical energy takes its place. Similarly, electric energy may disappear and heat or light may appear in its place, or a chemical effect may arise. When a person feels an electric shock, it is not the current itself he feels, but the muscular contractions and other physiological effects caused by the passage of the current. The electric lamp has an effect on the eye. We do not, however, see the electric current in the lamp, but the effect on the eye is due to the light waves sent off by the hot filament. The energy of the current has been changed over into heat in the lamp. When we hear a sound in the telephone receiver it is not the electric current we hear, but merely the vibration of the thin diaphragm. The electric current has used some of its energy in causing the diaphragm to vibrate. The acid taste noticed when the tongue is placed across the poles of a dry battery is due to the chemical decomposition of the saliva into other compounds as a result of the passage of the current through it.

In the next section, the electric current is studied through the effects it produces, and in later sections it is given a more exact and detailed treatment.

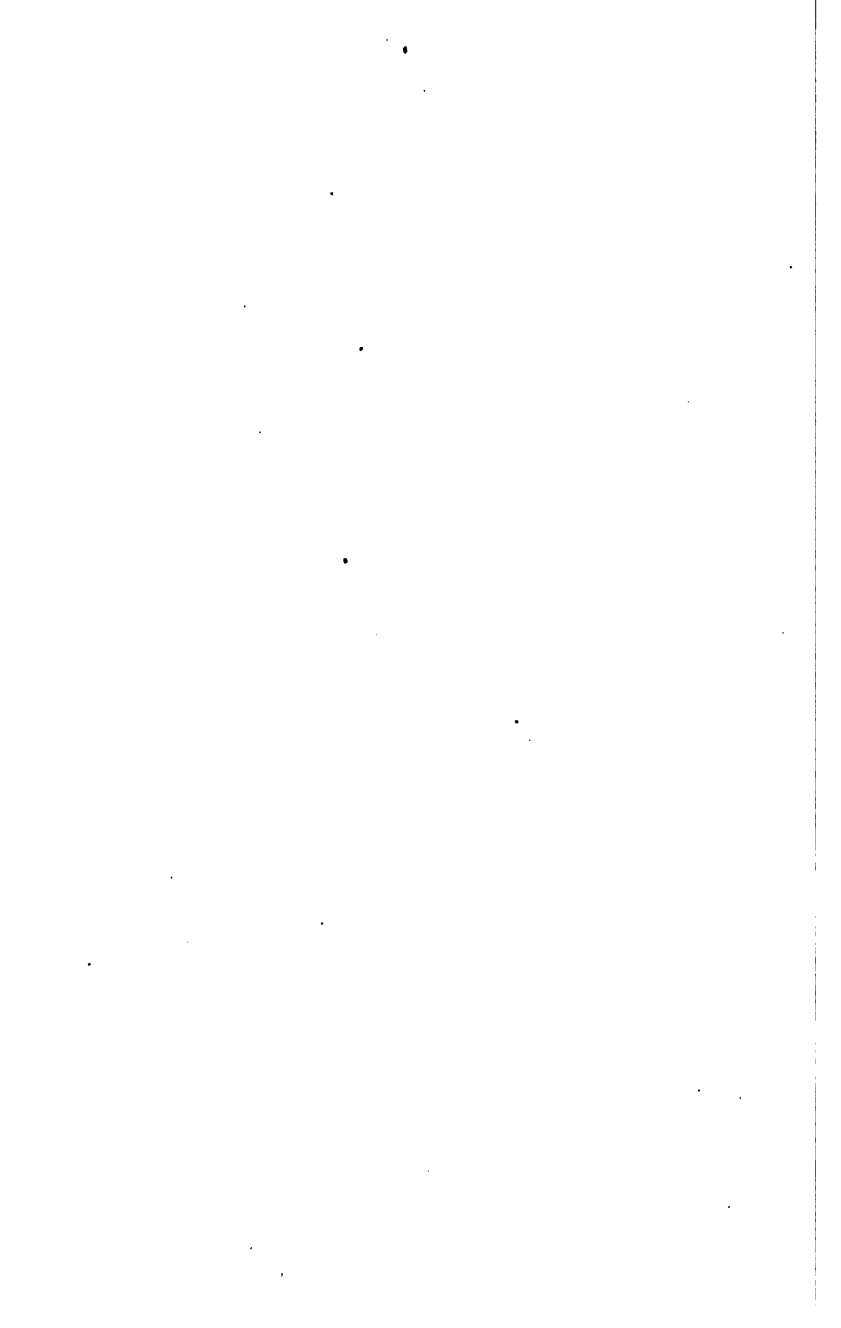

CHAPTER 1.

ELEMENTARY ELECTRICITY.

A. Electric Current.

3. **Effects of Electric Current.**—Most of the applications of electricity depend upon the *movement* of electricity; that is, the electric current. The effects of stationary electricity (electric charge or quantity of electricity) are of importance in connection with such subjects as electric condensers (see Sec. 30), and in the study of electrons, but it is moving electricity, or current flow, that is of greatest practical importance.

A wire in which an electric current is flowing usually looks exactly like a wire without current. Our senses are not directly impressed by the phenomena of electricity, and hence it is necessary to depend upon certain effects which are associated with the flow of current through a conductor when it is desired to determine whether or not a current exists. Some of these effects are as follows:

(a) If a straight wire carrying an electric current is brought near a small magnet, such as a compass needle, which is so placed that the axis about which it turns is parallel to the axis of the wire (Fig. 7), then the needle is deflected a certain amount and tends to become tangent to a circle about the wire. It then remains in the new position as long as the current does not vary.

(b) A wire with a current passing through it will be at a higher temperature than the same wire before the current flows. If the wire is large or the current is small, this can be detected only by a sensitive thermometer, but under some conditions, as in an ordinary incandescent lamp, the rise of temperature is so great as to cause the wire to glow.

(c) If the wire through which the current is flowing is cut and if the separated ends are immersed in a solution in water of any one of a wide variety of substances, there will be a chemical change in the solution. This chemical change may become apparent by a change in the color of the solution, by a deposit

on one of the wires, or otherwise, and gas may be evolved. Thus, if the solution is copper sulphate, copper will be deposited.

The attention of the student should be fixed upon these effects of the current, rather than upon the current itself. It is in terms of these effects that electric currents are detected, measured, and applied. Thus the magnetic effect is the basis of dynamo-electric machinery and radio communication; the heating effect (*b*) makes possible electric cooking and electric lighting; and the chemical effect (*c*) makes possible electroplating, electric batteries, and various chemical processes. All three effects are utilized in making electric measurements.

It must be kept in mind that such expressions as "flow" and "current" and many other electrical terms are merely survivors from an earlier day when electricity was supposed to be a fluid which actually flowed. Such terms are, however, helpful in forming mental pictures of the real phenomena of electricity. Attention must always be centered on the facts and effects which these terms represent and the words or phrases themselves must not be taken literally.¹

4. **Direction of Current.**—By means of the magnetic effect it is readily shown that electric current has direction. If the wire in Fig. 7 be withdrawn from the plate, *O*, and reinserted in the opposite direction, the compass needle will indicate a direction (Fig. 8) nearly opposite to that of its original position. The same result is secured if the wire is left unchanged and the connections to the terminals of the battery are reversed.

The direction of flow of electric current is a matter of arbitrary definition, and in practice the student will usually determine the direction by means of an instrument with its terminals marked + and -. It is assumed that current enters the instrument at the + terminal and leaves it at the - terminal.

The magnetic effect may also be used in specifying the direction of the current. See Section 40, page 103. Again referring to Fig. 7, it is seen that as the current flows down through the plane, the compass needle, at every point in the plane, tends to set itself tangent to one of the concentric circles about the wire.

¹ Read Franklin and MacNutt, General Physics, p. 238.

As the observer looks along the conductor in the direction in which the current is flowing, the north-seeking or north-pointing pole of the needle will point in a clockwise direction around the conductor—that is, it will point in the direction it would assume if following the advancing hand of a clock having the conductor as a pinion. Other useful rules for remembering the same relative directions are as follows:

(a) Grasp the wire with the right hand and with the thumb extended along the wire in the direction of the current. The

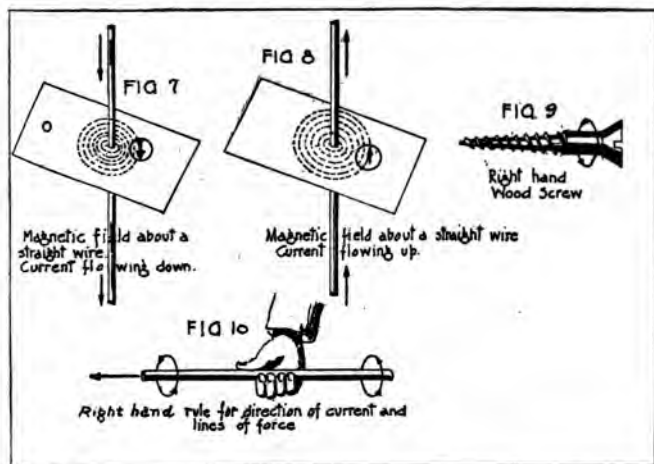

curved finger tips will then indicate the direction of the magnetic effect, Fig. 10.

(b) Imagine an ordinary right-hand wood screw being advanced into a block in the direction in which the current is flowing (Fig. 9). The direction in which the screw rotates then indicates the direction of the magnetic field around the wire or conductor as it would be indicated by a compass needle.

The student should assure himself of complete familiarity with one of these rules by considerable practice with a small compass and a simple electric circuit.

For the extension of this relation to determine the polarity of a helical coil carrying a current, see section 42, page 105.

5. **Measurement of Electric Current and Quantity of Electricity.**—All three of the simple ways by which electric current may be detected (see Sec. 3) provide means of current measurement. The magnetic effect of the current may be used by mounting a wire and a magnet in such positions that when a current flows in the wire either the magnet or the wire moves. The heating effect of the current is utilized in hot-wire instruments (Sec. 59), where the increase in length of the heated wire is utilized to move a pointer over a dial. These principles are used in a great variety of instruments for the measurement of current. The amount of current is read from the scale or dial of the instrument. The scale is usually graduated at the time when the instrument is standardized, in a unit² called the "ampere." The instruments are called "ammeters."

The ampere is a unit the magnitude of which has been defined by international agreement. In its definition the third effect of the electric current, described above, is made use of. The mass of a metal which is deposited out of a solution by an electric current depends on the product of the strength of the current by the time it is allowed to flow. Thus a certain current flowing for 100 seconds is found, experimentally, to be able to deposit as much of a metal as a current 100 times as great passing for one second, etc. Remembering that the strength of the current is the rapidity of flow of electricity, it is evident that the product of strength of current by time of flow gives the total quantity of electricity which has passed.

The mass of a metal deposited by the current is, then, proportional to the total quantity of electricity which has flowed through the solution. Equal quantities of electricity will deposit different masses of different metals, but the mass of any chosen metal is always the same for the same quantity of electricity.

The ampere (properly called the international ampere) is that unvarying current which, when passed through a neutral solution of silver nitrate, will deposit silver at the rate of 0.001118 gram per second.

A convenient way of remembering this figure is that it is made up of one point, two naughts, three ones, and four twos—8. While current could be regularly measured by the process used in establishing this unit this is not done in actual practice.

² See Appendix 2 on "Units," p. 547.

The measuring instruments used in actual measurements are, however, standardized more or less directly in terms of the unit thus defined.

Quantity of electricity is usually measured in a unit called the "coulomb." The coulomb is the quantity of electricity transferred by a current of one ampere in one second. Another unit sometimes used for measuring quantity of electricity is the "ampere-hour," which is the quantity of electricity transferred by a current of one ampere in one hour, and is therefore equal to 3,600 coulombs.

6. Electrons.—When electric current flows in a conductor there is a flow of extremely small particles of electricity, called electrons. The study of these particles is important not only in connection with current flow, but also in light and heat and chemistry. The reason for this is that all matter contains them. Matter of all kinds is made up of atoms, which are extremely small portions of matter (a drop of water contains billions of them). The atoms contain electrons which consist of negative electricity. The electrons are all alike, and are in turn much smaller than the atoms. Besides containing electrons, each atom also contains a certain amount of positive electricity. Normally the positive and negative electricity are just equal. However, some of the electrons are not held so firmly to the atom but what they can escape when the atom is violently jarred. When an electron leaves an atom there is then less negative electricity than positive in the atom; in this condition the atom is said to be positively charged. When, on the other hand, an atom takes on one or more extra electrons it is said to be negatively charged.

The atoms in matter are constantly in motion, and when they strike against one another an electron is sometimes removed from an atom. This electron then moves about freely between the atoms. Heat has an effect upon this process. The higher the temperature, the faster the atoms move and the more electrons given off. If a hot body is placed in a vacuum the electrons thus given off travel from the hot body out into the surrounding space. This sort of a motion of electrons is made use of in the electron tube, which is the subject of Chapter 6 of this book. The motion of the electrons inside a wire or other conductor is the basis of electric current flow. This is discussed,

with the various important properties of electrons, in a book by R. A. Millikan, "The Electron," and, briefly, in "Radio Instruments and Measurements," Circular No. 74 of the Bureau of Standards, page 8. (This circular is sometimes referred to as C. 74.)

B. Resistance and Resistivity.

7. **Resistance and Conductance.**—The flow of current through a circuit is opposed by a property of the circuit called its "resistance" (symbol R). The resistance is determined by the kinds of materials of which the circuit is made up, and also by the form (length and cross section) of the various portions of the circuit. Provided that the temperature is constant, the resistance is constant, not varying with the current flowing through the circuit. This important relation is called Ohm's law and will be discussed further in Sec. 14. All substances may be grouped according to their ability to conduct electricity, and those through which current passes readily are called "conducting materials" or "conductors," while those through which current passes with difficulty are called "insulating materials" or "non-conductors." However, there is no known substance which admits current without any opposition whatever, nor is there any known substance through which some small current can not be made to pass. There is no sharp distinction between the groups, as they merge gradually one into the other. Nevertheless, it should be kept in mind that conductors have a conducting power which is enormously greater than the conducting power of an insulator. The minute current which can be forced through an insulator under certain circumstances is aptly called a "leakage current." An ideal insulator would be one which would allow absolutely no current to flow. Examples of good conducting materials are the metals and that class of liquid conductors called electrolytes. Examples of insulating materials are dry gases, glass, porcelain, hard rubber, and various waxes, resins, and oils.

A circuit which offers but little resistance to a current is said to have good conductance. Representing this by g we may write

$$g = \frac{1}{R}; \text{ or } R = \frac{1}{g} \quad (1)$$

For example, a circuit having a resistance of 10 ohms will have a conductance of 0.1 and one of 0.01 ohm will have a conductance of 100. The unit of resistance called the "ohm" is defined in terms of a standard consisting of pure mercury, of accurately specified length, mass, and temperature.

The international ohm is the resistance offered to the flow of an unvarying current by a column of mercury 106.3 centimeters high and weighing 14.4521 grams at a temperature of 0°C.

For very small resistances the millionth part of an ohm is used as a unit and is called the "microhm." For high resistances a million ohms is used as a unit and is called the "megohm."

The opposition to flow of current referred to above is analogous to friction between moving water and the inner surface of the pipe through which it flows. It is always accompanied by the production of heat. If an unvarying current is maintained through a conductor, this production of heat is at a constant rate. The total heat, produced in t seconds, is found to be proportional to the resistance of the circuit, to the square of the current, and to the time, thus

$$W=RI^2t \quad (2)$$

From this it follows that R , for a given portion of the circuit, might be measured by the heat generated in that portion. The heat will be measured in "joules" when the current is in amperes, the resistance in ohms, and the time in seconds. To find the heat in calories, the relation $W/J=H$ will be used, where W is in joules and J (4.18) is the number of joules in one calorie. The relation given in equation (2) is sometimes called Joule's law.

8. Resistivity and Conductivity.—For a given piece of wire of uniform cross section, its resistance is found to be proportional directly to its length, and inversely to its cross sectional area; and in addition the resistance depends upon the kind of material of which the wire is composed. These relations may be expressed by the following equation

$$R=\rho \frac{l}{s} \quad (3)$$

where R is the measured resistance of the sample, l is the length, s is its cross section and ρ is a constant, characteristic of the given material. Solving this equation for ρ we have

$$\rho = R \frac{s}{l} \quad (4)$$

If a piece of material is chosen having unit cross section and unit length, it is seen that ρ is equal to the resistance of the piece, measured between opposite faces. The factor ρ is called the "resistivity" or "specific resistance" of the substance, and is defined as the resistance between opposite faces of the unit cube. The ohm or the microhm is commonly used as the unit of resistance and the centimeter as the unit of length. Instead of expressing resistivity in these units it may also be given in terms of ohms per foot of wire one mil (0.001 inch) in diameter, or in ohms per meter of wire one millimeter in diameter.

Another group of resistivity units is based upon the mass of a sample instead of its volume, for example: (a) the resistance of a uniform piece of wire of one meter length and of one gram mass; or (b) the resistance of a wire of one mile length and of one pound mass. Practically, for some purposes, the mass resistivity is preferable to the volume resistivity for the following reasons: (a) sufficiently accurate measurements of cross section of specimens are frequently difficult, or, for some shapes, impossible; (b) material for conductors is usually sold by weight rather than volume, and hence the data of greatest value are most directly given. The mass units and volume units are readily interconverted, provided that the density of the material is known. If in equation (3) we substitute for s the value of $\frac{v}{l}$, where v is the volume, and for v its equivalent $\frac{m}{d}$, where m is the mass and d is the density, we have

$$R = \rho d \frac{l^2}{m} \quad (5)$$

The quantity ρd is called the mass resistivity of the material. The volume resistivity may then be transformed into mass resistivity, or vice versa, taking care that all the quantities are given in consistent units. As examples of resistance the following will be useful:

1. One ohm is the resistance of about 157 feet of number 18 copper wire (diameter about 1 mm., or 40 mils or 0.04 inch).

2. One thousand feet of number 10 iron wire (diameter about 2.5 mm., or 102 mils or 0.1 in.) has a resistance of about 6.5 ohms.

Tables of resistivity for various materials are given in Table 21, Circular 74 of the Bureau of Standards.

Just as conductance is the reciprocal of resistance when considering the properties of a circuit as a whole, so "conductivity" is the reciprocal of resistivity when considering the properties of a given material. Its unit is the "mho," or "reciprocal ohm."

9. **Temperature Coefficient.**—The electrical resistance of all substances is found to change more or less with any change in temperature. All pure metals and most of the metallic alloys show an increased resistance with rising temperature. Carbon and most liquid conductors like battery solutions show a decrease in resistance as the temperature increases. Experiment shows that the resistance at a temperature t can be calculated, if the resistance at zero temperature (melting point of ice) has been measured. The formula is

$$R_t = R_0 + R_0 \alpha_0 t \quad (6)$$

where R_0 is the resistance of the sample at zero, and α_0 is the change in 1 ohm when the temperature changes from zero to 1° C. The factor α_0 is called the "temperature coefficient" of resistance for the material. Solving equation (6) for α_0 we have

$$\alpha_0 = \frac{R_t - R_0}{R_0 t} \quad (7)$$

Equation (7) shows α_0 is the value of the change in the resistance per ohm per degree change in temperature, or it is the fractional change of the total resistance for 1 degree change in temperature. If the resistance of the material decreases with a rise in temperature, then the temperature coefficient is negative.

If a reference temperature t_1 is chosen, which is not zero, then the resistance R_2 , at some other temperature t_2 , which is higher than t_1 , may be found from the resistance R_1 at t_1 by the following equation,

$$R_2 = R_1 [1 + \alpha_1 (t_2 - t_1)] \quad (8)$$

where α_1 is the temperature coefficient for the reference temperature t_1 .

Calculations of this sort are simplified by the use of a table of values of α for various initial reference temperatures. See Table 21, Circular 74.

10. **Current Control.**—In electrical work the need is constantly arising for adjusting a current to a specified value. This is usually done by varying the resistance of the circuit. Changes in the resistance of a circuit can be made by means of resistors, which consist in general of single resistance units, or groups of such units, made of suitable material. These may be variable or fixed in value. Variable resistors are frequently

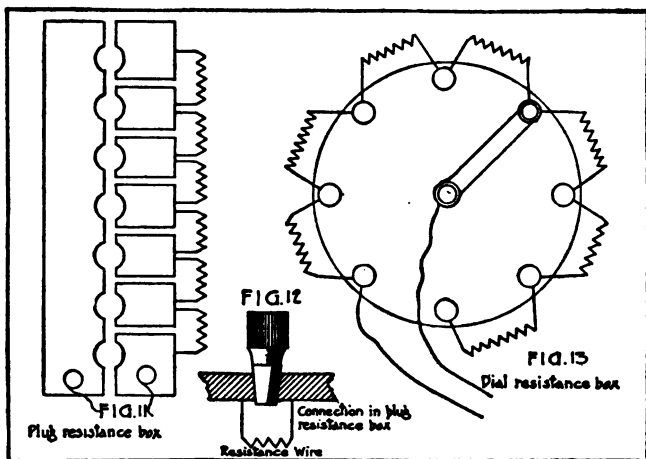

called "resistance boxes" or "rheostats," depending on their current-carrying capacity and range.

A resistance box consists of a group of coils of wire assembled compactly in a frame or box. (Figs. 11, 12, and 13.) It is so arranged that single coils or any desired combination of such coils may be introduced into the circuit by manipulating the switches or plugs. The extreme range of such a device may be from a hundredth or a tenth of an ohm up to 100,000 ohms. Each of its component units is accurately standardized and marked with its resistance value. By this means it is possible to know precisely what resistance is introduced into the circuit by the resistance box. The coils are wound with

relatively fine wire, and in such a way that they do not have any appreciable magnetic fields about them. They are intended solely for carrying feeble currents, usually no more than a fraction of an ampere.

Resistors of single fixed values are convenient for many purposes. If they are carefully made and precisely measured, they are called standard resistance coils. Such standards may be secured in range from 0.00001 ohm to 100,000 ohms and of any desired current-carrying capacity and degree of precision. Resistance boxes and precision resistors are designed primarily for use in the laboratory.

The name "rheostat" is, in general, applied to a variable resistor having a fairly large current-carrying capacity. A

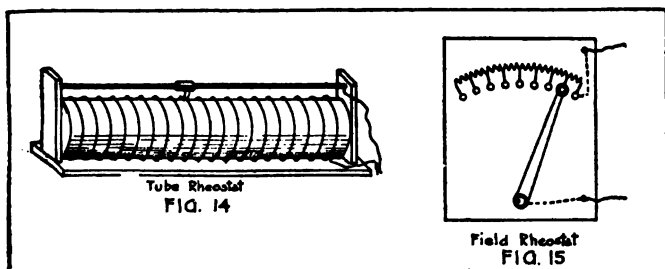

simple form of rheostat consists of a layer of German silver or nickel-steel wire wound on an insulating tube with a sliding contact traveling along the tube so that the current may be made to pass through any desired length of the wire. (Fig. 14.) Such rheostats are not usually made to handle large amounts of power. Larger rheostats are made of resistance units connected between the points of a switch, as shown in Fig. 15. The units are made of resistance wire embedded in vitreous enamel on a metal plate or wound on a porcelain tube and then enameled. For very large units the resistors are made in the form of grids of cast iron, nickel steel, or similar metal, which are exposed to the air for cooling. The grid type of resistor is by far the most common in commercial use, especially for railway and electric-crane control. For extremely large currents a convenient compact rheostat is made by immersing metal plates to a variable depth in a conducting

liquid; such a liquid rheostat can be easily cooled by using a metal container, or by changing the liquid as it becomes heated.

Banks of incandescent electric lamps in various arrangements are often used as resistors. The resistance of such lamps is subject to large variations in value with changes in temperature. However, when operating under steady conditions, either hot or cold, they are satisfactory for many purposes. Such a rheostat offers the advantage of being readily adjustable by turning lamps off or on. It is compact and there is no danger of overheating.

Another type of rheostat for handling large currents consists of a pile of carbon blocks or plates which are compressed by a screw or lever to reduce their electrical resistance.

11. **Conducting Materials.**—Conducting materials, usually metals or metallic alloys, are utilized in electric circuits with two different purposes in view. In one case a high degree of conductivity is required, while in the other case relatively high resistivity is desired. These cases will be discussed in turn.

(a) If the conductor is transmitting energy to a distant point by means of the electric current, it is seen from equation (2) that some energy will be wasted in the conductor in the form of heat. This loss should be kept as small as possible, and to this end great care is taken in choosing the size and material of the conductor. For reasons of economy the cross section must not be too great, hence a desirable material for conducting lines must have low resistivity and must be abundant and relatively cheap to produce. Such a material is copper. Where lightness is important and where increased dimensions are not a disadvantage, aluminum is much used. Steel is used where great strength is desired and where the current is small, as in telegraph lines. For lines which must stand great strain and at the same time be good conductors, such as radio antennas, a stranded phosphor bronze wire is often used.

(b) A material to be used for resistor coils, on the other hand, should have the following properties:

1. The resistivity should be fairly high so that a large resistance may be obtained without too great a bulk.
2. The material should remain strong mechanically when heated.

3. The cost of material should not be excessive.

For precision rheostats for careful laboratory measurements the following qualities, which are of comparatively small importance for ordinary electrical engineering work, should also be considered:

4. The temperature coefficient must be small, so that heating does not change the resistance appreciably.

5. The resistivity must not change with time, even when the unit is heated for long periods.

6. The thermoelectric force (Sec. 15) between the chosen material and copper or brass must be small, so that the contacts between the different parts of the circuit will not cause troublesome thermoelectric currents.

Iron is by far the most common material used in rheostats, since it is cheap, strong, and has a fairly high resistance. It is used in the form of grids for street car, locomotive, train, elevator, and crane control and in the form of wire coils for handling smaller powers. German silver and the various nickel steels rank next in frequency of use and, with iron, make up the great bulk of commercial rheostats. Special alloys, such as those called "manganin" and "invar," are used for laboratory units where the last three requirements mentioned above must be met. Table 21, of Circular 74 of the Bureau of Standards, gives the properties of some pure metals and the composition and electrical properties of certain of the more common alloys.

Wire Gauges.—Sizes of wires are specified in two general ways, either by giving the actual diameter in millimeters or in mils (1 mil=0.001 inch), or by assigning to the wire its place in an arbitrary series of numbers called a wire gauge. Only two of these arbitrary wire gauges are of importance in American practice, the American Wire Gauge and the Steel Wire Gauge. To avoid confusion the name of the gauge must always be given with the gauge number. Most steel wire is specified in terms of the steel wire gauge. Wire used in electrical work, such as copper, aluminum, and the copper-nickel alloys, is specified in terms of the American Wire Gauge. This is the only gauge in which the successive sizes have a definite mathematical relation. See Appendix 4, page 554.

It is convenient to remember that any change of three sizes of this gauge doubles (or halves) the resistance of a wire; a

change of six sizes doubles (or halves) the diameter, and therefore quadruples (or divides by four) the resistance of the wires.

12. Non-conducting or Insulating Materials.—The importance of good conductors, in practical applications of electricity, has been dwelt on in the preceding section. It is, however, equally important to have non-conducting materials in order that electric current may be confined to definite and limited paths. Such materials are commonly called insulators or dielectrics. It is a familiar fact that electric wires are covered with layers of cotton, silk, rubber, and other non-conducting compounds, and are supported on porcelain knobs or in clay tubes. This is done to prevent the current from escaping along a chance side path before the desired terminal point is reached.

Strictly, there is no such thing as a perfect non-conductor. The materials commonly used for this purpose have volume resistivities ranging from 10,000 ohms to 10^{21} ohms between opposite faces of the unit cube. This means that 1 volt impressed across such a unit cube by means of proper metal terminals, would cause a current of from $\frac{1}{10000}$ to $\frac{1}{10^{21}}$ ampere to flow. (See Sections 13 and 14.)

Most insulating substances show a decrease in volume resistivity with increase in temperature. These changes are irregular and sometimes rapid. They are not directly proportional to the changes in temperature. Humidity is of great influence, and tends to lower the volume resistivity in such materials as slate, marble, hard fiber, and materials of the phenolic type such as the material called "bakelite." Very frequently surface leakage is of greater importance than volume conduction, and this surface leakage is largely dependent upon the conductivity of the moisture film upon the surface. In any event, care must be taken to ensure that the effects of surface leakage are either minimized or allowed for.

In work involving high potential differences the property of dielectric strength is of greater importance than volume resistivity. If the potential difference applied between opposite sides of a sheet of dielectric material exceeds a certain critical value, the dielectric will break down, as though under a mechanical stress, and a spark will pass between the terminals.

In case the dielectric is a liquid or a gas, its continuity is immediately restored after the spark has passed. However, in a solid dielectric the path of the spark discharge is a permanent defect, and if enough energy is being supplied from the source, a continuous current will persist, which flows along the arc or bridge of vapor formed by the first spark. "Dielectric strength" is a property of the material which resists this tendency to break down. It is measured in terms of volts or kilovolts required to pierce a given thickness of the material and is sometimes called the "puncture voltage." Values of dielectric strength of air are given in Section 171, page 389. It is a quantity that can not be specified or measured very precisely, because the results vary with (a) the character of the voltage, whether direct or alternating, (b) the distance between the terminals, (c) the time for which the voltage is applied, and (d) the shape of the terminals. The presence of moisture lowers the dielectric strength. Dry air is one of the best of the insulating substances, but its dielectric strength is lower than that of many liquids and solids. The dielectric strength of different specimens of the same insulating material is not directly proportional to the thickness of the specimen.

The properties of most electrical insulating materials are very different when subjected to radio-frequency voltage than when subjected to the low-frequency voltage such as is used on house-lighting mains, or when subjected to direct current. As an example, a piece of insulating material of the phenolic type may withstand 100,000 volts at a frequency of 60 cycles per second, but may deteriorate and become conductive very rapidly when subjected to a voltage of the order of 20,000 volts or less at radio frequencies (say 120,000 cycles per second). In other words, some materials which are suitable for ordinary electrical work, may be entirely unsuitable as radio insulators. Thus slate is extensively used in ordinary electrical work with 60-cycle alternating currents, but is entirely unsuitable for use as an insulating material in radio-frequency circuits. A certain amount of power is lost in every insulating material subjected to an alternating voltage, but the amount of power lost must ordinarily be small if an insulating material is to be satisfactory for most radio uses. Radio-frequency

power loss,^a therefore, becomes of particular importance in selecting insulating material for certain locations about a radio circuit.

In addition to the constant currents which flow through or over insulating substances, due to the "body leakage" and "surface leakage" we find two other currents, which are temporary when a direct voltage is applied, but which it is important not to overlook.

1. The "displacement current" which is discussed later in Section 29. This current appears and becomes negligible in a very short time, not more than a few thousandths of a second.

2. The "absorption current" which persists longer and is observed when an emf. is applied to a plate of a dielectric by means of electrodes as in the case of a condenser. (See Sec. 31.)

At first there is a considerable rush of current but the strength of the current falls off with the time, at first rapidly, then more slowly. It may not become negligible for several hours. It is due to some rearrangement of the molecules of the substance under the stress of the applied emf.

C. Potential Difference, Emf., and Ohm's Law.

13. **The Meaning of Emf.**—In Section 2 it was stated that one of the important electrical quantities is the electromotive force, which is the cause of the electric current. In order to fix in mind the ideas underlying the electric circuit it will be helpful to consider some illustrations drawn from experiences familiar to everyone. Assume that a body of 1 pound weight is raised from the floor to a table, through a height of 3 feet (Fig. 16). Work is done upon the body, and the amount of work done is given by $1 \times 3 = 3$ ft.-lb. The body has acquired "potential energy" by this change in its position. That is, it is capable of falling back to the floor by itself, and in falling back it will, when brought to rest, do an amount of work exactly equal to that which was done in lifting it.

^a For further information regarding dielectric power loss and properties of insulating materials, see Bureau of Standards Circular 74. The Bureau of Standards will issue during 1922 publications giving detailed information regarding the properties of electrical insulating materials of the laminated, phenol-methylene type.

The difference in level between floor and table may be expressed in either of two ways—first, in the ordinary way, by stating directly the vertical distance through which the body was raised; and second, by stating the amount of work required to carry 1 pound of matter from the lower to the higher level. This difference in level, then, defines a very definite difference in condition between the two positions. The higher position, considered as a point in space, has a characteristic which distinguishes it from the lower position, and that is the

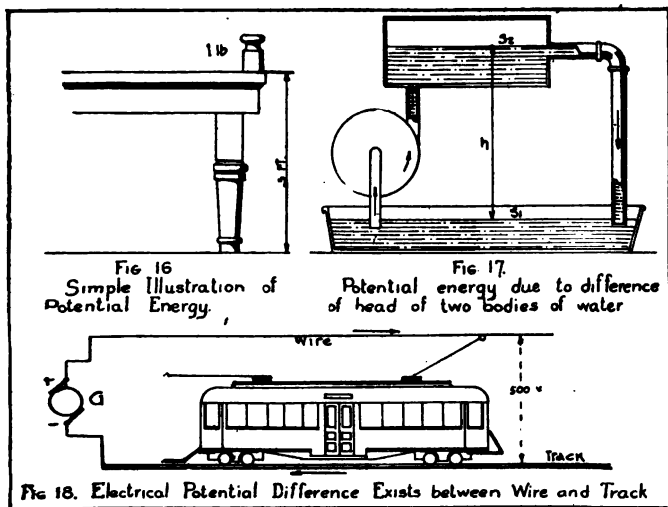

amount of potential energy possessed by a body when placed there. In other words, a body placed at this point is able, by virtue of its position, to do a certain amount of work. If we assume that the body has unit mass, this characteristic is called the **gravitational potential** of the point. The higher position is said to have a higher potential than the lower position, and the difference in potential, measured in terms of work, is a measure of the difference in height.

Following this illustration a little further, we may consider the case of a simple pump, which raises water from a level S_1 to some higher level S_2 (Fig. 17). The water raised by the pump

to the level S_2 possesses potential energy or energy of position. That is, it is able to fall back by itself to the lower level, and in falling back it will do an amount of work exactly equal to that which was done in lifting it. Instead of measuring the difference in level by the height h as before it may be measured in terms of the work done in lifting 1 pound of water from S_1 to S_2 . This difference in level may be called the difference in potential between S_1 and S_2 .

The purpose of the pump is to transform the energy supplied by some steam engine or other prime mover into potential energy, with the corresponding difference in level or pressure head. This establishes what might be called a watermotive force, which causes or tends to cause a flow of water through a return connecting pipe.

Energy may exist in many different forms. The position energy or potential energy of a body has been just described. A moving body has energy of motion or "kinetic" energy. Sound, heat, light, and electricity are all forms of energy; these particular forms of energy are due to "wave motion." (See Sec. 125.) Chemical reactions involve transformations of energy. Every action of everyday life involves a transformation of energy from one form into another. In the case of every transformation of energy from one form into others, it is found that the energy which disappears as one form can be entirely accounted for by the energy which appears in other forms. If the transformation is confined to one body or system of bodies, the total amount of energy possessed by that body or system of bodies is the same before and after the transformation; that is, energy can neither be created nor destroyed. This principle is usually referred to as the "conservation of energy." It should be noted, however, that some forms of energy are far more available for use than others. Thus the potential energy possessed by the water in a reservoir can be easily used, but the energy changed into heat by the friction of water with the sides of a pipe through which it is flowing is usually considered as being "lost," because it is not practically available for use.

Coming now to the electrical case, let us consider that electric current is supplied to the motors of an electric car by means of a generator G , Fig. 18, and two conductors, the trolley wire and

the track. Mechanical energy is being supplied to the generator by some source of power, such as a steam engine, and is being transformed into electrical energy. This transformation results in a flow of current as indicated by the arrows, when a complete circuit is made through the car motors. This condition is described by saying that there is a difference of electric potential between the terminals of the generator, or between the trolley wire and the track. It is the purpose of any electric generator to set up this difference of potential between its terminals, which corresponds to the difference in level of the water in the earlier illustrations. Difference of electric potential is then a difference in electric condition which determines the direction of flow of electricity from one point to another.

Just as height of water column or difference in level may be regarded as establishing a pressure or watermotive force, which in turn causes a flow of water when the valves in the pipe are open, so the electric potential difference may be regarded as establishing an electromotive force which causes a flow of electricity when a conducting path is provided. Electromotive force may be defined as that which causes or tends to cause an electric current.

The unit of electromotive force is the volt. It is that emf. which will cause a current of 1 ampere to flow through a resistance of 1 ohm.

The relation between electromotive force, current, and resistance is called Ohm's law. This law is discussed further in the next section.

The potential difference between two points may be measured in terms of the work done in conveying a unit quantity of electricity from one point to the other. In general

$$E = \frac{W}{Q}$$

where E is in volts, W is in joules, and Q is in coulombs. (See Appendix 2, Units.) In practice, however, it is measured by direct application of an instrument called a "voltmeter." (See Sec. 60.)

The unit of work or energy is the joule. It is the energy expended when a current of one ampere flows through a resistance of one ohm for one second.

Power is the rate at which work is done. The unit of power is the watt, which is the power expended by a current of one ampere flowing through a resistance of one ohm.

Power is sometimes measured in units of horsepower. 1 horsepower equals 746 watts.

14. **Ohm's Law.**—If the pressure upon a pipe line is increased, the flow of water through it in gallons per minute is increased. Ohm found that an increase in the emf. applied to a given conductor caused a strictly proportional increase in the current. Doubling the emf. causes exactly twice as great a current as before, trebling the emf., three times as great a current, etc. This means that for a given conductor the ratio of emf. to current is a constant, and this constant has been called the resistance of the conductor. This important relation is known as Ohm's law, and may be written :

$$\frac{E}{I} = R \quad (9)$$

or, in the alternative forms,

$$E = RI \quad (10)$$

and

$$I = \frac{E}{R} \quad (11)$$

Ohm's law derives its great importance from the fact that it applies to each separate portion of an electric circuit and also to the circuit as a whole.

Case I. Ohm's Law for a Portion of a Circuit.—Assume some part of a complete circuit, R , Fig. 19, which is held at a constant temperature, and has no battery or other source of emf. between the points A and B . If current from an outside source is then caused to flow through R , and correct instruments are used for measuring current and voltage, respectively, the following data may be taken, showing that R has a value of 2 ohms, and that R being constant the current is directly proportional to the voltage.

R Ohms.	E Volts.	I Amperes.
2	1	$\frac{1}{2}$
2	2	1
2	4	2
2	6	3
2	8	4
2	10	5

Suppose two straight lines OY and OX are drawn at right angles to each other, Fig. 20. Divide each line into units and set down the proper numbers at regular intervals along these two lines.* The numbers on the OY axis may be used to represent values of E , and the numbers on the OX axis to represent values of I .

At a point 1 on the E axis draw a light line parallel to the OX axis, and from the point $\frac{1}{2}$ on the OX axis draw a light line parallel to the OY axis. Where these two lines intersect make a dot. Proceed in this way for all the corresponding values of E and I in the table above, and then connect the dots by a line. It is seen that the ratio of E to I is the same for every point that may be taken on the line OP . This means that E and I are connected by a constant factor and I is said to be directly proportional to E . This process is called plotting the relation between the two quantities E and I . Proportionality is indicated by the straightness of the plotted line.

Again, assume that a constant voltage E' is applied across the terminals of R , Fig 19. By some suitable means, change the values of R through a considerable range. The following are some values which careful observation might yield:

E' Volts.	R Ohms.	I Amperes.
24	2	12
24	3	8
24	4	6
24	6	4
24	8	3
24	12	2

Plot the values of R and I on cross-section paper, Fig. 21, and the curve AA is obtained.

Also we may plot reciprocals of R (values of $\frac{1}{R}$ on the axis of abscissas against values of I on the axis of ordinates, Fig. 22. It is now seen that I is proportional directly to the reciprocal of R or, in other words, I is inversely proportional to

* These lines are called axes. OY is called the axis of ordinates and OX is called the axis of abscissas. A distance measured along OY is called an ordinate. A distance measured along OX is called an abscissa.

R. The student should make some experiments of this sort with a resistance box, battery, ammeter, and voltmeter. He should also make a careful record of the readings taken, and then should plot them on cross-section paper, as suggested above. From such a study it will be found that:

(a) For a constant resistance, the current flowing is directly proportional to the voltage.

(b) For a constant voltage the current is inversely proportional to the resistance.

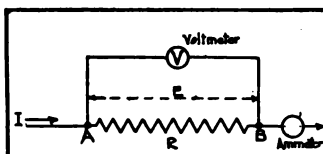

Fig. 19. Simple Circuit for Study of Ohm's Law

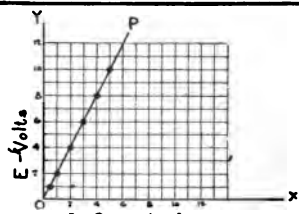

Fig. 20. Current-Voltage Relation in Simple Circuit

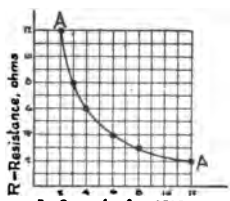

Fig. 21. Current-Resistance Relations in Simple Circuit

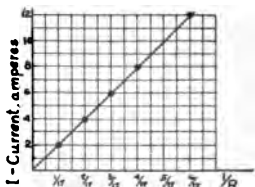

Fig. 22. Current-resistance Relations in Simple Circuit

It is customary to speak of the current flowing "in" a circuit; of the resistance "of" a circuit and of the emf. "between the terminals" of, or "across" any portion of a circuit.

The relation expressed in equation (10) applied to a part of a circuit is used so much practically that the value of E' between *A* and *B* (Fig. 19) has been given various names. It is called (a) the *RI* drop, (b) the potential drop, or (c) the fall of potential in the portion of the circuit between *A* and *B*. If a branch circuit which contains a current-indicating instrument,

such as a voltmeter, (Fig. 19), is connected between these two points, a flow of current is shown to be taking place. The point *A* is at a higher electric potential than *B*, and hence current will flow along the path *A—V—B*.

Case II. Ohm's Law for a Complete Circuit.—In extending this idea to the entire circuit, the total resistance of the circuit must be used. This must include the internal resistance of the generator or battery, or the sum of the resistances of all the generators, if there is more than one. Likewise the voltage must be the resultant or algebraic sum of all the emfs. in the circuit. Ohm's law for the complete circuit may then be written in the form:

$$I = \frac{\pm E_1 \pm E_2 \pm E_3 \pm \dots}{R_1 + R_2 + R_3 + \dots} = \frac{E}{R} \quad (12)$$

In this equation *R* must be the sum of all the resistances in the circuit, including the resistances of all the batteries or generators. In the same way *E* must be the sum of all the emfs., each with its proper sign. For example, there might be a number of cells or batteries in series (see Sec. 24), and one or more of these might be connected into the circuit with the poles reversed. These emfs. would have to be subtracted, hence the negative sign for the terms in the numerator.

Another way of stating this general law when all parts of the circuit are in series is to equate the total emf. impressed on the circuit to the sum of the *RI* drops in every separate portion of the circuit,

$$E = RI = R_1 I + R_2 I + R_3 I + \dots \quad (13)$$

Ohm's law is to be regarded as an experimental truth, which has been established by countless tests for all metals and conducting liquids. For gases at low pressures it does not hold, nor does it apply to certain non-conductors, such as insulating oils, rubber, and paraffin.

15. *Sources of Emf.*—There are a number of ways in which electric energy can be derived from other forms of energy. Each one of these energy transformations sets up a condition which causes current to flow, that is, it produces an emf. The principal sources of emf. will be discussed briefly in the following sections.

Static or Frictional Electricity.—When a piece of hard rubber is brought into close contact with a piece of cat's fur and then separated from it, two things may be noticed :

1. The bodies have both acquired new properties, and are said to be electrified.

2. A force is required to separate the bodies and work is done if they are moved apart.

Both bodies now have the power of attracting light bits of chaff or tissue paper. The rubber is said to have a negative charge and the fur a positive charge. These charges exist in equal amounts and taken together they neutralize each other. An uncharged body is said to be neutral. When these charges are at rest upon conductors they are called electrostatic charges. Electric charges may be communicated to small light bodies, like pith balls, and if these are suspended from silk threads the effects and properties of the charges may be studied in terms of the motions and behavior of the pith balls. Two pith balls charged oppositely are found to attract each other, and two with like charges to repel each other. The force between them in either case is proportional to the product of the charges and inversely proportional to the square of the distance between them. The force is also inversely proportional to the value of the dielectric constant of the material between the charges, if the charges and the distance between them remain constant. (See Sec. 31.)

Electrostatic forces are ordinarily very small. There are many substances other than the two mentioned which become charged by friction with other materials. As glass is such a substance, the glass face of an instrument should never be wiped with a cloth just previous to use, as it thus may accidentally become charged to such an extent as to affect the light needle below it and cause a considerable error in its reading. In case this has happened, breathing upon the glass or wiping it with a moist cloth will remove the charge.

If two conducting bodies carrying opposite charges are connected by a conductor, a momentary flow of current takes place and the two bodies come to the same electrical condition. If the original charges were equal, both bodies are discharged. The flow of current continues for only a moment because there is no source of electricity, such as a battery, maintaining a constant difference of potential between the bodies.

Electrostatic experiments can be best performed on a cold day when the air is dry.⁴

Batteries.—When two plates of different substances, such as two metals, or a metal and carbon, are placed in a water solution of certain salts or acids, there is found to be a difference of potential between them. If the exposed parts of the plates, called the electrodes, are connected by a conductor, current will flow. The following list contains the names of some of the substances which are used as battery electrodes. The order of the arrangement is such that when any two are taken, current will flow through the wire to the one appearing higher in the list from the one farther down. In selecting materials to act as electrodes in batteries, the farther apart the metals are in this list the greater is the electromotive force of the cell. The order shown is not absolutely invariable, but in some cases may depend on the electrolyte used.

Zinc.

Cadmium.

Iron.

Nickel.

Lead.

Tin.

Copper.

Mercury.

Silver.

Platinum.

Carbon.

The salt and acid solutions used are conductors of electricity, but their conductivity is not so high as that of the metals. They are called "electrolytes."⁵ Some examples are solutions

⁴For further study of electrostatic phenomena the student is referred to Crew, *General Physics*, Chap. IX; Franklin and MacNutt, *General Physics*, Chap. XV; Starling, *Electricity and Magnetism*, Chap. V; S. P. Thompson, *Elementary Lessons in Electricity and Magnetism*, Index; W. H. Timble, *Elements of Electricity*, Chap. XI; Watson, *A Textbook of Physics*, pp. 633-680.

⁵Not only do electrolytes conduct electricity but when a current is passed through them the molecules of the acid or of the salt are decomposed or broken up. The metallic part of the molecule, or its hydrogen, always travels toward the terminal from which the current leaves the solution, and is deposited there. This is the basis of electroplating processes, and it is in terms of such a process that the ampere was defined. (See Sec. 5.)

of sulphuric acid, copper sulphate, potassium chloride, and sodium chloride or common salt. Ordinary water from the service pipes contains enough dissolved substance so that it conducts electricity to a slight extent. With any two materials of the table dipped in one of the solutions mentioned, there will be produced an emf. and a resulting flow of current. The farther apart the selected materials stand in the list the greater will be the effect produced.

This arrangement for producing a current is called a "voltaic cell." Several types of this cell will be described in sections 17 to 19.

Thermoelectricity.—Assume pieces of two different metals CJ and $C'J$, Fig. 23, soldered together at the point J . The other

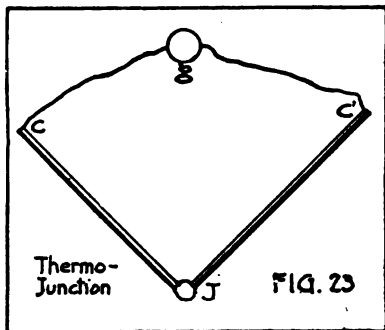

ends are connected by a copper wire through the galvanometer g . If the point of contact, or junction J , is heated to a temperature above that of C and C' , there will be a flow of current through the galvanometer. This is commonly explained by saying that at the junction J , heat energy is transformed into electrical energy, and this

junction is regarded as the seat of an emf. In case the temperature of J is lower than that of CC' , the direction of the current will be reversed. In the following table some common metals are so arranged that when any two of them are chosen for the circuit, current flows across the heated junction from any one to one standing lower in the list.

Bismuth.
Platinum.
Copper.
Lead.
Silver.
Antimony.

The presence at the junction of an intermediate metal or alloy like solder, will not affect the value of the emf. developed,

because whatever effect is developed at one point of contact with the solder, is annulled at the other. Of the pure metals, a thermocouple made of bismuth and antimony gives the greatest thermoelectromotive force for a given difference in temperature. However, certain alloys are frequently used for one or both of the materials. The purity and physical state of these materials is an important factor in securing uniformity of results. A thermoelement or thermocouple may be calibrated with a given galvanometer; that is, a curve may be plotted coördinating microvolts and temperatures. It then becomes a valuable device for measuring temperatures, especially where other forms of thermometer can not be used. For the range from liquid air temperatures, -190° C., to 200° or 300° C., copper-advance* or iron-advance thermocouples are often used. For high temperatures, upward of $1,700^{\circ}$ C., a thermocouple of platinum and a platinum-rhodium alloy is used.

Thermocouples find application in radio measurements in hot-wire ammeters. See Section 59, page 136.

Induced Emf.—Electromotive force may be set up in a circuit by the expenditure of mechanical work in pushing wire conductors across magnetic lines of force. See Section 45, page 108. Also when electric current in any circuit is caused to vary, an emf. which is the result of this variation arises in any nearby circuit. The principles which apply to these cases are fully stated in Sections 45 and 47, pages 108, 112. The development of machinery based upon these principles is the subject of Chapter 2.

The RI Drop.—When for some purpose a voltage is desired which is less than that of the available battery or generator, or one which can be readily adjusted to any desired value, it is often convenient to take advantage of the *RI* drop across a given resistance, as described in Section 14, and to arrange a circuit as in Fig. 24. The current from the battery which flows through the resistance *ab* can be adjusted to any desired value by properly choosing the value of *ab*.

*Advance is a trade name for an alloy of copper and nickel. This material is widely used for resistance coils and rheostats. Its resistivity is high and its temperature coefficient is practically negligible. It has, however, a large thermoelectromotive force against copper or brass.

Since the voltage drop along ab is directly proportional to the resistance r , any desired fraction, $\frac{1}{n}E'$ may be obtained by setting the contact c at such a point that the resistance ac is equal to $\frac{1}{n}r$. This follows from equation (10) where it is seen that the emf. across any resistance is directly proportional to that resistance so long as the current remains constant. This is nearly enough true for practical purposes if it be assumed that the resistance of ab is relatively large as compared to the internal resistance of the battery. The resistance ab may be in the form of a resistance box with a travelling contact at c , or it may be a uniform homogeneous wire, with an adjustable contact point at c . Such a device for subdividing a voltage is called a "voltage divider," and has often been erroneously called a potentiometer.

Standard of Electromotive Force.—The emfs. due to the ordinary battery cells are usually between 1 and 2 volts. A certain type of cell has been selected by international agreement as a standard of emf. The type now most used is called the Weston standard cell, because it was first suggested by Weston. It is also called the "cadmium cell," because cadmium is used as the negative electrode. This cell is made from carefully selected chemicals of great purity, and when used under controlled temperature conditions its voltage can be depended upon to remain constant within a few parts in 100,000. At 20° C. (68° F.) its emf. is 1.0183. The value of the volt is maintained by reference to similar cells kept in the national standardizing laboratories.

16. Internal Voltage Drop and Line Drop.—Reference to equation (13), page 51, will show that the voltage or emf. of the generator, whether battery or dynamo, must always be thought of as being expended in three parts, as follows:

1. That part which sends current through the generator itself, called the "internal drop."
2. That part which sends current through the line, called the "line drop."
3. That part which sends current through the terminal apparatus, such as lamps, motors, or heating coils. This is the useful part of the emf., the first two being wasted so far as useful work is concerned.

This division of the generated emf. is illustrated in Fig. 25. Since part 3 is the part which is applied in the external circuit, it is clear that the generator must always supply a higher voltage than is needed at the terminals in order to take care of parts 1 and 2. The above facts may be again stated in the form
 Total emf. = drop in generator + drop in line + useful drop in load.

Voltage Drop in Battery or Generator.—Assume a circuit as shown in Fig. 26. As long as the key K is open, the cell is not sending current through the circuit R . A high resistance volt-

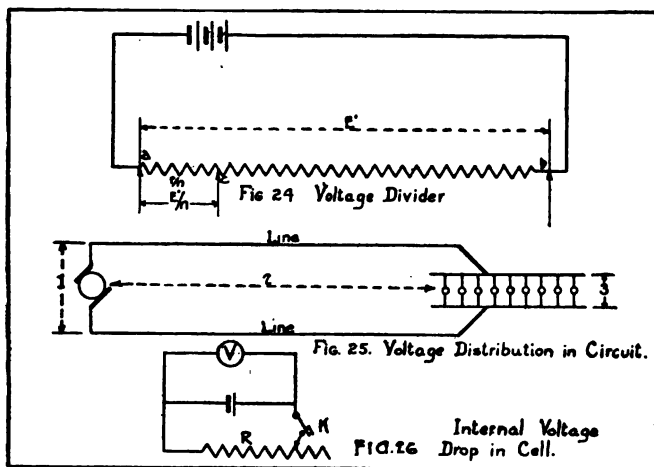

meter V gives a reading E , which is the full open circuit voltage of the cell. The voltmeter current is so small that the cell may be regarded as supplying no current through it. If, without removing the voltmeter, the key K is closed, a current I flows through the external circuit R , and the voltmeter reading is seen to drop back to some value E' which is less than E . As R is made smaller the value of E' continues to decrease, until when $R=0$, that is, when the poles of the cell are short-circuited, the voltmeter shows no deflection whatever. The rate of change of the current, I , is less than the rate of change of the external resistance, R . The voltmeter indicates at any instant the

then existing value of the voltage at the cell terminals and this may vary from the open circuit voltage or emf. E , to zero, depending upon the external circuit condition. For any value of R the current flowing is given by the equation

$$I = \frac{E}{r+R} \quad (14)$$

where r is the internal resistance of the cell, or

$$E = RI + rI \quad (15)$$

Thus the emf. E is equal to the sum of the potential drop in the cell and the RI drop in the external circuit. Denoting RI by E' , we may write equation (15) in the form

$$E' = E - rI \quad (16)$$

The quantity E' is called the "terminal potential difference," or the "terminal voltage" of the cell, and it is always less than the full emf. by the RI drop in the cell itself. It may be defined as the useful part of the emf., or that part which is available for sending current through the external circuit.

The emf. E is determined once for all by the choice of materials used in the cell, and it can not be in any way altered after the cell is once chosen. The terminal voltage, however, can be varied through all possible values from E to zero. Anything that may be done to lessen the internal resistance of the battery, such as putting several cells in parallel (see Sec. 24), will lower the RI drop and correspondingly increase the terminal voltage E' . After the RI drop has been subtracted from the emf. E the balance is the terminal voltage, or that part of the emf. which is available for work in the external circuit. The current drawn from the battery must be regarded as flowing through the entire circuit. As this value of I increases, the internal voltage drop in the battery increases, and a correspondingly smaller fraction of the total emf. is available for the external circuit.

What has been said here of a cell is equally true of any other form of generator.

Voltage Drop in the Line.—Suppose that a d. c. generator, capable of supplying 118 volts at the outgoing wires of a power house, is furnishing current to a distant building for lighting

lamps which require 110 volts. Suppose that the line resistance is 0.16 ohm and that the lamps require 50 amperes of current. There is then a line drop of 8 volts, and the available voltage at the generator is just right to operate the lamps at their rated voltage. Suppose, however, that other apparatus near the lamps, say, the motor of an electric elevator, is put in operation, and that this requires 70 amperes of current. The line drop is then increased by 11.2 volts, or 19.2 volts in all, and the voltage available at the distant end of the line has fallen to 98.8 volts. This is not enough to maintain the lamps at full brightness and they are dimmed perceptibly every time the elevator is operated. To correct this difficulty, a new line of lower resistance must replace the old one; that is, the line drop must be decreased, so that for the maximum current demand the lamps will not fall below 110 volts.⁷

Another example of the line drop is seen in the dimming of the lights of a trolley car when the car is starting. The resistance of the trolley wire is kept low by using a large cross section of copper, and the track resistance is kept as low as possible by careful bonding at the rail joints. However, a few defective joints raise the track resistance and increase the line drop to such a degree that the necessary lamp voltage can not be maintained when the car starts.

D. Electric Batteries.

17. General Description.—An electric battery consists of two or more connected cells which convert chemical energy into electrical energy. The cell is the unit part of the battery, but the term "battery" is sometimes incorrectly used to mean one cell. The essential parts of any cell are two dissimilar electrodes, such as zinc and carbon, immersed in an electrolyte in a suitable jar or container. The electrolyte is a solution of certain acids, hydroxides, or salts in water, according to the type of cell.

⁷ *Problem.*—Assuming that the distance from power house to lamps is one-eighth mile, calculate the resistance of the line which is necessary to maintain the lamp voltage at 110 volts while the elevator is operating. Find also the size of copper wire which should be used for this line.

There are a number of different kinds of cells in common use. These are classified as primary or secondary cells. The most familiar primary cell is the dry cell. Secondary cells are storage cells or accumulators. The distinction between primary and secondary cells is based on the character of the chemical reactions which occur in them. Primary cells can not be charged by an electric current. When they are exhausted they are discarded or provided with new electrodes and new electrolyte when this is possible. Storage cells, on the other hand, convert chemical energy into electric energy by reactions which are essentially reversible; that is, they may be charged by an electric current passing through them in the opposite direction to that of their discharge. During this process electric energy is transformed into chemical energy which may be made use of at a later time as electric energy. The electricity is not stored as electricity by these cells.

The capacity of a battery may be specified as the quantity of electricity which it will deliver under given operating conditions. It depends, among other things, on the temperature, current delivered, lowest voltage permissible at end of service, and the nature of the service required. Thus the capacity of a storage battery is usually given in ampere-hours (see sec. 5) under specified operating conditions.

Cells may be connected together to form batteries by connecting them in "series" or in "parallel." (See Sec. 24.) When cells are connected in series, the positive terminal of one cell is connected to the negative terminal of the next cell and so on to the end of the group. The voltage of such a group is the sum of the voltages of the individual cells. The ampere-hour capacity of such a battery is no more than the ampere-hour capacity of a single cell. Cells are connected in parallel when all the positive terminals are connected and all the negative terminals connected together. The voltage of such a group is no more than that of a single cell, but the ampere-hour capacity of such a battery is the sum of the capacities of all the cells. Sometimes groups of cells are connected in series and the groups are connected in parallel making a series-parallel arrangement, but the most familiar grouping is the simple series connection. Cells to be connected in parallel should be of the same type and voltage.

18. **Simple Primary Cell.**—The simplest form of primary cell is made of a strip of copper and a strip of zinc immersed in water acidulated with sulphuric acid. Such a cell is illustrated in Fig. 27. If the zinc is sufficiently pure to be free from local action (see below), no visible action will take place until the zinc and copper are connected by a wire. The strips are, however, at different potentials with respect to each other and when they are connected by a wire a current of electricity will flow in the wire. As this action progresses, the strip of zinc will pass into solution and bubbles of gas will appear on the copper strip. The electric current flows from copper strip through the wire to the zinc strip and from the zinc strip through the liquid to the copper. The current is transported through the liquid, which is called the "electrolyte," by particles of molecular size that carry electric charges. These particles are called "ions."

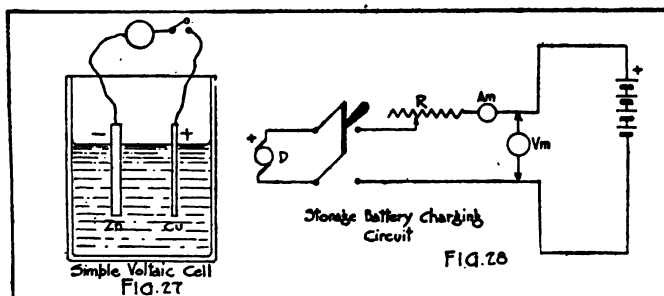

The external circuit is connected to the cell at its terminals or "poles." The copper terminal is usually called the positive terminal and may be indicated by a + sign. Similarly the zinc is the negative terminal. When a voltmeter is used to measure the voltage of a cell or to determine its polarity, the voltmeter terminal which is marked + is always to be connected to the + terminal of the cell. To avoid an ambiguity that sometimes arises in the designation of the positive and negative electrodes of the cell, the exact terms "cathode" and "anode" may be used. The cathode is the electrode toward which the ions with positive charges move while the ions with negative charges move to the anode. The cathode terminal is the one which we have defined above as the positive terminal. The anode terminal

similarly is the negative terminal. This is the generally accepted convention as to positive and negative terminals. When a cell or battery is represented in the diagram of a circuit, it is customary to represent each positive terminal of the cell by a long thin line and each negative terminal by a short thick line.

The simple cell which has been described above is subject to limitations in actual use, and it is therefore desirable to employ other primary cells that are better adapted for the service required of them. These will be described in the next section. It is convenient, however, to describe here the difficulties which arise in using the simple zinc-copper cell to illustrate the meaning of the terms "local action," "polarization," and "internal resistance," which are frequently used.

Local action is the wasting of the zinc when the cell is not in use. If zinc of absolute purity could be used, it would pass into solution only when the cell was furnishing current to the outside circuit. Zinc generally contains impurities, and each little particle of foreign matter acts with adjoining zinc particles to make a tiny cell on the surface of the zinc. The result is that the zinc is continually passing into solution at many places with the evolution of bubbles of a gas, which is hydrogen. Each of these little parasitic cells gives rise to a current of electricity, useless for practical purposes, in the immediate vicinity of the foreign particle. Hence the wastage of the zinc is commonly called local action. It was discovered many years ago that if the surface of the zinc is amalgamated with mercury that the local action is greatly decreased. A simple method of amalgamating the zinc is to dip the zinc in dilute sulphuric acid and rub some mercury on the zinc with a brush.

Polarization is caused by the film of gas bubbles deposited on the copper strip when the cell is in operation. This gas is hydrogen, and the amount of it that is produced is proportional to the current that flows and to the time. This layer of hydrogen bubbles produces a voltage that opposes the voltage of the cell and it diminishes the surfaces of contact between the copper and the electrolyte. This increases the resistance. For two reasons, therefore, this layer of gas bubbles diminishes the useful output of the cell. The practical result is that the voltage and the current which the cell can furnish are con-

siderably reduced within a short time after the circuit is closed. Polarization may be prevented or in a large measure reduced by "depolarizers." A variety of chemical substances are used as depolarizers. Some of them are solids, some liquids, and some gases. In addition, mechanical means, such as shaking the cell, may also accomplish depolarization. The formation of hydrogen bubbles on the cathode is the most familiar form of polarization, but there are also other causes for polarization that will not be discussed here.

The *internal resistance* of any cell is dependent on the kind and condition of the cell. The resistance of the cell or battery is properly to be considered as part of the resistance of the entire circuit—that is, the resistance of any circuit containing a battery is the sum of the resistance of the external circuit and the resistance of the battery. For practical purposes the internal resistance of a primary battery may be measured by determining the change in voltage at the terminals of the battery when a known change is made in the current which it discharges. If the voltage at the terminals of the battery is E_1 when the current I_1 is flowing and E_2 when current I_2 is flowing, then by Ohm's law the resistance R will be

$$R = \frac{E_1 - E_2}{I_2 - I_1} \quad (17)$$

R is not strictly a constant quantity, however. The internal resistance of a storage battery is very small and can not conveniently be measured by the above method. Lead storage batteries in particular have very low internal resistance and for this reason can deliver very large currents. It is dangerous to short-circuit a storage battery, since excessively large currents will be produced, which may cause fusing of the terminals and other damage. Since lead storage cells have particularly low internal resistance, it is especially dangerous to short-circuit a lead battery because a very large current may flow.

19. **Types of Primary Cells.**—Although a potential difference may be observed whenever two dissimilar conductors are immersed in any electrolyte, certain combinations give more voltage, more output, or possess other desirable features, so that they have become the practical primary cells in use at the

present time. The desirable qualities of a primary cell are large voltage and large current capacity, low internal resistance, freedom from local action and noxious fumes. Dry cells possess these characteristics and in addition are readily portable, but they are subject to some polarization. Primary batteries are a convenient source of electrical energy. In isolated localities they may be indispensable, but they are expensive to operate if any considerable amount of energy is required, as for lighting or running a motor.

The emf. of a cell depends upon the materials chosen for the electrodes and to some extent on the electrolyte, but not on the size or arrangement of the electrodes.

The *dry cell* is the commonest form of primary cell at the present time. Several hundred million are made annually. Small dry cells are used in flashlight batteries. The plate circuit of an electron tube used for receiving radio signals is usually supplied with voltages from 20 to 60 volts, but it is necessary to supply only a small current. Small dry cells are sometimes used for this purpose, and are usually manufactured in units of 15 cells in a single container, each cell being $\frac{5}{8}$ by $1\frac{1}{2}$ inches. The most familiar dry cell is $2\frac{1}{2}$ inches in diameter and 6 inches high and weighs about 2 pounds. This is frequently called the No. 6 size. A larger size, the No. 8, which is $3\frac{1}{2}$ by 8 inches, is less commonly made and weighs $5\frac{1}{2}$ pounds. There are other sizes also, which are described in Circular 79 of the Bureau of Standards, entitled "Electrical Characteristics and Testing of Dry Cells."

Dry cells are so called because the electrolyte is held in an absorbent material which permits the use of the cell in any position. The cell is, however, not dry. Ordinarily the zinc serves as the container for the cell and as one electrode. The electrolyte consists of a water solution of ammonium chloride (sal ammoniac) and zinc chloride. This electrolyte is held partly by an absorbent material that lines the zinc container and partly by the black mixture of ground carbon and manganese dioxide which is the other electrode. This mixture is bulky and occupies most of the interior of the cell. The electrical connection from the mixture of carbon and manganese to the positive terminal of the cell is made by means of a carbon rod embedded in the center. The manganese dioxide is the

depolarizer. During the discharge of the cell this is reduced to a lower state of oxidation.

The most familiar method of construction for the larger sizes made in this country is the paper-lined method. Before the cell is filled with the depolarizing mixture a lining of pulpboard is placed in the cell. This serves a double purpose. It is an absorbent for the electrolyte and it separates the manganese-dioxide mixture from the zinc. If the manganese dioxide were in direct contact with the zinc, an internal short circuit would result. Bag-type cells on the other hand are so called from the fact that the depolarizing mixture is contained in a cloth bag which is surrounded by the electrolyte in the form of a paste or jelly. This latter method of construction is generally used in the smaller cells for flashlight batteries and is commonly used in the European cells of all sizes.

The open-circuit voltage of the dry cell is about 1.5 volts. Its maximum or short-circuit current depends on the size and kind of cell. No. 6 cells of American manufacture for ignition purposes will ordinarily give 25 to 35 amperes on short circuit, telephone cells and bag-type cells from 15 to 25 amperes. A test of the short-circuit current is of value only in showing the uniformity of cells. In no case should dry cells be used where such excessive currents are required. Dry cells are intended primarily for intermittent use, but may be used continuously for small currents. The current which can be supplied economically by the No. 6 size cell depends upon the duration of its use. For one-half of one hour per day, 1 ampere is not excessive, four to eight hours per day, one-fourth of an ampere, and for continuous service 0.1 ampere are reasonable currents.

Dry cells deteriorate even when not in use. In general, the smaller sizes deteriorate faster than the larger sizes. This deterioration can be considerably retarded by keeping the cells and batteries in a cool, dry place. Dry cells should not be allowed to freeze.

Another form of dry cell is the silver-chloride cell, which is made in small sizes and used in apparatus in which a cell is required for intermittent service over long periods of time. The depolarizer in this cell is silver chloride. The positive electrode is silver and the negative electrode zinc. The open-circuit voltage is 1.0 volt and the maximum current which it

can give is from 0.5 to 1.0 ampere. These cells do not deteriorate ordinarily when standing idle. The ampere-hour capacity of this cell is small.

Closed circuit cells are intended for use where a continuous flow of current is desired. Such cells must be free from polarization and must possess large ampere-hour capacity. Railway signaling and ordinary telegraphy with wires are typical examples of this type of service. The gravity cell has been extensively used for these purposes. It consists of a copper electrode in a saturated solution of copper sulphate, above which is a lighter solution of zinc sulphate surrounding a zinc electrode. The voltage of this cell is about 1 volt, but it has considerable internal resistance. Caustic-soda cells are now more commonly used for this purpose, since they have a much lower internal resistance and require less attention. Zinc plates form one electrode, the other being copper and copper oxide, which serves as the depolarizer. The electrolyte generally used is a 20 per cent solution of caustic soda (sodium hydroxide). The working voltage of this battery is from 0.6 to 1.0 volt, depending upon the rate of current discharge and the length of time that it has been in service. When these cells are exhausted, they may be renewed by preparing a new electrolyte and inserting new elements, which are usually assembled as a single unit. This battery is a development of the Lalande battery.

Leclanche cells have elements similar to the ordinary dry cells, but are frequently referred to as "wet" cells in contrast to the dry cell. The electrolyte is a solution of sal ammoniac contained in a glass jar. They are made in various forms and are intended for bell ringing and other light and intermittent service. A cheaper form, commonly called the carbon-cylinder battery, is also used for similar purposes. This consists of a zinc rod and cylinder of carbon without depolarizer, in the solution of sal ammoniac. The voltage of such a cell is about 1.4 volts and it can yield several amperes momentarily. It polarizes rapidly, but the gas collecting on the carbon cylinder has opportunity to diffuse during periods of idleness. Other forms of primary cells are of less importance and will not be discussed here.

For bell ringing and similar work in which alternating current can be used, batteries are sometimes replaced by small transformers rated at only a few watts, which are connected to the

a. c. electric-light supply and deliver about 10 volts at their secondary terminals. (See Sec. 58.)

20. **Storage Cells.**—Storage cells differ from the primary cells described above, since they may be charged and discharged many times without any renewal of the electrodes or electrolyte. When a storage cell is discharged, the current flows from the positive terminal to the external circuit and back to the cell through the negative terminal, as in the case of primary cells, which were described above. It is important to be able to distinguish the positive terminal of the storage battery, particularly for charging purposes. It is frequently marked with a plus sign, or the letters POS, or a red spot of paint, or a red bushing around the terminal post. When the polarity of the battery can not be determined by any of these means, a voltmeter should be used to determine the polarity.

The open-circuit voltage of a storage cell depends entirely upon its chemical composition and in no way upon the size or number of the plates. The capacity of a storage cell is usually expressed in terms of ampere-hours at a certain rate of discharge at normal temperature. If a cell is described as 100 ampere-hours at the 5-hour rate, it means that the battery will deliver 20 amperes for 5 hours, the product of the hours and the amperes being 100 ampere-hours. If the battery is discharged more rapidly than this, the capacity will be proportionately less, and at lower rates of discharge it will be somewhat greater.

Storage cells are usually connected in series as described above. The capacity of such a battery in ampere-hours is the same as that of a single cell, but the voltage is equal to the sum of the voltages of the individual cells. It is not desirable under ordinary circumstances to connect storage cells in parallel.

There are two general types of storage batteries of practical importance. These are the lead-plate batteries, containing acid electrolyte, and the nickel-iron batteries, containing alkaline electrolyte.

Lead batteries consist of lead plates immersed in a solution of sulphuric acid. The jar or container for portable batteries of this type is usually of a hard-rubber compound, but larger batteries, which are used in a fixed position, are generally contained in glass or lead-lined tanks. The lead plates for

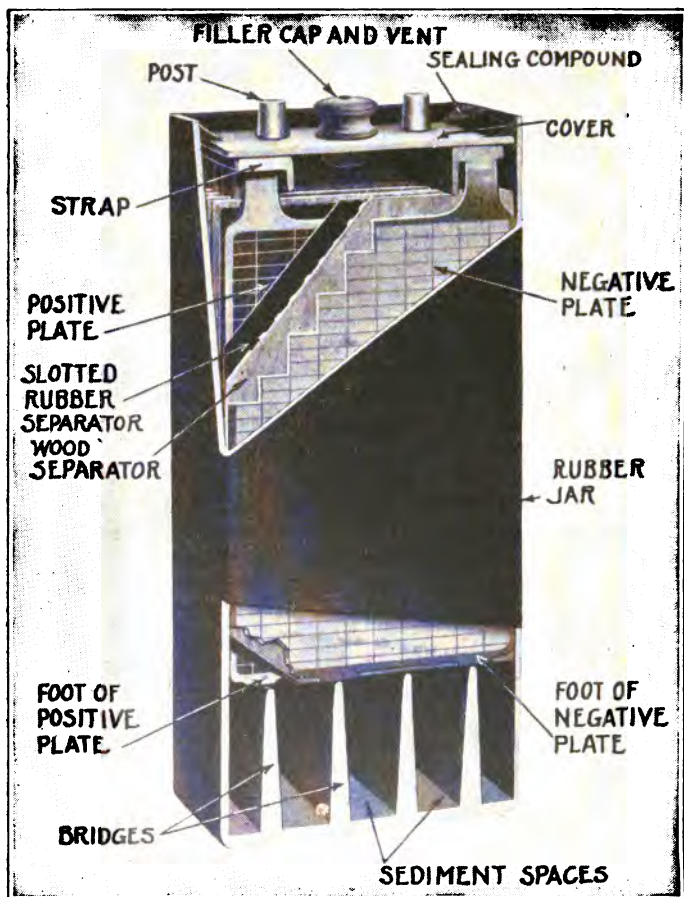

FIG. 29.—Storage cell. Lead plate-acid electrolyte type.

the portable types of batteries are usually of the "pasted" variety. These consist of a flat frame or grid, which is made of an alloy of lead and antimony, into which the active materials in the form of a paste made from lead oxides are pressed. The structure of the grid is such as to hold the active materials in place after they have cemented into a solid mass. Plates which are made in this way are then "formed." This consists of a prolonged charge from a source of direct current, which oxidizes the plates intended for positives until the active material of the plate is transformed into lead peroxide, which is the familiar brown material of the positive plate. The negative plates are reduced from the oxide condition of the paste to sponge lead, which is of a dull gray color. In making a cell, the required number of positive plates are welded to a connecting strap, forming the positive group. Similarly, the negative plates are made to form another group which will interleave with the plates of the positive group. There is always one more negative than positive plate in the cell. To prevent a metallic connection within the cell, separators are used between the positive and negative plates. These generally consist of thin sheets of wood. In addition to the wood separators, perforated or slotted rubber separators are sometimes used. A cell of the lead plate type, in which both kinds of separators are used, is shown in Fig. 29, page 68. The complete cells are joined together to form a battery by connectors which are made of an alloy of lead and antimony. These connectors are welded to the terminal posts of the cells, but this process is usually referred to as "lead burning."

The nickel-iron batteries consist of plates that are made of steel grids. Positive plates have round tubes which contain a nickel oxide as the active material. The negative plates have thin rectangular pockets containing iron in a finely divided state. The electrolyte for these batteries is a solution of potassium hydroxide, to which certain other substances are added. The cells are contained in a steel can, which is electrically welded together. It is not practicable, therefore, to make repairs to these cells in the field. Fig. 30, page 71, shows the parts of a nickel-iron cell. The cells are connected together to form a battery by means of copper connectors that

are nickel plated. These are attached to lugs having a taper which fits the terminal posts of the cell. These connectors are bolted and are not burned on, as in the case of the lead cells. Since the containers of these cells are electrical conductors, it is necessary that the cells be insulated from one another. This is accomplished by a special tray which holds the cells in place with space between each of the cells by means of suspension bosses on the sides of the cells.

21. **Electrical Characteristics of Storage Cells.**—The ampere-hour capacity of a storage cell is the number of ampere-hours which can be delivered by the cell under specified conditions as to temperature, rate of discharge (i. e., current delivered), and final voltage at end of discharge. Thus the manufacturer may state that the capacity of a given storage cell is 100 ampere-hours at 25° C., when delivering a normal discharge current of 20 amperes to a final voltage of 1.75 volts at end of discharge.

Cells of the lead-acid type.—Cells of the lead-acid type have an open-circuit voltage of approximately 2 volts. The open-circuit voltage, however, does not indicate the state of charge of the battery. When a lead cell is being discharged at its normal rate, usually given by the manufacturer on the name plate, the voltage at its terminals gradually falls from approximately the open-circuit value to about 1.75 volts, at which point practically the complete capacity of the battery has been delivered. It is not desirable to continue the discharge beyond this point, except when the cell is delivering current at much more than the normal rate; for example, at 10 times the normal rate of discharge it is permissible to continue the discharge until the voltage of the cell has fallen to about 1.40 volts per cell. The average voltage which the cell can maintain during discharge varies with the rate of discharge and the construction of the cell. The average voltage will be about 1.95 volts when discharging at the normal rate and 1.75 when discharging at five times the normal rate. As the cell discharges, the specific gravity of the electrolyte decreases. This is because lead sulphate forms on both the positive and the negative plates in the process of discharging. It is possible, therefore, to estimate the state of charge of a lead-acid cell by the specific gravity of its electrolyte. This may be determined with a syringe hydrometer. The hydrometer is a float inclosed in a glass tube having a

rubber bulb at its upper end, which may be used to draw the electrolyte into the tube. The specific gravity of the electrolyte is ascertained by the position in which the hydrometer floats. For many types of portable batteries the cell is considered discharged when the specific gravity has fallen to 1.140.

The nickel-iron cells have an open-circuit voltage which varies from 1.45 to 1.52 volts. When these cells are discharging, the

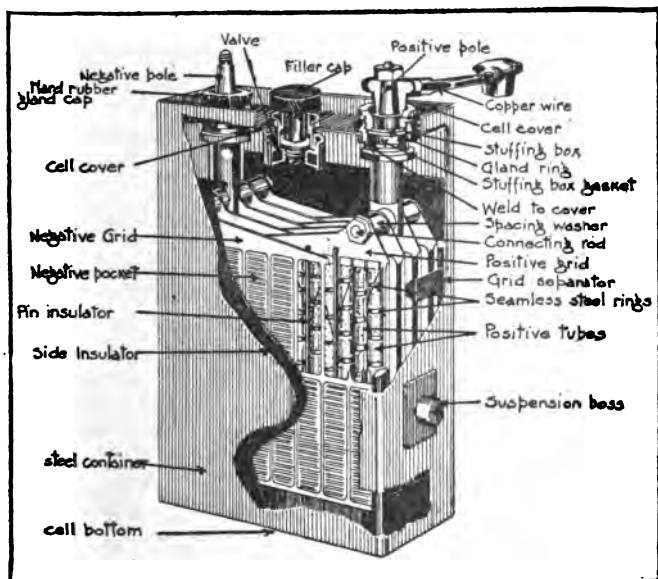

FIG. 30.—Storage cell of nickel-iron type having alkaline electrolyte.

voltage falls gradually from approximately the open-circuit value to a final voltage which may be taken as 0.9 volt per cell at the normal rate, or as 0.8 volt at twice the normal rate. The average voltages during discharge of the cells are approximately 1.14 volts per cell at the normal rate, or 1.05 at twice the normal rate. The state of charge of the nickel-iron cells can not be ascertained by the specific gravity of the electrolyte, as in the case of the lead batteries.

When storage cells are discharging, the voltage falls gradually. The rate at which it falls depends on the current that is being drawn from the battery, its state of charge, and the kind of cell. The voltage of the nickel-iron cells falls more rapidly than that of the lead cells under similar conditions. For this reason when cells are used to supply, for example, the current to the filament of an electron tube (see Chap. 6), it is necessary to adjust the rheostat in the filament circuit occasionally. The lead cells are better suited to this purpose than the nickel-iron cells. If the latter are used, it will be necessary to readjust the current approximately every half hour under ordinary operating conditions.

22. Charging and Maintenance of Storage Cells.—Direct current alone can be used for charging storage cells or batteries of either type. If alternating-current power only is available, it must be converted into direct current by means of a motor-generator set, or synchronous converter, or some type of rectifier. Mercury-vapor rectifiers or a "tungar" rectifier are often used. The charging is generally done by the constant-current method; that is, the charging current through the battery is held constant by an adjustable resistance at the normal rate specified on the name plate of the battery during the period of charge. The positive terminal of the charging circuit must be connected with the positive terminal of the cell or battery. A failure to observe this rule may result in injury to the battery. A simple charging circuit is shown in Fig. 28. During the period of charge the voltage at the terminals of the battery gradually rises, so that it is necessary to decrease the resistance which is in the circuit to maintain the current at a constant value. The amount of current which flows through the battery is dependent upon the difference between the voltage of the battery and that of the charging circuit. It is necessary, therefore, that the charging circuit should have sufficient voltage to allow 2.5 volts for each lead cell or 1.7 volts for each nickel-iron cell in the battery. The period of charging ordinarily consumes from five to eight hours. During the later part of the charging period lead-acid batteries begin to gas freely, and it is usually necessary to decrease the charging rate to prevent excessive gassing and a rise in temperature. The finishing rate of charge, as this reduced current is called, is

approximately 40 per cent of the normal charging rate. The nickel-iron batteries, on the other hand, gas throughout the entire period of charge and no decrease in the rate of charge is made. These batteries are completely charged under ordinary circumstances in seven hours. It is not advisable to charge nickel-iron batteries at less than the normal rate. In charging or discharging either type the temperature should not be allowed to exceed 110° F.

The gases which are liberated during the charging period are oxygen and hydrogen. These gases form an explosive mixture, and it is dangerous to bring any open flame into the room where batteries are being charged. Good ventilation should be provided. If the connecting wires to a battery under charge accidentally come into contact for an instant, the spark so formed may cause an explosion of the hydrogen and oxygen present. The gassing results in a loss of water in the cells, which must be replaced. For either type of battery it is desirable that this should be distilled water. When it is impossible to obtain distilled water, ordinary drinking water may in most cases be used. Choking fumes sometimes observed when batteries are on charge are due to electrolyte sprayed into the atmosphere by the bursting bubbles of gas.

It is also possible to charge these batteries by what is called the "constant potential" or "tapering charge" method. For this purpose, the voltage at the terminals of the battery is maintained at a constant value throughout the period of the charge. The initial charging current may be very large, but it decreases automatically as the charging of the battery progresses. At the end of the charging period the current will have fallen to a value considerably below that of the normal charging rate. The time for a complete charge by this method is approximately the same as when the cells are charged by constant current. The advantages of the constant potential method, however, are that a large percentage of the charge can be put into the battery during a short time and that the regulation of the charging current is automatic and may be adjusted to avoid most of the gassing of lead cells. For these the charging voltage should be approximately 2.3 volts per cell at the terminals of the cell. For the nickel-iron cells 1.7 volts per cell is required. To avoid too great a current at the beginning of the

charge, a small resistance of a few hundredths of an ohm is sometimes put in series with the battery. The types of generators suitable for charging storage cells are briefly discussed in section 102, page 223.

During the process of discharge of a lead-acid cell, lead sulphate is formed at both the positive and negative plates of the cell. If the cell is allowed to stand for a considerable time, this sulphate will gradually harden and become more difficult to reduce on the subsequent charging. When this has occurred, the cell is said to be "sulphated." Sulphation of lead cells is generally the result of neglect. It is desirable that a cell which has been discharged should be charged promptly. If it is not possible to restore a lead cell to its normal condition by charging, it may be possible to overcome the difficulty by pouring out the electrolyte and filling the cell with ordinary water, again charging the cell. The nickel-iron cells may be left in a discharged condition without damage.

Both the lead-acid and the nickel-iron cells show a temporary loss of capacity when allowed to stand idle for any considerable period of time. This loss of capacity is caused by local action within the cells, but they also become sluggish—that is to say, they will not give their full capacity after normal periods of charging. In such cases it is necessary to completely charge and discharge the cells several times to restore them to their normal condition.

The cells of both the lead-acid type and the nickel-iron type show a temporary loss of capacity at low temperatures. Between ordinary room temperatures and freezing temperatures the capacity of the lead cells decreases nearly proportionately as their temperature is lowered. The nickel-iron cells, however, have a critical temperature which varies with the rate of discharge. Below this critical temperature the output of these cells will be small, but above the critical temperature practically their full capacity can be obtained. The critical temperature for these cells when discharged at the normal rate is slightly above the freezing point of water. If it is necessary to use storage cells at temperatures near freezing, the lead cell is to be preferred. In hot weather either type of cell may be used, but for the lead cell the specific gravity of the electrolyte should be somewhat reduced.

The internal resistance of a storage cell of either kind is very small and for many purposes may be neglected entirely. The resistance increases toward the end of the discharge to more than double the resistance when fully charged. When such a cell is recharged, the internal resistance falls again to its original value if the temperature remains the same. The internal resistance of lead cells is less than for the nickel-iron cells of similar capacity. It is dangerous to short-circuit either type of cell, since excessive currents may be produced.

The electrolyte for the lead-acid cells consists of chemically pure sulphuric acid and water. The specific gravity of this electrolyte varies somewhat with the type of cell and the use for which it is intended. Most portable cells, however, require an electrolyte having a specific gravity of 1.280. Electrolyte is to be added to the cells only in case of loss due to spilling, a cracked jar, or necessary replacement of all of the electrolyte due to accumulated impurities. It should never be added merely to raise the specific gravity or to replace evaporation. When it is necessary to prepare this electrolyte, the water and the acid should be mixed by pouring the acid slowly into the the water, stirring constantly. The water should never be poured into the acid on account of danger to the person making the mixture. This electrolyte should be prepared in an earthenware or glass jar and never in any metallic receptacle excepting a lead-lined tank.

The electrolyte for the nickel-iron cells usually consists of a water solution of potassium hydroxide, to which small amounts of lithium hydroxide and other substances have been added, in accordance with the manufacturer's formula. Electrolyte for these cells should be obtained from the manufacturers. It may be obtained in either liquid or dry form. If it is in the dry form, it must be dissolved in pure water, in accordance with the directions on the package. The electrolyte in these cells does not change in density as the cells are charged and discharged, but a gradual diminution of the density is observed when they have been in use for a long time. When first prepared, the electrolyte should have a density of about 1.220. The electrolyte should be renewed when the density has fallen to 1.160. In some cases sodium hydroxide has been used as

the electrolyte for these cells. This is a cheaper material, but the potassium hydroxide electrolyte is to be preferred.

The Bureau of Standards has issued Circular 92, "Operation and Care of Vehicle-Type Batteries," which contains additional information on this subject. The care and use of both the acid and the alkaline types of storage cells are treated in Signal Corps Training Pamphlet No. 8. (See p. 576.)

E. Electric Circuits.

23. Current Flow Requires a Complete Circuit.—In order to maintain a steady flow of current, there must be a continuous conducting path. This path is called the "electric circuit," and it must extend out from the generator and back to it again. The amount of current which flows will be larger as the resistance of the circuit is less. If some part of the circuit is made of very high resistance material, the current which is maintained is relatively small. The complete circuit consists of two parts, (a) the external part of the circuit, which connects the poles of the battery or dynamo outside; and (b) the internal part of the circuit, which is made up of the liquid conductor of the battery or the wires in the dynamo. When the wire of a complete circuit is cut and the ends separated, the circuit is said to be opened or broken. If the ends of the wire are again joined, the circuit is said to be closed.

Current Value Does not Vary Along the Circuit.—The beginning student often has the idea that a current may start out from a source at a given strength and then in some way become used up or dwindle away as it goes on along the circuit. This is entirely a wrong conception and, at the outset, it must be understood that in simple circuits for steady currents, in which we are dealing with resistance only, the current has the same value at every point in the circuit which is under consideration. As an illustration of this, consider the circuit of Fig. 31, made up of a battery or dynamo G , a lamp e , and a resistor R . If the circuit is cut at a , b , c , or at any other point, and a current-measuring instrument (an ammeter) inserted, it will indicate the same value of current. What this value may be is determined of course by the voltage applied and the total resistance in the circuit, but whatever its value,

it is constant throughout the circuit. This is not necessarily the case with a.c. circuits, which have distributed capacity effects, especially with the high-frequency alternating currents used in radio communication. (See Sec. 139.) But for the ordinary low-frequency alternating currents used commercially for lighting and power, the current has practically the same value in all parts of the circuit.

The same idea may be applied to a circuit such as that shown in Fig. 32. The total current I divides at a into two parts, i_1 and i_2 . The sum of these components is exactly equal to I . In other words, whatever current flows up to the point a , flows away from there. Also the currents i_1 and i_2 unite again at b to form the current I , which has the same value as before.

Another important law is that the sum of the voltage drops in every part of the circuit, including the generator, is equal to the emf. of the generator. This has already been explained in connection with Ohm's law, Section 16.

24. Series and Parallel Connections.

(a) *Resistances in Series.*—If several resistors are connected as shown in Fig. 33, so that whatever current flows through one of them must flow through all the others, they are said to be in "series." The single equivalent resistance which may replace the entire group without changing the value of the current, is equal to the sum of the separate resistances. This may be proved as follows. The voltages across R_1 , R_2 , R_3 , etc., may be represented by E_1 , E_2 , E_3 , etc. We may then write

$$E_1 = R_1 I$$

$$E_2 = R_2 I$$

$$E_3 = R_3 I$$

Since the over-all voltage between a and b is the sum of the voltages across the separate parts of the circuit, we may write for the total voltage E ,

$$\begin{aligned} E &= E_1 + E_2 + E_3 = R_1 I + R_2 I + R_3 I \\ &= I[R_1 + R_2 + R_3] \\ &= IR \end{aligned} \tag{18}$$

where R replaces the sum of all the terms in the brackets and is seen to be the sum of the separate resistances.

If a number of equal resistances are connected in series, we may write for the equivalent resistance of the group,

$$R = nr \quad (19)$$

where n is the number and r is the resistance of each. When resistances are connected in series, it must be remembered that the current through each resistance is the same and the total voltage is subdivided among the various parts of the circuit.

(b) Resistances in Parallel.—If several resistances are con-

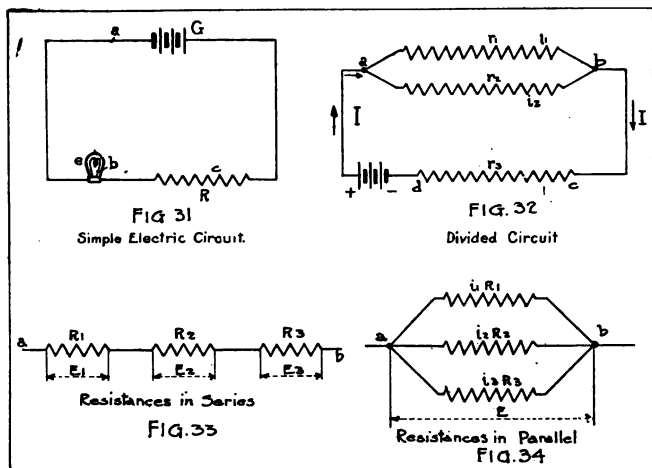

nected as shown in Fig. 34, so that only a part of the current passes through each resistance, they are said to be connected in "parallel" or "multiple." The voltage E between points a and b is the same over any branch. We may then write, from equation (11),

$$i_1 = \frac{E}{R_1} \quad i_2 = \frac{E}{R_2} \quad i_3 = \frac{E}{R_3}$$

Since the total current must be the sum of the three branch currents, we may add the three equations and

$$i_1 + i_2 + i_3 = I = E \left[\frac{1}{R_1} + \frac{1}{R_2} + \frac{1}{R_3} \right]$$

or

$$\frac{I}{E} = \frac{1}{R_1} + \frac{1}{R_2} + \frac{1}{R_3} \quad (20)$$

From equation (9) it appears that the voltage divided by the current gives the resistance, hence the left-hand member of equation (20) is the reciprocal of the equivalent resistance, or $\frac{1}{R}$.

Hence

$$\frac{1}{R} = \frac{1}{R_1} + \frac{1}{R_2} + \frac{1}{R_3} \quad (21)$$

Two resistances in parallel occur so often in practice that it is well to consider this case further. Solving equation (21) for R when there are only two component resistances we have,

$$R = \frac{R_1 R_2}{R_1 + R_2} \quad (22)$$

Thus, two resistances in parallel have a joint or equivalent resistance, given by the product of the resistances divided by their sum.

When there are a large number of single resistances, all of the same value, in parallel, it can be shown that the equivalent resistance of the group is given by

$$R = \frac{r}{n} \quad (23)$$

where r is the value of one resistance, and n is the number of them.

When resistances are connected in parallel it must be remembered that the voltage across ab , Fig. 34, is constant, and the total current is subdivided among the several branches.⁸

(c) *Batteries in Series and Parallel.*—It is frequently necessary, when using batteries, to increase the effect which a single cell can produce. This is done by connecting the cells in any one of three ways:

1. In series. Here the + side of one cell is connected to the — side of the next one, and so on for all the cells. (Fig. 37.)

2. In parallel. In this case all the + terminals are connected together and all the — terminals are connected together. (Fig. 38.)

⁸ *Exercise 1.*—A current of 42 amperes flows in a circuit, Fig. 35, and divides into three parts in the three branches, of resistance 5

3. In a combination of series and parallel groups. Several groups of cells in series may be connected in parallel, Fig. 39, or several groups of cells in parallel may be connected in series. (Fig. 40.)

The proper combination to use in any given case is dependent upon circumstances, but in general a series arrangement builds

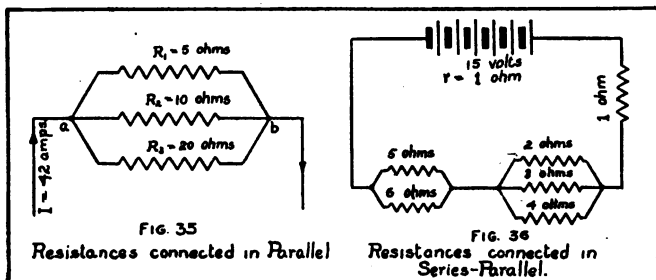

up voltage, but at the same time it increases the internal resistance, while a parallel arrangement, by decreasing the internal resistance, while a parallel arrangement, by decreasing the internal

ohms, 10 ohms, and 20 ohms, respectively. Find the current in each branch.

Solution.—The total resistance R between a and b is given by

$$\frac{1}{R} = \frac{1}{5} + \frac{1}{10} + \frac{1}{20}$$

$$R = \frac{20}{7} \text{ ohms.}$$

The RI drop between a and b is, from equation (10), $E = \frac{20}{7} \times 42 = 120$ volts. The several currents may then be calculated from Ohm's law.

$$i_5 = \frac{120}{5} = 24 \text{ amperes.}$$

$$i_{10} = \frac{120}{10} = 12 \text{ amperes.}$$

$$i_{20} = \frac{120}{20} = 6 \text{ amperes.}$$

Exercise 2.—A battery of internal resistance 1 ohm and 15 volts emf. is sending current through a circuit with resistances as shown in Fig. 36. Find (1) the total current, (2) the RI drops across resistances marked 1, 4, and 5 ohms, (3) the currents through the resistances marked 1, 4, and 5 ohms.

resistance, permits greater current to flow. If we represent the number of cells by n , the emf. of each cell by E , the internal resistance of one cell by r , and the external resistance by R , we may write Ohm's law for each of the above cases.

For series arrangement,

$$I = \frac{nE}{R + nr} \quad (24)$$

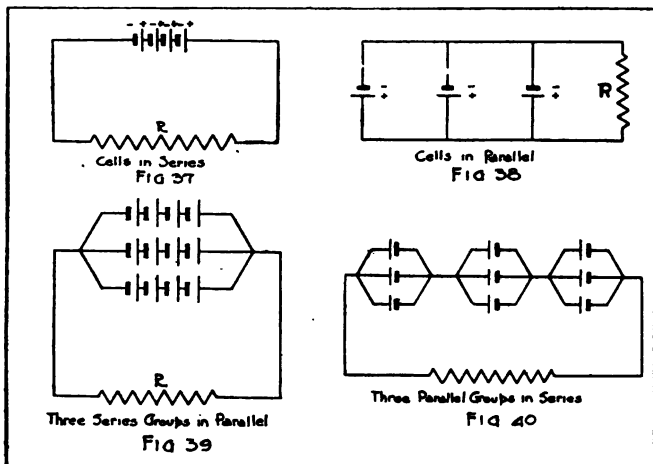

For parallel arrangement,

$$I = \frac{E}{R + \frac{r}{n}} \quad (25)$$

For n cells in series in each group, and m such groups in parallel,

$$I = \frac{nE}{R + \frac{nr}{m}} \quad (26)$$

If it is desired to build up a large current through R with a given number of dry cells, especially when their internal resistance has become relatively large through age, a series arrangement may actually cause the internal resistance to increase

faster than the voltage. Hence, adding cells in series would result in a decrease of current. The best use of a given number of cells to produce a stated current, under fixed external circuit resistance, can only be determined by a careful application of Ohm's law and the above equations, having the entire circuit in mind.*

In general the largest current from a given number of cells will be obtained when they are so grouped that the internal resistance of the battery is equal to the external resistance of the circuit. Batteries will be connected in series when the external resistance is large, and in parallel when the external resistance is small. In lighting systems, with many incandescent lamps in parallel, the lamp resistance is large compared to the line resistance, and very nearly the full voltage is realized at the lamp socket.

25. Divided Circuits. The Shunt Law.—Electric circuits are frequently arranged so that the total current is subdivided, and made to flow through two or more branches in parallel. As shown in Fig. 41 the total current I divides into two parts,

* *Exercise.*—Assume a battery of two dry cells in series, each cell having an emf. of 1.5 volts and an internal resistance of 0.3 ohm. Each battery then has an emf. of 3 volts and an internal resistance of 0.6 ohm. Suppose that the external resistance in the circuit is 0.2 ohm, and that a current of 6 amperes is to be established.

Solution.—If we try one battery, Ohm's law gives

$$I = \frac{3.0}{0.2 + 0.6} = 3.75 \text{ amperes.}$$

This is not enough current, so we try two batteries in series,

$$I = \frac{6.0}{0.2 + 1.2} = 4.28 \text{ amperes.}$$

The current is still too small and it is seen that although the voltage has been doubled, the current has only been increased by about 14 per cent. Trying three batteries in series,

$$I = \frac{9}{0.2 + 1.8} = 4.5 \text{ amperes.}$$

This is still too small and only represents an increase of 20 per cent, although the voltage was increased threefold. We will now try an arrangement of two batteries in parallel,

$$I = \frac{3}{0.2 + \frac{0.6}{2}} = 6.0 \text{ amperes.}$$

i_1 and i_2 , which flow in branches r_1 and r_2 , respectively. When so arranged, either branch is called a *shunt* (side track or by-pass) with respect to the other. The voltage between points a and b is of course the same over either of the branches. We may then write,

$$i_1 = \frac{E}{r_1} \quad (a)$$

$$i_2 = \frac{E}{r_2} \quad (b)$$

Dividing (a) by (b) we have

$$\frac{i_1}{i_2} = \frac{r_2}{r_1} \quad (27)$$

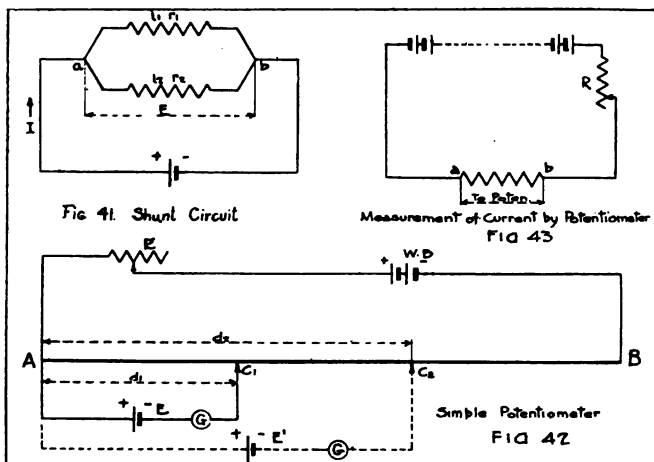

The currents in the two branches are inversely proportional to the resistances of their respective paths. This relation is called the "shunt law." In other words, it means that the branch of lower resistance carries the larger current, and the branch of higher resistance carries the smaller current.

This law is of constant application in electric circuits. Suppose that the only ammeter available is one with a scale range of 0-5 amperes, and suppose that a current of 50 amperes has to

be measured. The shunt law at once suggests that we may proceed as follows: With 50 amperes flowing in the main circuit, and with 5 amperes as the safe current through the ammeter, a shunt s must be provided capable of carrying the rest of the current or 45 amperes. We may then write from equation (27),

$$\frac{i_a}{i_s} = \frac{5}{45} = \frac{s}{r} \quad (28)$$

where r is the resistance of the ammeter, s is the resistance of the shunt, i_a is the current through the ammeter, and i_s is the current through the shunt.

Then
$$s = \frac{1}{9} r$$

Thus to carry the required amount of current, the shunt resistance must be one-ninth of that of the ammeter.

Equation (28) can be written

$$\frac{i_s}{i_a} = \frac{r}{s}$$

Hence

$$1 + \frac{i_s}{i_a} = 1 + \frac{r}{s}, \text{ and } \frac{i_a + i_s}{i_a} = \frac{s + r}{s}$$

Hence if we write I for the total current $i_a + i_s$,

$$i_a = I \left[\frac{s}{s+r} \right] \quad (29)$$

The factor $\frac{s+r}{s}$ is called the "multiplying factor" of the shunt, and is in the above case equal to 10.

26. **The Potentiometer.**²⁰—The potentiometer is primarily an arrangement of circuits for measuring potential difference or voltage. With the aid of certain accessories it can be used for measuring voltages over all ranges, and by means of Ohm's law these measurements can be applied to the determination

²⁰ The word "potentiometer" is used here in its original sense, meaning an arrangement of circuits for measuring potential difference. In apparatus catalogues and in textbooks on radio circuits the word is often inaccurately used in the sense of a voltage divider. (See Sec. 15.)

of a wide range of current values. A uniform homogeneous wire, usually a meter or more in length (Fig. 42), is stretched between binding posts on a baseboard, by the side of a graduated scale. In series with this wire is a constant source of current, usually a storage battery WB and a variable resistor R . From equation (10) it is clear that by properly adjusting R the voltage between A and B can be varied through wide limits. Let us assume that (1) the end A is connected to the $+$ side of the battery WB , (2) the resistance of AB is uniform from end to end, and (3) the current through AB is constant and of such a value that the RI drop along the wire is about 2 volts. If a standard cell, of voltage E (about 1.0183), has its $+$ pole connected to the point A , a certain point c_1 can be found, such that when contact is made at this point, the galvanometer g (see Sec. 60) will show no deflection. The absence of deflection on the galvanometer means that the RI drop in the wire AB up to the point c_1 is just equal, and opposed to the voltage of the standard cell. The distance Ac_1 may be represented by d_1 . Now let some other cell E' , whose voltage is to be tested, be put in place of the standard cell E . If the voltage of this cell does not exceed the RI drop in AB , another point c_2 can be found, for which there is no current through the galvanometer. The distance Ac_2 may be called d_2 , and the RI drop over this length of wire is just equal and opposed to the voltage of the cell E' to be tested. Since the RI drops along the wire are directly proportional to the lengths, we may write

$$\frac{E}{E'} = \frac{d_1}{d_2}$$

and

$$E' = E \frac{d_2}{d_1} \quad (30)$$

This simple form of the apparatus is only capable of measuring a voltage not much greater than that of the standard cell. If very much higher voltages are to be measured, the high voltage is put across the terminals of a voltage divider (Sec. 15), and some definite fraction of it is then measured against the standard cell, as described above.

Also, any range of current can be measured by means of the potentiometer. The current to be measured is passed through

a standard resistance ab of known value R , Fig. 43. This is so chosen that the RI drop across it lies within the voltage range of the potentiometer. The determination of current then consists in measuring the voltage across ab in terms of the standard cell, and calculating the current by Ohm's law.

27. **The Wheatstone Bridge.**—This is a simple circuit for measuring an unknown resistance in terms of a known resistance. The method depends upon the fact that in a branched circuit, Fig. 44, the voltage drop from a to c must be the same over the path abc as it is over the path adc . It then follows that for any point b which may be chosen on the upper circuit abc there must be some point d on the lower branch, such that there will be no difference of potential between it and the point b . The point d can be found by connecting one terminal of a galvanometer at b and moving the contact point connected to the other terminal along the lower wire until there is no deflection. This means that there is no current flowing, and hence no potential difference between b and d . When the points b and d have been located in this way, it can be shown that there is a simple definite relation between the resistances of the four arms of the circuit. (See Fig. 45.)

If I_p is the current through the top branch and I_t is the current through the bottom branch, then the voltage drop between a and b is $r_1 I_p$, and is equal to $r_3 I_t$, the voltage drop between a and d . Hence

$$r_1 I_p = r_3 I_t, \text{ and } \frac{r_1}{r_3} = \frac{I_t}{I_p}$$

Likewise it is seen that

$$r_2 I_p = r_4 I_t, \text{ and } \frac{r_2}{r_4} = \frac{I_t}{I_p}$$

Whence

$$\frac{r_1}{r_3} = \frac{r_2}{r_4}$$

or

$$r_4 = r_3 \frac{r_2}{r_1} \quad (31)$$

If three of the resistances are known, the fourth, r_4 , can be easily calculated from this equation.

In practice the branch adc may be made from a long, uniform, and homogeneous wire, in which case it is not necessary to know the resistance values. If the portion abc is such a wire,

the ratio of the length l_1 and l_2 of the segments will be the same as the ratio of the resistances. The equation (31) may then be written

$$r_4 = r_3 \frac{r_2}{r_1} = r_3 \frac{l_2}{l_1}$$

28. Heat and Power Losses.—In Section 7 it was shown that when current flows through a resistance, heat is generated in it. It is important to understand that this effect does not refer to heating the resistor to a definite temperature, but rather it has to do with the generation of heat at a definite rate. This rate may be expressed in joules per second, calories per second, watts, or horsepower. When the rate of supply of heat due

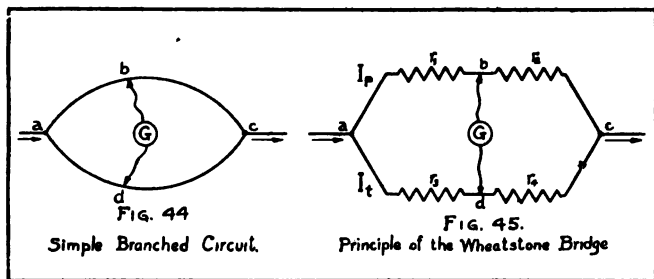

to the electric current is just equal to the rate of loss of heat by conduction or radiation, then the temperature becomes constant. The final temperature of any resistance coil through which current is passing depends upon its surroundings. If it is open to the air, radiation is more free. In coils which are inclosed, the temperature may rise rapidly and unless care is taken, the insulation may be softened or even burned.

When the heat is dissipated at as fast a rate as it is produced, so that the temperature of the resistor remains constant, the resistance becomes constant.

$$\text{Equation (2) is} \quad W = RI^2t \quad (2)$$

Since from Ohm's law, $I = \frac{E}{R}$ we may write

$$W = R \frac{E^2}{R^2} t = \frac{E^2}{R} t \quad (32)$$

Again substituting

$$R = \frac{E}{I},$$

we have

$$W = \frac{E^2 It}{E} = EIt. \quad (33)$$

These three equations will give the energy in joules when amperes, ohms, volts, and seconds are used.

Power is the time rate of change of energy. If the three equations above are divided by the time t , we have the corresponding three equations for power.

$$P = \frac{W}{t} = RI^2 \quad (34)$$

$$P = \frac{E^2}{R} \quad (35)$$

$$P = EI. \quad (36)$$

Exercise 1. What power is required to operate 1,000 incandescent lamps, each of which requires $\frac{1}{2}$ ampere and 110 volts?

First solution.—From equation (36), each lamp requires

$$\frac{1}{2} \times 110 = 55 \text{ watts.}$$

For 1,000 lamps—

$$\begin{aligned} 1000 \times 55 &= 55,000 \text{ watts} \\ &= 55 \text{ kw.} \end{aligned}$$

Since

$$746 \text{ watts} = 1 \text{ horsepower,}$$

$$\frac{55,000}{746} = 73.7 \text{ h.p.}$$

Second solution.—The resistance of each lamp is given by

$$R = \frac{E}{I} = \frac{110}{\frac{1}{2}} = 220 \text{ ohms.}$$

Using equation (34)

$$P = 220 \times \frac{1}{2} = 55 \text{ watts for 1 lamp.}$$

For 1000 lamps—

$$P = 1000 \times 55 = 55 \text{ kw.}$$

Exercise 2.—An instrument has 1210 ohms resistance in its coils, and a voltage of 110 volts is impressed. Calculate the rate of dissipation (watt-loss) in the coils.

F. Capacity.

29. **Dielectric Current.**—So far, only steady currents and their flow in conductors have been considered. In a perfect insulating material a steady current can not flow. If an electromotive force is applied between two points of an insulator, a momentary flow of current takes place which soon ceases. The current flow is very different from that in a conductor. If a very sensitive indicator of current g , Fig. 46, is connected

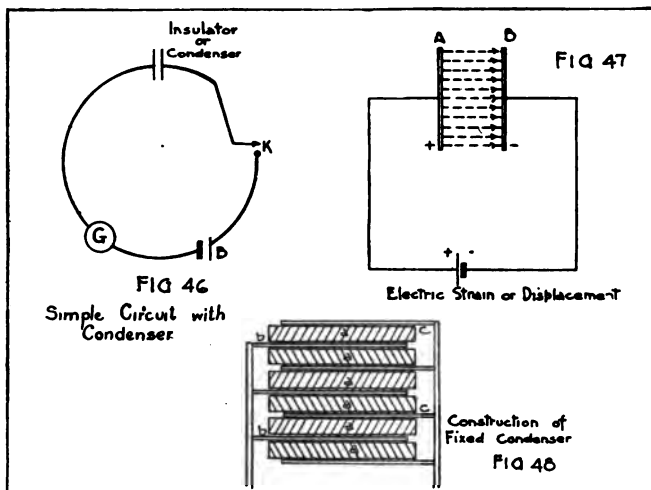

into the circuit, it shows a sudden deflection when the key is closed. This deflection soon drops to zero. The momentary flow of electricity is due to the production of a sort of electric strain or "displacement" of electricity. This is resisted by a sort of elastic reaction of the insulator that may be called electric stress. On account of this reaction of the electric stress, the electric strain due to a steady applied emf. reaches a steady value, and the current becomes zero. When the electric strain is subsequently allowed to diminish, a current again exists in the opposite direction. A current of this kind, called a "displacement current," exists only when the electric strain or displacement is changing. When considering

the existence of electric strain or displacement in an insulating material, the material is called a "dielectric," and the displacement current is sometimes called a "dielectric current."

We do not think of this electric displacement as being due to the actual passage of matter, on which the charge is carried from one plate to the other, nor even from one molecule to another within the substance. It is rather as if, in each molecule, a positive charge is moved to one end and a negative charge to the other. Then with all the positive charges pointing in one direction, the effect is that a certain change has been transmitted clear across the dielectric. An illustration may aid in making this idea clearer. In a dense crowd of people a sudden push or shove on one person will be sent through from person to person. Energy is transmitted, and yet no single person has passed all the way across.

When a dielectric is in the electrically strained condition it possesses potential energy in the "electrostatic" form. (For a brief discussion of energy, see Circular 74, p. 9.)

30. **Condensers.**—Displacement is produced in a dielectric by placing the dielectric between metal plates and connecting a battery or other source of emf. to these plates. Such an arrangement consisting of metal plates separated by a nonconducting material is called a condenser. Thus in Fig. 47, *A* and *B* are the metal plates of the condenser. The dotted lines indicate the directions of the electric strain or displacement. The plate from which the displacement takes place is called the positive or + plate of the condenser. Conversely, the other plate is called the negative or — plate. The dielectric may be air or other gas, or any solid or liquid that is not a conductor. When the battery is connected to the condenser a displacement current begins to flow, continuing until the electric displacement reaches its final or steady value. The displacement produced depends upon (*a*) the voltage applied to the condenser and (*b*) the kind of dielectric. A continuous or direct current can flow only in conductors. An alternating current, in which the direction periodically changes sign, can flow also in condensers in the form of a dielectric current. (See Sec. 56.) In this case, the electric strain or displacement reverses its direction with every reversal of the current. The existence of the electric strain or displacement in the dielectric

is equivalent to the presence of a certain quantity or charge of electricity.

For a given condenser, its charge Q is found to be directly proportional to the applied voltage E . This relation may be written

$$Q = CE \quad (37)$$

where C is a constant. For any given condenser the value of this constant is seen to be the ratio of the charge to the voltage, or

$$C = \frac{Q}{E} \quad (38)$$

This constant C is called the "capacity" of the condenser. The unit of capacity is the "farad," which is defined in Appendix 2, page 549. This unit is too large for practical purposes, and it is usual to use the microfarad, which is one one-millionth of a farad, and the micromicrofarad, which is one one-millionth of a microfarad.

The capacity changes when different dielectric materials are used. If the plate area is increased, the capacity increases in direct ratio, and as the plates are brought closer together, the capacity increases. (Formulas for calculating the capacity of condensers are given in Circular 74, p. 235, and also in this book in section 32, p. 96, and section 170, p. 384.)

Charging of Condensers.—During the brief time in which the charge is accumulating in a condenser, the voltage $\frac{Q}{C}$ due to this charge is increasing. This voltage tends to oppose the applied or charging voltage. When $\frac{Q}{C}$ has become equal to E , the charging process comes to an end. It will be noticed that equation (37) does not contain a time factor; therefore the same amount of charge is stored in a condenser whether it is built up slowly or quickly. However, the rate of building up the charge depends upon the value of the capacity and resistance of the circuit. The larger the product of the factors C and R the greater is the time required to arrive at any given fraction of the applied voltage. THIS PRODUCT CR IS CALLED THE TIME CONSTANT OF THE CIRCUIT.

31. Dielectric Properties.—A simple experiment will show that the charge accumulated in a condenser, for a given voltage and distance apart of the plates, depends upon the kind of dielectric

material. A pair of plates with dry air between them is charged by a certain emf., and the quantity or amount of charge is measured by some suitable means. If now a slab of paraffin be inserted between the plates, it is found that for the same voltage the charge is increased. Denoting the capacity with air by C_a and the capacity with paraffin by C_p , we may write

$$\frac{C_p}{C_a} = K$$

where K is a constant. By simply changing the dielectric material, and without changing the geometric arrangement of the plates, we find that the capacity has been increased. Air is commonly used as the standard of comparison, and the factor K is called the "dielectric constant"¹¹ of the material. *The dielectric constant of any substance may then be defined as the ratio of the capacity of a condenser using this substance as the dielectric, to the capacity of the same condenser with air as the dielectric.* This ratio is seen to be the factor by which the capacity of an air condenser must be multiplied in order to find the capacity of the same condenser when the new substance is used. Some values are given below.

Substances.	Values of dielectric constant
Air.....	1.0
Glass.....	4 to 10
Mica.....	4 to 8
Hard rubber.....	2 to 4
Paraffin.....	2 to 3
Paper, dry.....	1.5 to 3.0
Paper (treated as used in cables).....	2.5 to 4.0
Porcelain, unglazed.....	5 to 7
Sulphur.....	3.0 to 4.2
Marble.....	9 to 12
Shellac.....	3.0 to 3.7
Beeswax.....	3.2
Silk.....	4.6
Celluloid.....	7 to 10
Wood, maple, dry.....	3.0 to 4.5
Wood, oak, dry.....	3.0 to 6.0
Molded insulating material, shellac base.....	4 to 7
Molded insulating material, phenolic base ("bakelite").....	5.0 to 7.5
Vulcanized fibre.....	5 to 8
Castor oil.....	4.7
Transformer oil.....	2.5
Water, distilled.....	81.0
Cottonseed oil.....	3.1

¹¹ Sometimes called also "inductivity" or "specific inductive capacity."

A wide variation is seen in the values given for some substances. The different grades and kinds of different materials vary considerably in many of their physical properties, including their electrical properties. For instance, there are a very large number of kinds of glass made for different purposes, having very different properties. Many substances absorb a small amount of water very easily, and in some substances the presence of a small amount of water will considerably increase the dielectric constant. The value of the dielectric constant also depends on the kind of voltage applied and the manner in which it is applied. If the current is supplied by a source of direct current, such as a battery, the values of the dielectric constant found when the condenser is charged slowly will differ considerably from the values found when the condenser is charged rapidly. If the voltage applied is from a source of alternating current, the values of the dielectric constant may differ considerably from the values for direct current. This is particularly true if the alternating current has a very high frequency, such as is used in radio communication. For accurate results the conditions under which the material is to be used must be stated.

Dielectric materials are not perfect insulators, but do have a very small electric conductivity. A condenser will permit a very small current to flow through it continuously when a voltage is applied to its terminals, and it will discharge itself slowly if allowed to stand with its terminals disconnected. This is called the "leakage" of the condenser. Materials differ greatly in this respect. A pair of plates with dry air as dielectric will retain the charge almost indefinitely after the voltage is cut off, while in some paper condensers the charge disappears by leakage in a few minutes.

If an emf. gives a condenser a certain charge when applied for a short time and a greater charge when applied for a longer time, the dielectric is said to possess "absorption." There is a gradual penetration of the electric strain into the dielectric which requires time. When the terminals of a charged condenser are connected by a conductor, a current flows and the condenser discharges. The charge which flows out instantaneously upon discharge is called the "free charge." With some dielectrics, if the terminals are connected a second time, another and smaller discharge occurs, and this may be repeated

several times. This so-called residual charge is due to the absorbed charge, and indicates a slow recovery of the dielectric from the electric stress. In condensers made with oil or well-selected mica for the dielectric, absorption is small. It is larger with glass, and very troublesome with bakelite and similar materials. After charging such a condenser with a high voltage, the absorbed charge continues to be given up for a long time. Absorption is accompanied by the production of heat in the dielectric. This represents a loss of energy.

The ratio of the free charge of a condenser to the voltage across its terminals is called the "geometric capacity." Any measurements of capacity which make use of a prolonged time of charging yield values larger than the geometric capacity. Measurements made with high-frequency alternating currents give values which approach closely to the geometric capacity.

Summary.—An elastic body is distorted or strained by placing it under the action of a stress; and the effect produced is measured in terms of the flexibility of the material. A dielectric substance is strained electrically by placing it under the action of an emf., and the effect produced is measured in terms of the capacity of the condenser. It is of interest to note that the capacity of an electric condenser is directly analogous to flexibility or stretchability of an elastic body.

32. Types of Condensers.—In order to increase the capacity of a condenser, we may—

1. Increase the area of the plates.
2. Diminish the distance between the plates.
3. Use a substance of larger dielectric constant.

In general, condensers are classified in two groups, as they may be designed, respectively, for (a) low voltage—less than 500 volts, or (b) high voltage—several thousand volts. Increasing the plate area tends to increase the bulk and weight of the condenser. Bringing the plates very close together makes necessary the use of a substance of high dielectric strength if the voltage is high. For low-voltage service, where large capacity is essential, the condenser plates are made of tin foil with thin sheets of mica or paraffined paper between them. The sheets are piled up as shown in Fig. 48, page 89. The dielectric layers are represented by *aa*, and the two sets of conducting plates by *bb* and *cc*, respectively. These are pressed into a compact

form and held in place by a clamp and the composite stack is saturated and sealed with melted paraffin or wax. If the condenser must withstand a very high voltage, the plates will be more widely separated, and usually air or oil is used as the dielectric. If it is desired to have the capacity of the condenser variable instead of fixed, the construction usually takes the form shown in Fig. 49, page 95. Two sets of interleaved plates are insulated from each other, and one set is mounted so that it can be rotated with respect to the other. Such a condenser

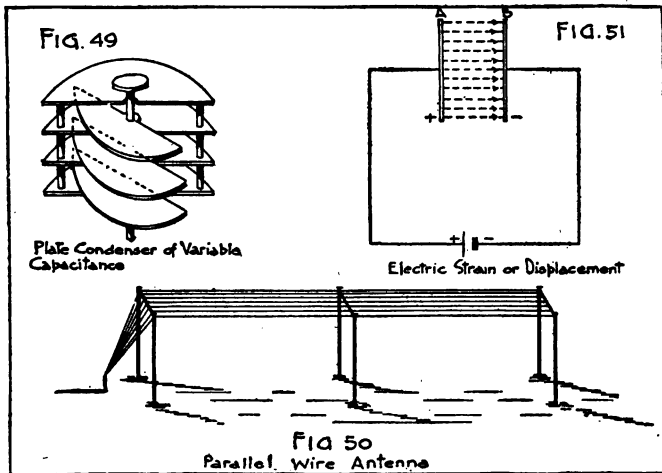

can be calibrated so that the capacity corresponding to any angular setting of the rotating part is known. Condensers used in radio circuits are represented by certain symbols. These symbols may be found in Appendix 3, page 553.

It is not always necessary that the conducting plates in the condenser should be of sheets of metal. The earth is a conductor and frequently replaces one plate in the system. A wire stretched on a pole line forms one plate of a condenser, and the other plate may be the neighboring return wire of the circuit, or it may be the earth itself. Several wires in a connected group will have more capacity with respect to the earth than a single wire. Such a condenser is the radio antenna. (Fig. 50.) The

conducting core of a submarine cable forms one plate of a condenser, the insulating material is the dielectric, and the sea water is the other plate. Similarly in a telephone cable, paper is the dielectric, and any single conductor of the cable may be regarded as one plate, the other plate being the adjacent wire of the pair or the lead sheath of the cable itself. The great length of such wires and cables gives them large surface and hence large capacity. A mile of standard sea cable may have a capacity of about $\frac{1}{3}$ microfarad. A mile of standard telephone cable should not have capacity of more than about 0.08 microfarad. The capacity of a pair of No. 8 copper wires, 1,000 feet in length and 12 inches apart, is about 0.0032 microfarad. Two square plates 10 cm. on a side, separated by 1 mm. of dry air, have a capacity of approximately 100 micromicrofarads.

In radio apparatus, particularly in the more sensitive types of receiving apparatus, very small capacities may be of much importance, such as the capacity between two short adjacent wires, or the capacity between a connecting wire and the walls of the room or other adjacent object. A sphere 1 inch in diameter has a capacity to the walls of an ordinary room somewhat over 1 micromicrofarad, and as small a capacity as this may be of importance in the design of radio apparatus.

The capacity of a condenser composed of two parallel metal plates of the same size and shape, separated by a uniform dielectric, is given by the formula

$$C=0.0885 \frac{KS}{t}$$

where C is the capacity in micromicrofarads, t is the thickness of the dielectric layer between the plates in centimeters, S is the surface area of one side of one plate in square centimeters, and K is the dielectric constant of the dielectric layer. For air the value of K is 1, for the kinds of glass ordinarily used the value of K is from 7 to 8, for mica K is about 6, for paraffin K is about 2.5, and for most ordinary substances the value of K lies between 1 and 10. (See Sec. 31, p. 92.) This same formula can be used for a parallel plate condenser having the two plates of different size, providing the area of the smaller plate is used for S in the formula. For further information regarding the calculation of capacity, reference should

be made to Circular 74 of the Bureau of Standards, page 235. See also section 170 in this book.

33. **Electric Field Intensity.**—Consider the air condenser shown in Fig. 51, having an emf. E applied across its terminals. The emf. is the cause of the electric strain or displacement which is in the direction shown by the dotted lines. The emf. between the plates of the condenser is equivalent to a force acting at every point of the dielectric, which would cause a body having a charge of electricity to move. This is called the electric field intensity and is defined as the force per unit charge of electricity. The space in which this field intensity acts is called an electric field. The value of the electric field intensity at any point inside the condenser shown

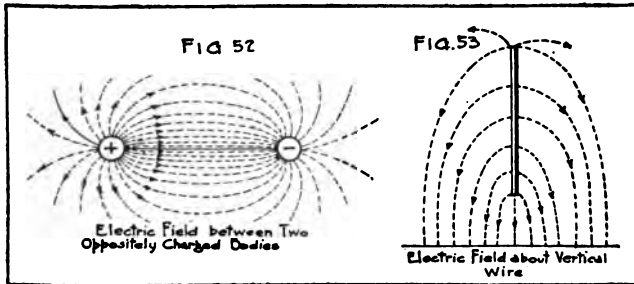

in Fig. 51 is the ratio of the emf. across the condenser to the distance between the plates. Electric field intensity ϵ is thus given by

$$\epsilon = \frac{E}{d} \quad (39)$$

where E is the emf. between two points in the dielectric a distance d apart. ϵ is commonly expressed in volts per centimeter. It is a quantity of importance in connection with electric waves.

The electric field in the condenser of Fig. 51 is the same everywhere in direction and in value. This is called a uniform field. There are many other kinds of fields. The electric field about two small unlike charges is shown in Fig. 52. Another example is given by two bodies, one of which is a long vertical

wire and the other is a conductor extended in a horizontal direction. These amount to two conductors separated by a dielectric (air), thus fulfilling the definition of a condenser. Suppose the lower body is the earth itself, which is a conductor. The field about the system will be represented by Fig. 53. This represents the form of condenser and electric field in the case of the radio antenna.

34. **Energy Stored in a Condenser.**—The electric strain in the dielectric of a charged condenser represents a store of energy. The amount of energy stored in this way is found as follows. The work done in placing a charge in a condenser is the product of the charge by the voltage between the plates. Suppose a condenser is charged by applying to it an emf. which begins at a zero value and rises to E volts. The increase in voltage is uniform, and hence the average voltage is $\frac{1}{2} E$. The energy stored in the condenser is the product of this by the charge, thus

$$W = \frac{1}{2} QE \quad (40)$$

Since $Q = CE$, from equation (37), we may write

$$W = \frac{1}{2} CE^2 \quad (41)$$

The work is expressed in joules when the capacity is in farads and the emf. is in volts. A capacity of 0.001 microfarad charged with an emf. of 20,000 volts has a store of energy given by

$$W = \frac{1}{2} \frac{0.001}{10^6} \times 20,000^2 = 0.2 \text{ joules}$$

From equation (41) it appears that time does not enter into the energy equation. For a given condenser charged to a given voltage it requires the same total amount of energy, whether the charge is acquired slowly or rapidly.

The total amount of work done in charging a condenser divided by the time, gives the rate at which energy is supplied; that is, the power supplied. This may be written,

$$P = \frac{1}{2} \frac{CE^2}{t}$$

$$P = \frac{1}{2} CE^2 N \quad (42)$$

where t is the time in seconds required to complete the charge, and N is the number of charges completed in one second of

time. If the condenser in the above problem is charged by a generator giving an alternating emf. with a frequency of 500 cycles per second, the power becomes

$$P = \frac{1}{2} CE^2N = 0.200 \times 1000 = 200 \text{ watts.}$$

It will be noted that the condenser is charged and discharged twice in every complete cycle of the a.c. generator; also that E is the maximum emf.

35. **Condensers in Series and in Parallel.**—Just as it is sometimes found convenient to combine resistances into series or parallel groups, so it is often desirable to combine condensers. The capacity of the group, however, is not calculated the same way as in the case of resistances.

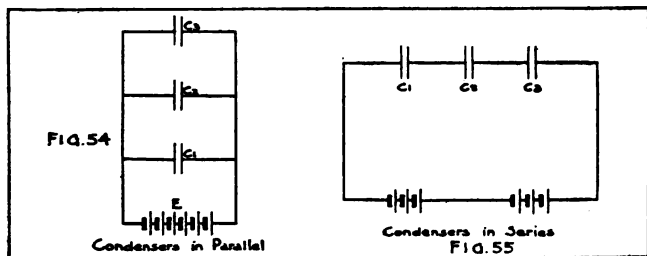

Condensers in Parallel.—Fig. 54 shows three condensers connected in parallel. The condensers are all under the same impressed emf., and they accumulate charges proportional to their respective capacities. It has been stated in Section 30 that capacity is proportional to plate area. Connecting condensers in parallel is equivalent simply to increasing the plate area. If C_1 , C_2 , C_3 , etc., represent, respectively, the capacities of the condensers of the group, and if C represents the equivalent capacity of the entire group, we may then write

$$C = C_1 + C_2 + C_3 + \dots \quad (43)$$

Parallel connection of condensers always gives a larger capacity than that of any single member of the group.

Condensers in Series.—If several condensers are connected as shown in Fig. 55 they are said to be connected in series. In finding the equivalent capacity of such a group, it must be

kept in mind that the same charge is given to each condenser, and that the total voltage E is subdivided among the condensers in direct ratio to their capacities. Using symbols as above we may then write

$$E = E_1 + E_2 + E_3 + \dots$$

or since in general $E = \frac{Q}{C}$

$$\frac{Q}{C} = \frac{Q}{C_1} + \frac{Q}{C_2} + \frac{Q}{C_3} + \dots$$

Whence
$$\frac{1}{C} = \frac{1}{C_1} + \frac{1}{C_2} + \frac{1}{C_3} + \dots \quad (44)$$

Series connection of condensers always gives a smaller capacity than that of any single member of the group. (See problems below.)

1. A condenser has a capacity of 0.014 microfarad, and it is charged with an emf. of 30,000 volts.

Find (a) the charge in the condenser, (b) the energy stored, (c) the power expended when charged by a 500-cycle a. c. generator.

2. A condenser is built up of 15 parallel and circular plates. Each plate is 20 cm. in diameter and the separation is 1 mm. Transformer oil is used as a dielectric. Calculate the capacity. (See sections 31, 32, pages 92-96, and Bureau of Standards Circular 74, page 235.)

3. Three condensers have capacities of 0.02, 0.20 and 0.05 microfarad, respectively. Find the equivalent capacity, (a) when they are all in series; (b) when they are all in parallel.

G. Magnetism.

36. **Natural Magnets.**—One of the forms in which iron is found in the earth is the black oxide of iron (chemical formula Fe_3O_4) called magnetite or magnetic iron ore. A piece of this substance is called a "natural magnet," and it has two very remarkable properties as follows:

(a) If a piece of it is dipped into iron filings the filings will adhere to it.

(b) If a piece of it is suspended by a silk thread, or by a thin untwisted cord, it will set itself with its longer axis very nearly in a north and south direction.

37. **Bar Magnets.**—A small rod of iron or steel which is brought near to a piece of magnetite, or which is rubbed on it

in a certain way, shows the same properties, and is said to be "magnetized." If the rod or bar is made of rather hard steel, the effect persists after the iron ore has been taken away, and the magnetized rod is then called a "permanent magnet," or simply a bar magnet. These permanent magnets may be made in the form of straight bars of round or square section, usually with the length rather large as compared to the diameter. They are also often bent into various shapes, a common form being the horseshoe or U-shaped magnet.

Magnets may also be made by passing an electric current through a coil of insulated wire which surrounds the rod. (See Fig. 56.) If the rod is made of soft iron, it is only magnetized as long as the current flows. It is then called a tem-

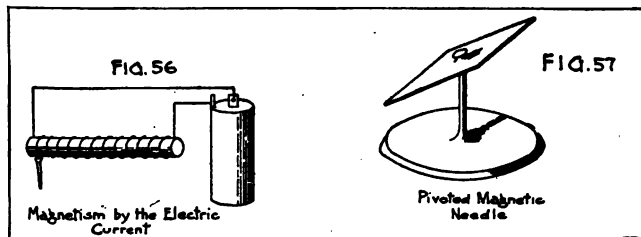

porary magnet or an "electromagnet." Examples of electromagnets are seen in induction coil and buzzer cores, in telegraph sounders and relays, and in telephone receivers. Electromagnets are very useful because the magnetism is so easily controlled by variations in the current strength. If the bars are of hardened steel, the magnetism due to the current remains after the current ceases and a permanent magnet is the result.

A slender magnetized steel rod mounted carefully on a pivot (Fig. 57) will turn very nearly into the north and south position, and is called a "compass needle." It is used by sailors and surveyors for determining directions. The end which points north is called the north-pointing or simply the "north pole." The other end is called the "south pole."

38. **The Magnetic Field.**—If a compass needle is placed at various positions near a large bar magnet, it changes its direction as shown in Fig. 58. This shows that in the space all

around the magnet there are forces which act on magnetic poles. If iron filings are sprinkled on a level sheet of paper which lies over the magnet, the filings arrange themselves as shown in Fig. 59. Each little particle of iron acts like the compass needle and points in a definite direction at a given position. These direction lines, called "magnetic lines of force," all appear to center in two points near the ends of the bar magnet. These points are called the "poles" of the magnet. Two magnetic poles are said to be alike when they both attract or both repel the same pole. If one attracts and the

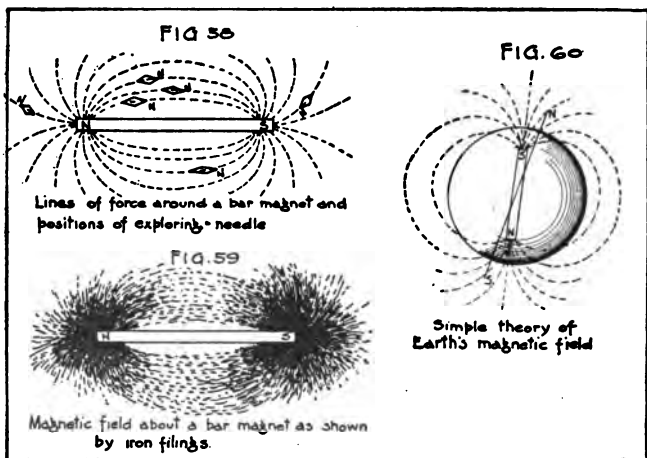

other repels the same pole, they are said to be unlike. *Like poles repel each other and unlike poles attract each other.* It is then easy to determine which is the north and which is the south pole of a bar magnet by means of the direction in which the north pole of a compass needle points.

The region all about a magnet, in which these forces on the poles of magnetic needles may be detected, is called the "magnetic field." The intensity of a magnetic field may be defined in terms of the force which acts on a given magnetic pole, or it may be defined in another way, as described in a following paragraph. The direction of a magnetic field is defined as the direction in which the north pole points.

The earth has a magnetic field about it which is represented by Fig. 60. This field is similar to that which would exist about a bar magnet placed within the earth with its ends at the magnetic North and South Poles of the earth.

39. Magnetic Flux and Flux Density.—The arrangement of the iron filings in Fig. 59 shows that there is a greater effect at some points than at others. It also suggests that the lines of force may be thought of as similar to stream lines in a moving fluid. From this point of view there is said to be a magnetic flux through the space occupied by the magnetic field. This is represented by lines drawn closer together where the field is strong and farther apart where the field is weak. The magnetic field must not be thought of as made up of filaments, like a skein of yarn, because it really is continuous. However, electrical engineers represent a magnetic flux by drawing one line through the field for each unit of the flux. The number of such lines through each square centimeter of the field perpendicular to the lines is the "magnetic induction" or "flux density" per square centimeter. A magnetic field has a flux density of one line per square centimeter when the unit of magnetic flux is distributed over a square centimeter of area, taken perpendicular to the direction of the flux.

40. The Magnetic Field About a Current.—It has already been pointed out in Section 3 that there is a magnetic field about a wire in which a current is flowing. Experiments with the compass show that this magnetic field has lines of force in the form of concentric circles about the wire. These circles lie in planes at right angles to the axis of the wire. If the wire is grasped by the right hand with the thumb pointing in the direction of the current, the fingers will show the direction of the magnetic field (Fig. 10). This field extends to an indefinite distance from the conductor, but for points farther from the wire the effect becomes more feeble, and the more sensitive must be the apparatus for detecting it. If the current stops, the magnetic field, together with its effects, disappears. When current is started through the wire, we may think of the magnetic field as coming into being and sweeping outward from the axis as a center. This disappearing and rebuilding of the magnetic field as the current decreases and increases will be

made use of in Section 46, in explaining some important principles which apply in radio circuits.

41. **The Solenoid and the Electromagnet.**—If the wire which carries a current is bent into a circle, the magnetic field is of the form shown in Fig. 61. At the center of the circle the field is uniform only for a very small area. If many turns are wound close together in what may be called a bunched winding, the intensity of the magnetic field is increased in direct proportion to the number of turns. When the wire is wound

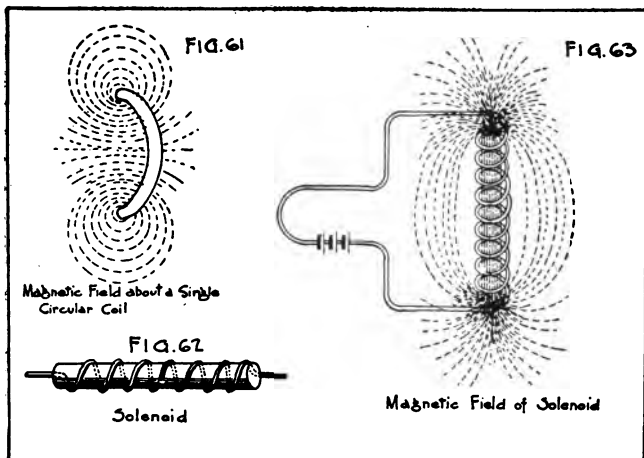

closely with many turns, side by side along the surface of a cylinder in a single layer, the coil is called a "solenoid," Fig. 62. In this case, the magnetic field is nearly uniform for a considerable distance near the center of the coil, and the solenoid has the properties of a bar magnet. This is seen by comparing the magnetic fields of Figs. 63 and 59. The intensity of the field and the magnetic flux density within the solenoid depend entirely upon the strength of the current and the number of turns of wire per centimeter. The same magnetizing effect can be secured with many turns and a weak current, or with a few turns and a strong current, provided only that the product of wire turns times amperes of current is the same in each case. This product is called the "ampere-turns." In

round numbers the magnetizing field strength, represented by the symbol H , is given by

$$H = \frac{5}{4} \left(\frac{\text{ampere-turns}}{\text{length in cm.}} \right) \quad (45)$$

If I is the current in amperes, N the total number of turns on the solenoid, and l the length of the solenoid in centimeters, the accurate formula may be written ¹²

$$H = \frac{4}{10} \pi \frac{NI}{l} \quad (46)$$

42. Magnetic Induction and Permeability.—If the space within the solenoid is filled with iron, the magnetic flux lines are very greatly increased. This is due to a property of iron called magnetic "permeability." To say that iron is more permeable than air means that the magnetism is stronger when iron is present than it would be if the space were filled with air alone.¹³ Permeability varies according to the quality of the iron, from a few units to a few thousand. For example, to say that the permeability of a certain sample of iron is 1,000 means that the magnetic flux through 1 cm. of cross section of the iron is 1,000 times as great as the flux through the same area before the iron was present. The total magnetic flux through an iron core within a magnetizing coil, divided by the area of cross section, gives the "magnetic induction," which is represented by the symbol B . We may denote total flux through the iron by ϕ_i , then

$$\phi_i = BA \quad (47)$$

where A is the area of cross section of the iron core. If the intensity of the magnetizing field within a solenoid is denoted by H , then the total magnetic flux through the solenoid is given by

$$\phi_s = HA \quad (48)$$

¹² For proof of this formula see Circular 74, p. 15.

¹³ Time is required for the magnetization to travel inward from the surface to the axis of the iron core. Hence, if the current is rapidly reversed in direction, the magnetic wave started by one-half cycle does not have time to travel inward appreciably before the reversed half cycle recalls it and starts a wave of opposite sign. As a consequence the magnetism is confined to the outer layers of the iron core. For this reason iron is not as effective in increasing the number of flux lines in high-frequency circuits as it is with steady currents or low-frequency currents.

where A is the area of cross section and ϕ is the total flux through the air core. The permeability is defined as the ratio of B to H .

It is important that the student should remember that the magnetic induction depends upon (a) the number of ampere-turns and (b) the property of iron called permeability. The number of ampere-turns is under the control of the operator. The permeability depends upon the quality of the iron itself.

If the current in the windings is reversed, the direction of the magnetic field is also reversed. The student should learn at least one rule for remembering the relation between the direction of the current and the direction of the magnetic flux. Two such memory helps are here given.

(a) If to an observer looking at one end of a solenoid the current appears to flow in a clockwise direction (i. e., in the direction of the rotation of the hands of a clock), the end next to the observer is the *south* pole.

Another way of stating this rule is to look along the direction of the lines of magnetic flux through the solenoid (from south pole to north pole) and the current is flowing in a clockwise direction.

(b) Grasp the solenoid with the right hand so that the fingers point along the wires in the direction in which the current is flowing. The thumb then points to the *north* pole; that is, the thumb points in the direction of the magnetic flux inside of the solenoid which is from south pole to north pole.

The student may verify this relation by applying to Fig. 61 the thumb rule for the direction of the magnetic field about a straight conductor carrying a current, as stated in section 4, page 30. Thus in Fig. 61, if it is assumed that in the half turn shown the current is flowing from the top of the figure to the bottom, the north pole is on the right of the turn. In Fig. 63, the current flows in at the bottom of the solenoid and out at the top, and the north pole is at the top of the figure.¹⁴

¹⁴ Apply each of the above rules to Fig. 62. Also wind an experimental solenoid with a few feet of wire, connect it to a dry cell and mark in some way the direction of current through the windings. Test its polarity with a compass, remembering that like poles repel and unlike poles attract.

43. The Force on a Conductor Carrying Current in a Magnetic Field.—If two different magnetic fields are brought together in the same space, with their directions parallel, a force is always developed. If the lines of magnetic flux are in the same direction, the two fields mutually repel one another, and if the flux lines are in opposite directions the two fields will be drawn together. When a current flows in a wire which is at right angles to a magnetic field, a force will act on the wire. A rule which will help the student to remember the direction of the motion, together with the directions of current and field, is the so-called "left-hand rule." Extend the forefinger of the left hand in the direction of the magnetic field, and hold the middle finger at right angles to it in the direction of the current. The extended thumb, held at right angles to both the other directions, indicates the direction of the motion. Note that this rule calls for the use of the left hand. Compare this with the right hand rule of Section 63.

When the wire which carries the current is at right angles to the direction of the magnetic field, the pushing force on the wire is equal to the product of the current, the intensity of the magnetic field, and the length of wire which lies in the magnetic field.

If the wire makes some other angle with the direction of the magnetic field, the direction of the force is still the same as for the right angle position, and the value of the force is smaller. In the single instance that the direction of the current coincides with the direction of the magnetic field the force is zero.

This push on a single wire is in most cases small, but by arranging many wires in a very intense magnetic field, very large forces may be obtained. The powerful turning effect of an electric motor depends upon these principles. (See Sec. 96.)

H. Inductance.

44. The Linking of Circuits with Lines of Magnetic Flux.—There is always a magnetic field about an electric current. The lines of magnetic flux are closed curves and the electric circuit is also closed. The lines of magnetic flux are then thought of as always interlinked with the wire turns of the cir-

cult. (See Fig. 64.) The number of flux lines through a coil will depend upon the current, and any change in the current will change the number of linkings. If there are two turns of wire the circuit will link twice with the same magnetic flux, and so, for any number of turns, the number of linkings increases with the number of turns. Let ϕ represent the number of magnetic flux lines, N the number of linkings and n the number of wire turns. Then it is seen that the number of linkings is always given by

$$N = n \phi \quad (49)$$

A change in N may be brought about by (a) a change in ϕ , due to a change in the current or (b) a change in the number of wire turns. Again the loop of wire, Fig. 65, not now connected to any battery, may be placed near a bar magnet, or a solenoid which has current flowing in it. Some of the flux lines will pass through the loop. The number of these flux lines is represented by ϕ as before, and every turn of wire will link with the flux lines. Then the number of linkings is given by

$$N = n \phi \quad (50)$$

which is the same expression as in the other case.

The number of flux lines may be changed by changing the number of wire turns or by changing the number of flux lines through the loop. The latter may be done by rotating the loop, or by moving it with respect to the magnet. If a solenoid is used, the change can be made by variations in the current through its coils.

45. Induced Electromotive Force.—Whenever there is any change in the number of linkings between the magnetic flux lines and the wire turns, there is always an emf. induced in the circuit. If the circuit is closed, a current will flow. This is called an induced current. Some of the ways in which this is accomplished are described in the following paragraphs.

1. A bar magnet is pushed into a closed coil of wire, Fig. 66. During the time the magnet is moving there will be indications on the galvanometer g that current is flowing. When the magnet is drawn back, away from the coil, a current is induced in the opposite direction. The direction of this induced current will always be such as to oppose the change to which it is due.

That is, if the magnet is approaching the coil, the current will flow in AB so that A is a north pole, and hence the magnet will be repelled. If the key k is open, the induced current can not flow. If it is closed, an induced current does flow, and sets up a magnetic field about the coil. It can be shown that more work is required to move the magnet with respect to the coil when the key is closed than when it is open. These facts are expressed in the law of Lenz, which states that *whenever an induced current arises, by reason of some change in linkings, the magnetic field about the induced current is in such a direc-*

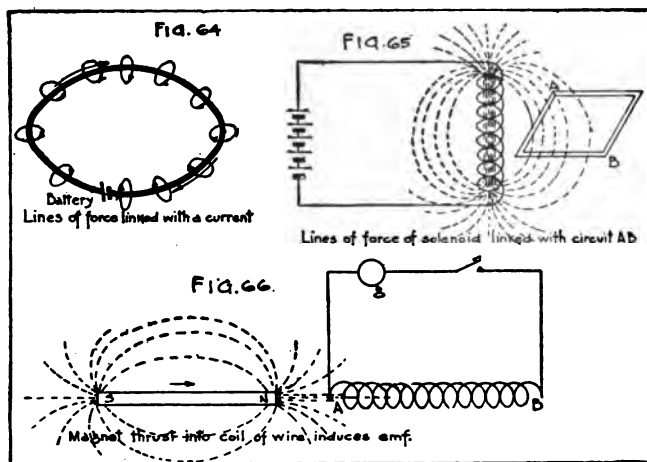

tion as to oppose the change. A helpful, mechanical illustration of Lenz's law is seen in the effort necessary to move a stationary body. Owing to the mass of the body, a force is necessary to start it, and if one tries to move it suddenly he will experience a considerable reacting force. This reacting force will be greater the more sudden the change in the motion of the body. Similarly in the electric circuit, the induced emf. will be greater the more sudden the change in the number of linkings.

2. The same effects as those described in (1) may be secured if the bar magnet is replaced by a solenoid carrying current.

3. The effects may also be produced by two solenoids fixed in the position shown in Fig. 67. If a current is started in one of them, *A*, there will be a current induced in the other, which will continue to flow as long as the current in *A* is increasing. If the current in *A* becomes steady, there is no current induced in *B*. If the current in *A* falls off, the induced current in *B* is reversed in direction. In all cases it must be remembered that the magnetic field about the induced current tends to oppose the change that is causing the induced current.

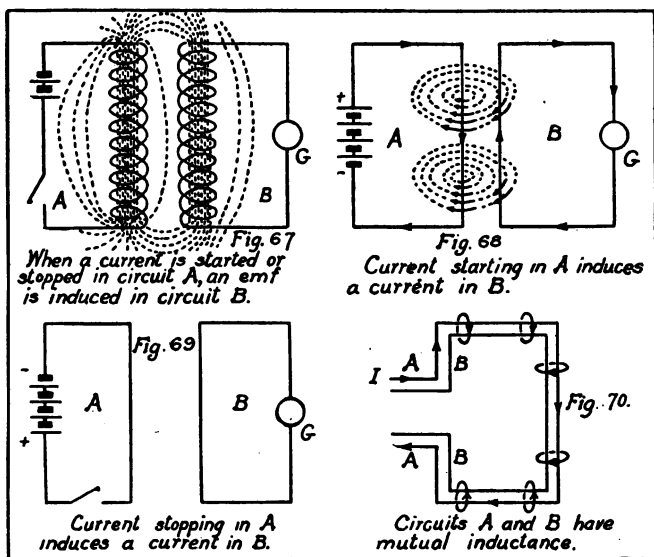

4. A further example of induced currents is found in the case of two straight wires, Fig. 68, close together. If the electric current stops (Fig. 69), starts, or varies in one of them in any way, there are corresponding induced currents in the other. This case of parallel straight wires is seen in certain telephone lines where cross talk occurs, or where there is interference from a.c. power lines. The ordinary telephone pole line has several pairs of parallel wires mounted on a single cross arm, and for purposes of minimizing cross talk it is general practice to transpose at frequent intervals the two wires composing a

pair, so that over any considerable distance the emf. induced by adjacent wires acting on a transposed pair is zero. Although we think of the straight and parallel portions of the circuit, we must not overlook the fact that these are only portions of completely closed circuits.

The magnitude of the induced emf. in all of the above cases depends upon the time rate of change of the number of linkings. This may be expressed by the equation

$$\text{Emf.} = \frac{N}{t} = \frac{n\phi}{t} \quad (51)$$

where t is the time in seconds in which the change $n\phi$ takes place. This is the basic principle of dynamo-electric machinery.

46. Self Inductance.—With a single circuit carrying current, as shown in Fig. 64, the magnetic flux ϕ which threads through the circuit (and hence the number of linkings N) is directly proportional to the current strength. This fact may be expressed by the formula

$$N = LI \quad (52)$$

where L is called the "self inductance," or simply the "inductance" of the circuit.

The value of L depends upon the number of wire turns, upon the shape and size of the turns, and upon the permeability of the medium about the circuit. For air the permeability is 1. The inductance does not depend upon the current which is flowing, except when iron is present. By coiling up a piece of wire in many turns and introducing it into the circuit, the inductance of the circuit may be greatly increased. In that case the inductance is said to be concentrated. It must not be overlooked that the entire circuit has inductance. This may be distributed more or less uniformly throughout the circuit.

The self-inductance L is measured in units called "henries." A henry is the inductance in a circuit in which the electromotive force induced is one volt when the inducing current varies at the rate of one ampere per second. In practice other smaller units are also used—the millihenry, which is one one-thousandth of a henry; the microhenry, which is one one-millionth of a henry; and the centimeter of inductance which is one one-thousandth of a microhenry. Methods of computing in-

ductance in a few special cases are given in section 170. A single layer coil wound on an empty cylindrical tube 5 inches in diameter, 11 inches long, having a total of 150 turns, has an inductance of a little over one millihenry.

If a piece of wire is connected to one terminal of a dry cell, and tapped on the other terminal, a very slight spark may be seen in a darkened room. If a coil of many turns of wire is included in series with this cell, the same process of tapping will show brilliant sparks, particularly if the coil has an iron core. The explanation of this lies in the fact that the cell voltage of about 1.5 is too feeble to cause much of a spark. However, when the large inductance is included in the circuit, there is a large number of linkings between wire turns and flux lines. If these flux lines collapse suddenly, as they do when the circuit is broken, there will be a large change in the number of linkings taking place in a very small interval of time. From equation (51), this means that a large voltage will be set up. This principle is made use of in ignition apparatus and spark coils of various types. According to Lenz's law, the induced emf. will be in such a direction as to oppose the change which causes it. In this case, when the circuit is broken, the change is from some value of current I to zero. Therefore the induced emf. will be in the same direction as the original current, and will try to keep the current flowing. On the other hand, when a battery is being connected to an inductive circuit by means of a switch, the rising current will establish a set of magnetic flux lines which will, as they grow, induce an emf. which tends to keep the current from rising.

47. **Mutual Inductance.**—Consider a circuit AA , Fig. 70, with a current I flowing through it. The magnetic flux through A is directly proportional to I , and that part of the total flux which interlinks with a near-by coil B is also proportional to I . This means that the total number of interlinkings N , between flux lines that arise in the A circuit, and wire turns of the B circuit, is proportional to the current I in the circuit A . This fact may be represented by the equation

$$N = MI \tag{53}$$

where M is the constant of proportionality. This factor M is called the "mutual inductance" of the two circuits. When

currents are started, stopped, or varied in coil *A*, the mutual inductance shows itself by an emf. induced in coil *B*. The induced emf. may be calculated by

$$E = M \frac{I'}{t} \quad (54)$$

where *I'* is the amount by which the current in the *A* circuit varies in the time *t*. Mutual inductance is necessarily measured in the same units as self-inductance. It causes a transfer of electrical energy between two circuits which have no electrical conducting path between them.

The mutual inductance of two given circuits depends on the size and construction of the circuits themselves, their distance apart, their relative positions in space, and the nature of the material between them. All of these factors necessarily affect the magnetic flux interlinked with both circuits. The mutual inductance falls off rapidly as the distance between the two circuits is increased. When two solenoids have their axes in the same straight line their mutual inductance is the largest for that spacing, while if the axes of the solenoids are at right angles their mutual inductance is much smaller. If the axes are parallel but not in the same straight line, the mutual inductance will also be somewhat smaller than if they were in the same straight line. In Fig. 70 the two loops of wire have their axes in the same straight line and are very close together, and hence their mutual inductance is a maximum. If there is iron between the coils, it has a shielding effect and reduces the magnetic flux linked with both circuits, and hence reduces the mutual inductance.

Two or more coils intended to be used as self-inductances are often connected into the same circuit. In such cases the fact must be taken into consideration that the various coils have mutual inductances also, and if accurate values of inductance must be used the various coils should be so placed that their mutual inductances are so small as to be negligible, or the mutual inductances should be taken into account. If other circuits are in operation near by, it is also important that their mutual inductances receive consideration.

A familiar example of the effect of mutual inductance is the "cross talk" often experienced between telephone lines which

run parallel on the same poles, or the "inductive disturbances" experienced on a telephone line which runs adjacent to an electric-power line.

Mutual inductance is of particular importance in radio circuits. The phenomena of mutual inductance are the essential principles involved in the operation of many different types of electrical apparatus, of which some are considered in the following pages.

For further information regarding self-inductance and mutual inductance, the reader may consult Bureau of Standards Circular No. 74.

48. **Energy Relations in Inductive Circuits.**—In mechanics it is well known that a piece of matter cannot set itself in motion and that energy must be supplied from outside. So in the electric circuit a current cannot set itself in motion, and energy must be supplied by some form of generator (source of emf.). It has already been explained how a magnetic field arises about electric circuits. When this field collapses or disappears, the energy stored in the field is returned to the circuit. It can be shown that the energy thus associated with a magnetic field is given by the equation

$$W = \frac{1}{2}LI^2 \quad (55)$$

where I is the value of the current and L is the self inductance. The student who is familiar with the laws of mechanics will note that this equation is quite similar to that for kinetic energy of a moving body

$$\text{Kinetic energy} = \frac{1}{2}ms^2$$

where m is the mass of the body and s is its speed.

Illustration of Inductance.—When a nail is forced into a piece of wood the mere weight of the hammer as it rests on the head of the nail will produce but little effect. However, by raising the hammer and letting it acquire considerable speed, the kinetic energy stored is large, and when the motion of the hammer is stopped this energy is used in forcing the nail into the wood. In the electric circuit a cell with its small emf. can cause only a feeble spark. By including a piece of wire with many turns in the circuit, however, energy is stored as shown in equation (55). A small current will enable a large amount of energy to be stored in the magnetic field, if L is large. Then

when the circuit is broken and the field collapses, this large amount of energy is released suddenly, and a hot spark of considerable length is the result.

The close relations between capacity, inductance, and resistance will be more fully discussed in Chapter 3.

I. Alternating Current.

49. **Reactance.**—A steady current in a circuit meets no other hindrance than the resistance of the circuit. If the current changes, this is no longer true. If the circuit has inductance, the current is opposed by the emf. induced by the variation of the current. (See Sec. 46.) If a condenser is present, this is constantly charging or discharging as the current changes, and it exerts a controlling influence on the passage of the current. If both inductance and capacity are included in the circuit, they tend to offset each other in their effects, but usually one or the other exerts a predominating influence, with the result that there is added to the resistance an extra opposition to the current, which is known as the "reactance."

The more rapid the changes of the current the greater the induced emf. in a circuit and consequently the greater the inductive reactance. On the contrary, the reactance of a condenser is less, the more rapidly the current varies, as can be understood when we reflect that the greater the number of charges and discharges of the condenser performed each second the greater the total quantity of electricity which flows around the circuit in that interval—that is, the greater the current. In general, the reactance of a radio circuit is very much greater than the resistance.

To calculate the current in a radio circuit, then, it is necessary to know how to calculate the reactance and how to combine it with the resistance, in order to determine the total hindrance or "impedance" to the current. Since the reactance, however, depends upon the way in which the current is varying, it is evident that this must be definitely specified in each case. The problem can not be solved for all imaginable kinds of variation of the current. Radio currents, however, belong to the general class of alternating currents, and for these the theory is rather simple. In the following sections is given a brief treatment, not of general alternating current theory, but

merely of those alternating current principles which are essential to an understanding of the actions in radio circuits.

50. Nature of an Alternating Current.—An alternating current is one in which electricity flows around the circuit, first in one direction and then in the opposite direction, the maximum value of the current in one direction being equal to the maximum value in the other. All the changes of current occur over and over again at perfectly regular intervals.

Sine Wave.—To get an insight into the nature of such a current, suppose a case where the alternations occur so slowly that we may follow the changes of current with an ammeter. In the table below are given values of the so-called “sine-wave current” at successive equal intervals of time. The maximum value is taken as 10 amperes.

Time (sec.).	Current (amp.).	Time (sec.).	Current (amp.).	Time (sec.).	Current (amp.).
0	0	13	— 2.59	25	2.59
1	2.59	14	— 5.00	26	5.00
2	5.00	15	— 7.07	27	7.07
3	7.07	16	— 8.66	28	8.66
4	8.66	17	— 9.66	29	9.66
5	9.66	18	—10.00	30	10.00
6	10.00	19	— 9.66	31	9.66
7	9.66	20	— 8.66	32	8.66
8	8.66	21	— 7.07	33	7.07
9	7.07	22	— 5.00	34	5.00
10	5.00	23	— 2.59	35	2.59
11	2.59	24	0	36	0
12	0				

The ammeter in such a case would creep slowly up to a maximum indication of 10 amperes, return gradually to zero, reverse its direction and build up to a value of 10 amperes in the opposite direction, then decrease to zero again, build up again in the original direction, and so on. It is, of course, to be understood that the current assumes in turn all possible values between zero and the maximum value (10 amperes in this case), and that the current has the same value throughout the circuit at every moment. The current in this case, as well as that of a steady current, may be regarded as like the flow of an incompressible fluid. The emf. is, however, to be regarded here as a variable electric pressure, which acts first in one direction and then in the other.

The values of current in the preceding table are plotted in Fig. 71 as ordinates (vertically), and the corresponding lengths of time elapsed since the start, as abscissas (horizontally), and a smooth curve drawn through the points enables one to determine what is the value of the current for any moment lying between any two of those which are included in the table. It is to be noted that the changes of current repeat themselves. Thus in the table the current is the same at 1 sec. and 25 sec. after the start; at 7 sec. and 31 sec., etc. The interval of 24 seconds in this example is the "period" of this alternating current. The current passes through a complete "cycle" of changes in one period.

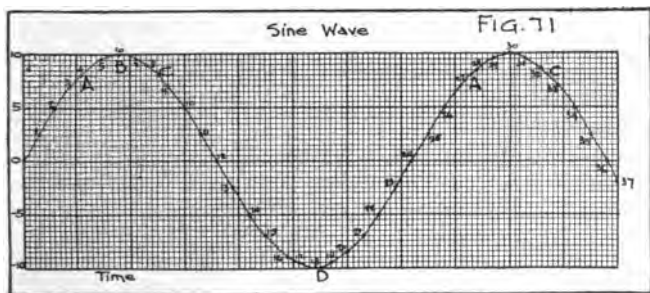

A current like that just treated is the same as that which would be produced in a circuit attached to a coil revolving very slowly in a uniform magnetic field. (See Chap. 2, Sec. 74.) The motion has been assumed slow in order that the changes can be followed with ordinary direct-current instruments. In order to represent the current developed by an ordinary low-frequency alternating-current generator, we must, however, imagine the coil to revolve more than a thousand times more rapidly. Thus the usual a. c. lighting circuits carry currents whose period is only about $\frac{1}{60}$ second. The current passes through complete cycles each second, that is, its "frequency" is 60 cycles per second. Ordinary alternating-current generators can not use magnetic fields which are entirely uniform, so that the current obtained never passes through its changes in exactly the same way as the ideal sine current pictured in

Fig. 71. The difference is, however, usually so small in well-designed machines that it does not need to be taken into account.

The frequency of radio currents is enormously greater than the usual low-frequency alternating currents. In order that Fig. 71 may properly represent a radio current, we must suppose a whole cycle to be completed in, say, $\frac{1}{1000000}$ to $\frac{1}{10000000}$ second.

51. Average and Effective Values of Alternating Current.—In just the same way as we have analyzed alternating current by imagining it to change slowly, it is possible to get an insight into complicated movements, like the throwing of a ball or the galloping of a horse, by running a motion-picture film of the action so slowly that the separate pictures on the film can be examined one at a time.

When a direct-current ammeter is traversed by an ordinary alternating current, the changes of current are altogether too rapid to be followed by the needle of the instrument. It can only take up an average position corresponding to the average of all the values through which the current passes during a cycle. However, since the current passes through the same values in one direction that it does in the other, the average value during the cycle must be zero. That this is the case can be shown by connecting a direct-current ammeter into an alternating-current circuit. The ammeter needle stands still at zero or else merely presents a blurred appearance while standing at zero. The same remarks apply to the use of a d. c. voltmeter in an a. c. circuit.

A. C. Voltmeters and Ammeters Indicate Effective Values.—Alternating-current voltmeters and ammeters may be of several different types (hot wire, dynamometer or electrostatic, see Sec. 60), all of which, however, give a deflection in the same direction, whichever the direction of the current. The force on the moving portion of such an instrument is at every moment proportional to the square of the current through the instrument. When an alternating current passes, the average deflection taken up by the pointer is therefore proportional to the average of the squares of all the values of current during the cycle. For a true sine current, the average of the squares of all the values of current during the cycle can be shown to have a value of one-half the square of the maximum value.

Equivalent Direct Current.—The heating effect of a current is, at every moment, proportional to the square of its value at that moment. The average heating effect of an alternating current must, therefore, be proportional to the average of the squares of all the values of the current during the cycle, or must be proportional to one-half the square of the maximum current. The same heating effect would, of course, be produced by a steady current, whose square is equal to the average of the squares of the alternating current taken over the whole cycle. That is, the “effective current” is equal to the value of the direct current which would produce the same heating effect in the circuit in question. Since its square is equal to one-half the square of the maximum value, the effective value of the current is

$$I = \sqrt{\frac{(\text{maximum})^2}{2}} \quad (56)$$

or equal to the maximum value divided by $\sqrt{2}$. This is the same as the maximum value multiplied by 0.707.

The effective current in the table above is 7.07 amperes, and this would be the current indicated by an a.c. ammeter in the circuit, although the current varies between 10 amperes in one direction and 10 in the other. The same heating effect would result if a direct current of 7.07 amperes were sent through the circuit. Likewise, an a.c. voltmeter will always read the effective value of the voltage, which is equal to the maximum voltage multiplied by 0.707.

52. Circuit with Resistance Only.—Let us imagine a circuit with resistance R ohms, and with such small inductance and capacity that they may be neglected. Let us suppose, further, that sine wave alternating emf. is applied to the circuit. At every moment, the current will be found by dividing the emf. at that instant by the resistance of the circuit. The current is zero at those moments when the emf. is also zero, and is a maximum when the emf. is a maximum. In fact, the changes of current keep step with those of emf. The current and emf. are said to be “in phase” or to have “zero phase angle.” Since the effective values of emf. and current are each the same fraction of their respective maximum values, the effective

current I will be calculated from the effective emf. E by the relation

$$I = \frac{E}{R} \quad (57)$$

That is, in this special case, Ohm's law holds, even when the current is alternating. An ordinary incandescent lamp circuit approximates this ideal circuit.

The power in the circuit is, at every moment, equal to the product of the values of current and emf. which hold at that moment. The average power taken over the whole cycle is equal to the product of the effective current by the effective emf., that is, average $P = IE$. The power is used up in the circuit entirely in heating the resistance R .

53. Phase and Phase Angle.—The values of current given in the table above are those which hold for certain definite moments in the cycle of change of the current. Each time the cycle is repeated the same values are run through, and any chosen value will be reached at a perfectly definite fraction of the way through the cycle. Each maximum in the positive direction, for example, occurs just one-quarter of a cycle after the preceding zero value. The points A in Fig. 71 have the same phase, although each is in a different cycle from the others. The current has the same value at the points C as at A , but points C are not in the same phase as A , since at A the current is increasing, and at C it is decreasing.

The phase is, then, a certain aspect or appearance, occurring at the same definite part of each succeeding cycle. Difference in phase is nothing more than difference in position in the cycle. It is best referred to as difference in time, expressed as the fraction of the length of a cycle. Thus, the difference of phase of points B and O , Fig. 71, is one-quarter of a cycle; that of points B and D one-half cycle, etc. It is also customary to express difference in phase as an angle. A difference of phase of one complete cycle is regarded as equivalent to the angle of a whole revolution or circumference, that is, to 360° . One-quarter cycle is accordingly 90° , and two points with a difference of phase of one-quarter cycle are said to have a difference of phase of 90° , etc.

The idea of phase angle is useful when two emfs. are acting in the same circuit or when the current and the emf. which pro-

duces it do not pass through their maxima at the same moment. Fig. 72 shows the waves of emf. and current in a circuit where the emf. and current differ in phase by about one-eighth of a cycle; i. e., they have a phase angle of about 45° .

When a circuit has resistance but no inductance or capacity, the emf. and current are in phase or the phase angle is zero. Their waves, shown in Fig. 73, pass through zero at the same

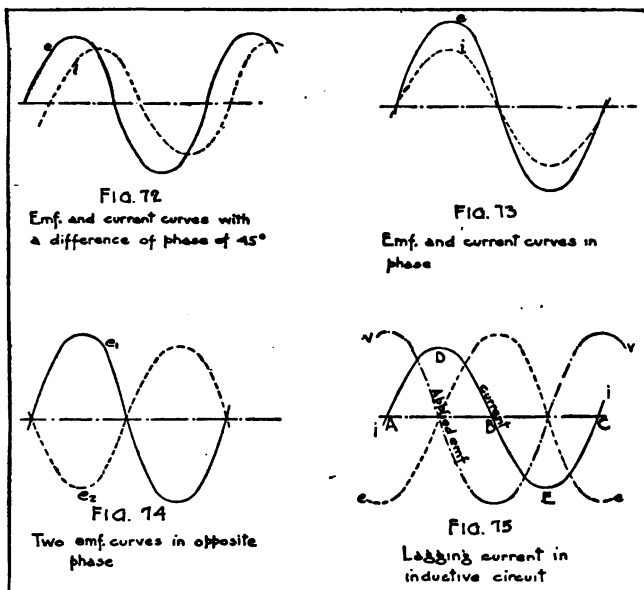

moments and reach their maximum values at the same moments. The case of opposite phase shown in Fig. 74, in which two emfs. are represented, is such that, although they pass through their zero values at the same moments, at other times one is always acting in the opposite direction to the other. Their phase angle is 180° .

In any series circuit where the reactance is not zero the applied emf. and the current have a difference of phase.

54. Alternating Current in a Circuit Containing Inductance Only.—Such a circuit would be approximately represented by

one with a large inductance coil wound with such large wire that only a very small resistance would be offered to the current.

If an alternating emf. is applied to the circuit, an alternating current flows, and the changes of the current induce an emf. in the circuit which is greater, the greater the inductance and the more rapidly the current changes; that is, the greater the frequency of the current.

The current i changes most rapidly at the points A , B , and C , Fig. 75, where it is passing through zero value. The induced emf. must therefore be a maximum at those points. Since it always opposes the change of current, it must be at its maximum negative value in the figure at the points of the axis, A and C , and at its positive maximum at point B . At points D and E , the current does not change for a moment, so that the induced emf. must be zero at those times. It is not difficult to show that when we have a sine alternating current there is also a sine alternating emf. induced as shown in curve e , Fig. 75.

In this kind of a circuit, this induced emf. has to be overcome at each moment, but the applied emf. is not requisitioned for any other service. Accordingly, the applied and induced emfs. are at every moment equal and opposite. The applied emf. wave is therefore given by curve v , Fig. 75, drawn with its vertical heights just equal and opposite to those of curve e . It is evident that the current lags one-quarter of a cycle in its changes behind those of the applied emf. The current is said, therefore, to lag 90° in phase behind the applied emf.

The effective value of the induced emf. can be shown to have the value $2\pi fLI$, in which f is the frequency, L the inductance in henries, I the effective value of the current in amperes, and $\pi=3.1416$, or nearly $3\frac{1}{2}$. An effective applied emf. E , therefore, will produce a current whose effective value is

$$I = \frac{E}{2\pi fL} \quad (58)$$

Inductive Reactance.—The quantity $X=2\pi fL$ is known as the reactance of the inductance coil. It is larger the greater the frequency and the greater the inductance, as would be expected, and has a considerable value in many cases. The reactance is measured in ohms. As an example, suppose a coil of 0.1 henry

at 100,000 cycles per sec. The reactance is $X=6.283 \times 100,000 \times 0.1=62,830$ ohms. That is, such a circuit throttles down the current as much as a resistance of 62,830 ohms would do. There is this difference, however, between the effects of an inductance and a resistance, that no energy is dissipated in heat in an inductance. In one-half of the cycle, energy is taken from the circuit, it is true, but this is stored up in the magnetic field around the coil, and in the next half cycle the magnetic field collapses on the coil and gives the energy back to the circuit. Thus in the long run energy is neither gained nor lost in the circuit.

It is general practice to use the symbol ω to represent the quantity of $2\pi f$, since the quantity $2\pi f$ very frequently occurs in problems involving alternating currents. (See Circular 74, page 22.) Using this abbreviation, equation (58) may be written

$$I = \frac{E}{\omega L}$$

55. Circuit Containing Inductance and Resistance in Series.—

It is, of course, impossible to arrange a circuit which has absolutely no resistance. In addition to overcoming the induced emf., a portion of the applied emf. has to be employed to force the current through the resistance of the circuit. Thus if the current at any moment is passing through the value i , the emf. necessary to force the current through the resistance is Ri , and that which is overcoming the induced emf. is Xi , so that the value e which the applied emf. has at that moment is $e=Ri+Xi$. This equation shows the simple and obvious connection between the value of the current at any instant and the corresponding instantaneous value of the emf. which is producing it. However, it cannot be used to calculate the effective current from the effective applied voltage, for the reason that the two emfs. Ri and Xi are not in phase. When the former is passing through zero value the latter is at its maximum, and vice versa, so that the sum of the two emfs. has a maximum value less than the sum of their individual maximum values.

This is in line with the results of the following experiment: Let a coil of inductance L be joined in series with a resistance R , and let three voltmeters a , b , and c be applied, as shown, Fig. 76, to measure the emf. between the points A and B , B and

C , and A and C . The voltages measured by the voltmeters are effective values, and it is found that the reading of c is not equal to the sum of the readings of a and b , as would be the case with a direct current.

The voltmeter a gives the emf. RI and the voltmeter b the emf. XI , where I is the effective value of the current, which would be measured by an a. c. ammeter in the circuit. Analysis shows that the reading E of the voltmeter c is represented by the hypotenuse of the right triangle whose sides are RI and XI . See Fig. 77-a.

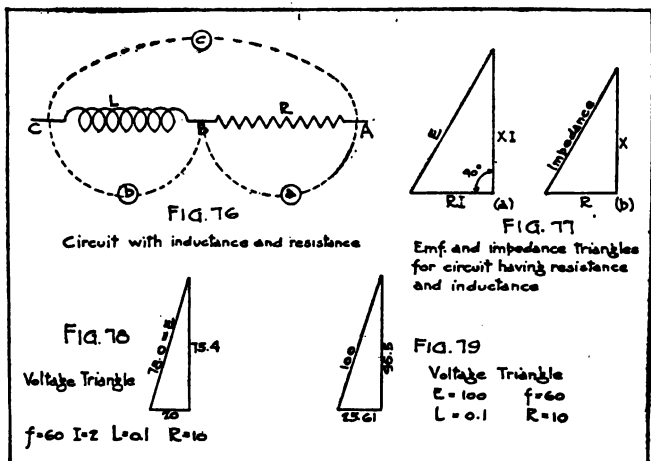

The effective applied emf. E in such a case is therefore related to the voltages RI and XI by the equation (relation between sides and hypotenuse of a right triangle),

$$E^2 = (RI)^2 + (XI)^2 = I^2(X^2 + R^2) \quad (59)$$

Accordingly the effective value of the current produced by the effective applied emf. E is

$$I = \frac{E}{\sqrt{X^2 + R^2}} \quad (60)$$

Impedance.—The quantity $\sqrt{X^2 + R^2}$ is known as the “impedance” of the circuit. It takes the place in alternating-cur-

rent theory of the resistance in Ohm's law. It is related to the resistance and reactance as the sides of the right triangle, Fig. 77-b.

As an example, suppose in Fig. 78 that $L=0.1$ henry, $R=10$ ohms, $f=60$ cycles per second. Find what applied emf. is necessary to cause an effective current of 2 amperes to flow.

$$RI=20 \text{ volts}$$

$$X = 6.283 \times 60 \times 0.1 = 37.7 \text{ ohms}$$

$$XI=75.4 \text{ volts.}$$

The applied emf. must therefore be by (59)

$$E = \sqrt{(20)^2 + (75.4)^2} = 78.0 \text{ volts.}$$

The reverse problem is to find what current will flow in the circuit when a given emf., say 100 volts, is applied. The impedance is $\sqrt{R^2 + X^2} = \sqrt{(10)^2 + (37.7)^2} = 39$ ohms.

Therefore the current will be $\frac{100}{39.0} = 2.56$ amperes. The emf. on the resistance is $2.56 \times 10 = 25.6$ volts and that on the reactance $2.56 \times 37.7 = 96.5$ volts, so that the voltage triangle is that given in Fig. 79.

Power Factor.—The power dissipated in heat in this circuit is of course $I^2R = (2.56)^2 \times 10 = 65.5$ watts. The product of the effective current and effective voltage is $100 \times 2.56 = 256$ "volt-amperes." To obtain the dissipated power from this product, it is therefore necessary to multiply by $\frac{65.5}{256} = 0.256$. Note that

this is the same as $\frac{10 \text{ ohms}}{39 \text{ ohms}}$. The number which it is necessary to multiply into the product of volts and amperes in order to get the power is called the "power factor." The power factor of the above circuit is 0.256. A circuit with resistance only and no inductance or capacity has a power factor of 1. A resonant circuit (see Chap. 3) is another example of power factor equal to 1. The power factor in other cases always lies between zero and one. The power in any circuit is calculated, then, by the formula

$$P = EIF \tag{61}$$

the power factor being given by the general formula

$$F = \frac{\text{resistance}}{\text{impedance}} \tag{62}$$

56. Charging of a Condenser in an Alternating Current Circuit.—A steady emf. is not able to pass a steady current through

a condenser. When the circuit is first closed, a charging current flows into the condenser, until the voltage between the plates of the latter has risen to the same value as the applied voltage. If the voltage is removed and the circuit completed by a wire, a discharge current flows out of the condenser in the opposite direction to the charging current. The discharge ceases when the plates of the condenser have no potential difference. (See Sec. 30.)

With an alternating emf. in the condenser circuit, an alternating current is constantly flowing into and out of the condenser to keep the voltage between the plates equal to the

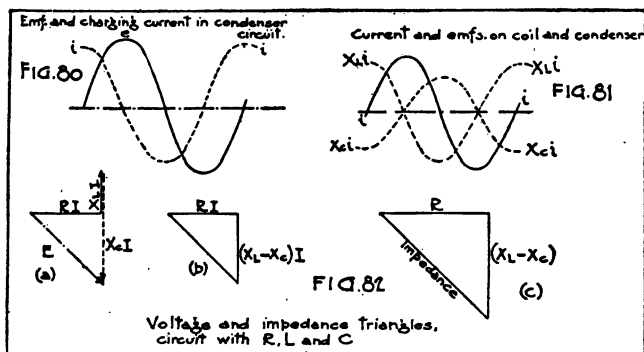

instantaneous value of the applied emf. The current is largest at those moments when the applied emf. is changing most rapidly; it is zero at the moments when the emf. is for a moment stationary at its maximum values. If curve *e*, Fig. 80, represents a sine alternating emf., it can be shown that the charging current curve will be like curve *i*; that is, the charging current is 90° "ahead" of the applied emf. in phase. (Contrast this with the relations in the inductive circuit.) The charging current will, in general, be greater the greater the capacity *C*, and the greater the frequency of the emf.

Reactance of Condenser.—Analysis shows that the effective value *I* of the charging current is $I=2\pi fCE$. The reactance of the condenser is accordingly

$$X = \frac{E}{I} = \frac{1}{2\pi fC} \quad (63)$$

where C is the capacity in farads. This shows that the reactance of the condenser is greater, the smaller the capacity and the lower the frequency. (Contrast with the reactance of an inductance.) The reactance, as before, is measured in ohms.

As an example, we find that the reactance of a condenser of 0.1 microfarad at 60 cycles is

$$\frac{10^6}{6.283 \times 60 \times 0.1} = 26,500 \text{ ohms.}$$

At 100,000 cycles, the reactance is only 15.9 ohms. From this it appears that the condenser offers much less obstruction to flow of current at high frequency than at low frequency, and hence, that a given alternating emf. causes a much larger current flow if the alternations are rapid than if they are slow.

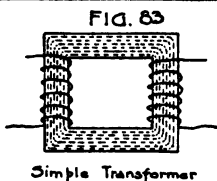
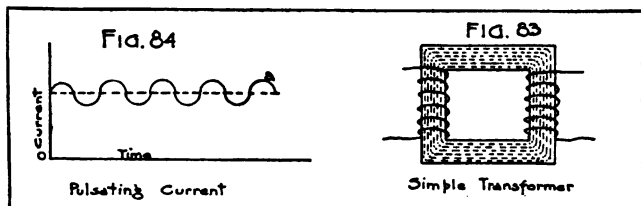

No energy is dissipated in a perfect condenser. Energy is stored in the dielectric of the condenser while it is being charged, but this is all restored to the circuit when the condenser discharges. Actually, no condenser is perfect, although well designed air condensers may be regarded as essentially so. Heat is always dissipated to a measurable extent in condensers with solid dielectrics. The condenser acts as though a certain resistance were joined in series with it. The actual value of this assumed series resistance depends upon the capacity and the frequency, as well as upon the nature of the dielectric. It is less, the greater the capacity, and in general inversely proportional to the frequency.

57. **Circuit Containing Capacity, Inductance, and Resistance in Series.**—When an inductance and capacity are joined in series and subjected to an alternating emf., the current through them both is the same, and the emf. on the condenser is $X_C i$ and that on the inductance $X_L i$, where the instantaneous current

has the value i , X_L is the reactance of the coil and X_C the reactance of the condenser. The curves for these voltages may be derived by combining the curves of Figs. 75 and 80. The curves $X_L i$ and $X_C i$, Fig. 81, show that at every moment the voltage on the condenser opposes that on the inductance. The circuit acts as though it possessed a single reactance equal to the difference of the reactance of the coil and the reactance of the condenser. If the latter is the larger the circuit behaves like a condenser circuit, and if the coil has the greater reactance, the circuit behaves like an inductive circuit.

The effective values of the voltages in the circuit are shown in Figs. 82-a and b. The impedance is found by combining the resistance and the resulting impedance in the triangle diagram of Fig. 82-c. The value of the impedance is evidently

$$Z = \sqrt{R^2 + (X_L - X_C)^2} \quad (64)$$

58. The Alternating Current Transformer.—A very important application of the principle of mutual inductance is the alternating-current transformer. The transformer is a particular kind of device for securing mutual inductance between two circuits. In most cases, the purpose of using the transformer is to change or *transform* alternating current of low voltage and comparatively large current to alternating current of higher voltage and smaller current, or vice versa.

A transformer used to deliver an output of higher voltage than the input is called a "step-up" transformer. A transformer used to deliver an output of lower voltage than the input is called a "step-down" transformer.

The fact that a. c. voltages can be easily stepped up or stepped down by the use of a transformer, while a change from a low d. c. voltage to a high d. c. voltage requires rotating machinery which is much more expensive (see Motor Generators, Sec. 102, p. 223), constitutes one of the great advantages of alternating current over direct current for the electrical transmission of power. The use of d. c. voltages even as high as 10,000 volts is unusual, and involves many difficulties. A. c. voltages exceeding 100,000 volts are in regular use on long transmission lines. The electrical transmission of power over anything but comparatively short distances would, in fact, be practically impossible without the use of alternating currents and the trans-

former. In Chapter 2 there are discussed various types of dynamo-electric machinery for generating electric currents, both d. c. and a. c. There are many practical operating conditions which limit the voltage which can be generated by a machine designed for generating either a. c. or d. c. For a given transmission line transmitting a certain amount of electrical power, the electrical power loss in the line is, of course, proportional to the square of the current, and, therefore, in general, inversely proportional to the square of the voltage of transmission. Thus, in transmitting 10,000 kw. at 500 volts the line loss will be about 100 times the line loss in transmitting 10,000 kw. at 5,000 volts. The use of high voltages for transmission is therefore very important. The great increase in efficiency of transmission at high voltages much more than compensates for the difficulties in insulation.

Construction.—An alternating-current transformer consists of two coils of wire so placed as to have appreciable mutual inductance. In nearly all transformers in use for the electrical transmission of power, as on electric lighting lines, the wire for both coils is insulated, and there is additional insulation between the two coils. In most cases the coils are wound so that they have a common iron core, which greatly increases their mutual inductance. The iron core is not a solid piece of iron, but is composed of thin sheets or laminations. The winding or coil to which the input power is delivered is called the “primary” and the winding which delivers the output to the load circuit is called the “secondary.” A simple transformer is shown in Fig. 83, in which the path of the magnetic flux is entirely through iron. This is called a “closed-core” transformer. A closed-core transformer of a type used in radio apparatus is shown in Fig. 181, page 355. In some transformers the path of the magnetic flux is partly through air; such a transformer is called an “open-core” transformer. The induction coil, which has various applications outside of radio communication, such as in the ignition system of automobiles, is a particular kind of open-core transformer. An induction coil is shown in Fig. 188, page 363. In some transformers there may be no iron core; these are called “air-core” transformers. Air cores are often used for transformers for high frequencies, such as the frequencies employed in radio communication. The mutual

inductance of the windings of an air-core transformer is necessarily comparatively small. At low frequencies only small amounts of power can be conveyed from one circuit to another by air-core transformers.

It can be shown that if I_1 is the effective value of the current in the primary, M the mutual inductance, and f the frequency, the effective value of the emf induced in the secondary will be $2\pi fMI_1$.

In Section 119, page 267, the use of "coupled circuits" in radio communication, and various kinds of "coupling," including "inductive coupling," are discussed. The transformer is a device for obtaining such "inductive coupling."

Operation.—Assume that the primary is connected to a source of a. c. supply, and that the terminals of the secondary are not connected. The primary winding with its iron core is then simply an inductance coil of high inductance which offers a very large impedance to the voltage applied to the primary. A certain small current will flow in the primary, which is the "no load" or "open circuit" current, and is also sometimes called the "magnetizing current." The magnetic flux in the iron core must be of such a value that during a second the number of changes in flux linkages at the applied frequency is sufficient to induce in the primary winding a back electromotive force practically equal in magnitude to the applied voltage.

Assume now that a load is connected to the secondary terminals. A current will flow in the secondary circuit due to the emf induced in the secondary winding. The current will at each instant flow in the secondary winding in such a direction as to tend to cause a magnetic flux in the core in a direction opposite to the direction of the flux caused by the current now flowing in the primary winding. As long as the voltage applied to the primary is maintained constant, the flux actually existing in the iron core must be of sufficient magnitude to induce in the primary winding a back emf substantially the same as the applied voltage; that is, the effective value of the flux over a cycle must remain substantially constant under the varying conditions of load. In order to maintain the flux constant, the current flowing in the primary winding must increase to a value such that the increase in the primary ampere-turns is sufficient to overcome the opposing magnetic effect of

the secondary ampere-turns. Considering the primary winding by itself, the effect is as though the iron had suddenly become less permeable. That is, the effective inductance of the primary winding, considered by itself, drops to a value sufficient to permit enough primary current to flow to maintain the flux substantially constant. When the secondary is delivering the full current for which the transformer is rated, the effective inductance of the primary becomes quite small.

When the usual type of transformer for commercial frequencies is delivering its rated load, the primary current is 10 to 50 times the small current taken by the primary when the secondary is not connected. As has been stated the magnetic effect of this primary current flowing when the transformer is under load is almost entirely counteracted by the opposing magnetic effect of the secondary current.

Occasionally the secondary may be practically short-circuited, perhaps by accident, and in such cases the primary winding may be called on to carry a large current for a short time. Such short circuits not only make severe demands on the electrical system but produce large mechanical forces acting on the windings themselves, tending to move the coils with respect to each other.

If n_1 represents the number of turns in the primary winding, and n_2 the number of turns in the secondary winding, and I_1 represents the increase in the primary current due to a current I_2 flowing in the secondary, then with a constant voltage applied to the primary:

$$n_1 I_1 = n_2 I_2$$

or

$$\frac{n_1}{n_2} = \frac{I_2}{I_1}$$

If E_1 represents the emf induced in the primary, and E_2 represents the emf induced in the secondary,

$$\frac{n_1}{n_2} = \frac{E_1}{E_2}$$

Thus if the primary has 100 turns and the secondary 1,000 turns, and an emf of 200 volts is applied to the former, an emf of 2,000 volts will be induced in the latter, and if the primary current is 50 amperes the secondary current will be 5 amperes.

Leakage.—All of the magnetic flux due to the current flowing in one winding and linked with that winding is not also linked with the other winding. The path of a certain part of the flux is through the air, outside of the core. This part of the flux due to one winding which is not linked with the other winding is called its "leakage" flux. In well-designed transformers this leakage flux is quite small. The leakage flux obviously is not effective in transferring energy from one winding to the other. Leakage may be reduced by offering to the magnetic flux a complete path of high permeability. One way to do this is to use a closed core, so that the path of the magnetic flux is entirely through iron; in the open-core transformer part of the path of the magnetic flux is through air, and considerable leakage necessarily results. Another way is to use a core of large cross section, so that the iron is worked at low flux densities. Leakage is also reduced by bringing the coils close together and making them approach coincidence. This may be done by winding one winding right on top of the other; very little magnetic flux can then be linked with one winding and not with the other.

Losses.—The transformer is one of the most efficient kinds of electrical apparatus. The efficiency of well-designed transformers is usually from about 94 to 98 per cent, according to size, the larger units being the more efficient. There are "copper" losses in primary and secondary windings, equal to the resistance times the square of the current. There are "eddy current" losses due to the currents induced in the iron core. If the iron core were solid, currents would be set up in the whole cross section of the core in the same plane as the plane of a turn of winding. By using thin sheets of iron the path of the eddy currents is reduced, and hence the eddy-current loss. At comparatively low frequencies the eddy-current loss is proportional to the square of the frequency and also to the square of the thickness of the sheets or laminations. At radio frequencies other effects must be taken into consideration, and these relations do not hold. (See the papers referred to at the end of this section.) At high frequencies it is important to have the laminations as thin as possible. In transformers for commercial frequencies the thickness of the laminations is

usually between 0.010 inch and 0.030 inch. If a solid core were used in a transformer for handling any considerable amount of power, enough heat might be quickly evolved by the eddy currents in the core to destroy the unit. There is also another loss in the iron, called the "hysteresis" loss. Hysteresis losses are caused by reversals of the magnetism of the core and represent the energy required to change the positions of the molecules of the iron core. At comparatively low frequencies hysteresis losses are directly proportional to the frequency and are greater the higher the flux density at which the iron is worked. Hysteresis losses at radio frequencies are discussed in the papers mentioned at the close of this section. The sum of the eddy-current losses and the hysteresis losses is known as the "core losses" or "iron losses." The core losses occur as long as a voltage is applied to the primary and are nearly the same whether the secondary is delivering a load current or not. The current taken by the primary when the secondary circuit is open supplies these losses in the iron. It is therefore very important to design transformers so that the eddy-current losses and hysteresis losses are small. This is particularly important in transformers which are connected to the line all the time but supply a load during only a small part of the day, as transformers on electric-light systems, and is less important on transformers supplying full load secondary current all day, as transformers in a power house. These losses are discussed further in connection with dynamo-electric machinery in Section 78, page 172.

The cores of most transformers and other apparatus for alternating currents are now made of silicon steel instead of soft iron or a mild steel. One advantage of silicon steel is that when subjected to heat it does not age appreciably; that is, its permeability does not decrease with use. Ordinary soft iron will age rapidly with heat. Therefore a transformer with core of silicon steel can be operated at a higher temperature than a transformer with soft-iron core. Another important advantage of silicon steel is that its ohmic resistivity for electric currents is much higher than soft iron, and therefore in a given transformer the eddy-current losses will be less with a silicon-steel core than with a soft-iron core. The permeability of silicon steel is about the same as the permeability of the soft iron

which has been used for transformers. Practically all core transformers used for radio apparatus, for either transmitting or receiving, have cores made of silicon steel.

Cooling.—The losses represent electrical energy converted into heat. Some means must be provided for dissipating this heat, or the temperature of the transformer may rise until it is destroyed. Small sizes, including most of those found in radio stations of moderate size, may be cooled by simply being exposed to the air. The exposed surface of the windings must be sufficient to dissipate the heat. In larger sizes an air blast may be blown through the transformer. Large transformers are also cooled by immersing the windings in oil, which is kept cool by circulation.

If a tap is brought out from an intermediate point of the winding of an inductance coil, a part of the voltage applied at the terminals may be tapped off between one terminal and the intermediate tap. This can be considered to be a transformer in which one winding serves as both primary and secondary. It is simple and cheap, but has the disadvantage that the two windings are not insulated and the voltage to ground of the high-voltage winding also exists in the low-voltage circuit. Its use is confined for the most part to small sizes. This device is often called an "auto-transformer."

For bell ringing and similar work in which low-voltage alternating currents can be used, use is now made of small transformers rated at only a few watts, which are connected to the a. c. electric supply and deliver about 10 volts at their secondary terminals.

In radio apparatus the load on the secondary of a transformer usually includes a capacity. It may become desirable to adjust the system consisting of the a. c. generator, transformer, and secondary condenser so that the impedance of the primary circuit is a minimum; that is, so that the condition of "resonance" exists. (See Sec. 109, page 234.) This arrangement is called a "resonance transformer," and is discussed in Bureau of Standards Circular 74, page 230. With such an arrangement it is possible to obtain very high voltages. One type of transformer employing resonant circuits is sometimes called a "Tesla coil" and may be made to produce spectacular high-voltage effects.

On closing the primary switch when a transformer is first connected to the line a relatively very large current may flow for an instant, its magnitude depending on the state of magnetization in which the iron was left when the transformer was last disconnected from the line. This momentary current obtained on closing the primary line switch may in some cases be perhaps 10 times the primary rated full-load current and may blow the fuses in the primary line.

Radio-frequency transformers.—Transformers used for alternating currents of radio frequencies usually have air cores; that is, no iron is employed, as has been stated. If an iron core is used, very thin laminations are employed. At radio frequencies, the effectiveness of iron in increasing the magnetic flux is not as great as at low frequencies, the eddy currents contributing to this effect.²⁵ (See also footnote, Sec. 42, p. 105.) Transformers for radio frequencies are shown in Figs. 197, 198, 199, pages 372–374. Small radio-frequency transformers are used in electron tube amplifiers. (See Sec. 196, p. 482.) Small transformers with iron cores, for frequencies up to perhaps 3,000, are also employed in electron tube amplifiers.

A common use of a transformer with radio frequencies is to obtain an alternating current from a pulsating current. For example, in the use of electron tubes for amplifying received signals, Section 196, page 479, pulsations are produced in the plate current, above and below its normal steady value. By passing the plate current through the primary of a transformer, an amplified alternating emf. is obtained in the secondary, and this emf. is applied to the grid circuit of a second electron tube, and so on. If curve *a*, Fig. 84, represents a pulsating current, the latter may evidently be regarded as compounded of a steady current (dotted line) and an alternating current. The steady current has no inducing effect in the transformer, but the alternating part induces an alternating emf. in the secondary circuit.

²⁵ Information regarding the magnetic properties of iron at radio frequencies may be found in the following papers in the "Proceedings of the Institute of Radio Engineers," C. Nusbaum, vol. 7, p. 15, Feb., 1919; M. Latour, vol. 7, p. 61, February, 1919; L. T. Willson, vol. 9, p. 56, February, 1921.

J. Measuring Instruments.

From what has gone before, it will be plain that the presence of an electric current can be known by such effects as the production of heat, magnetic action, or chemical changes. All of these effects are greater with a strong current than with a weak one, therefore all can be used to give an idea of the magnitude of a current. Instruments have been invented which take advantage of each of those effects, but some are more conveniently used than others. Those about which the student of radio particularly needs to know are based on two effects of the electric current; the magnetic effect and the heating effect.

Such instruments can be used either to indicate the current in amperes flowing in a circuit, in which case they are called ammeters, or to indicate the potential difference in volts between two points, in which case they are voltmeters.

59. Hot-Wire Instruments.—Currents of radio frequency are generally measured by means of instruments which depend on the heating of a wire or strip of metal. They are therefore called "thermal" ammeters. These are again divided into two main classes, the expansion and the thermocouple instruments. The first takes advantage of the lengthening of a metal wire or strip when it is heated. Fig. 85 illustrates the principle. The current to be measured flows along the wire *AB*, which is of a material having sufficient resistance to cause it to become hot. In heating, it stretches somewhat. That permits it to be pulled aside by the spring *S* acting through the thread *T*. The latter passes around the shaft *P*, and by turning it causes the pointer to move over the scale a greater or less distance, depending on the current in *AB*. The scale is graduated (marked off) in amperes so that the position of the pointer shows directly how large the current is.

The thermocouple type of ammeter¹⁶ utilizes the fact that when the junction of two dissimilar metals is heated, an emf. is developed (see Sec. 15). A pair of metals used for this purpose is called a "thermocouple." The value of the emf. depends on the combination of metals and ordinarily increases directly as the temperature is increased.

¹⁶ Such instruments are made by the Weston Electrical Instrument Co. and the Roller-Smith Co.

In Fig. 86, the thermocouple consists of the two wires c and d , and their junction is in contact with the hot wire AB , in which the radio-frequency current is flowing. The emf. produced by the heat at the junction is applied to G , an instrument of the type shown in Fig. 88 below, and causes a pointer to deflect; the millivoltmeter G responds to the direct current sent through it by the emf., as will be explained in the next section.

It is to be noted that the heat due to a given number of amperes of alternating current is the same as that of an equal number of amperes, direct current. In fact, the effective value

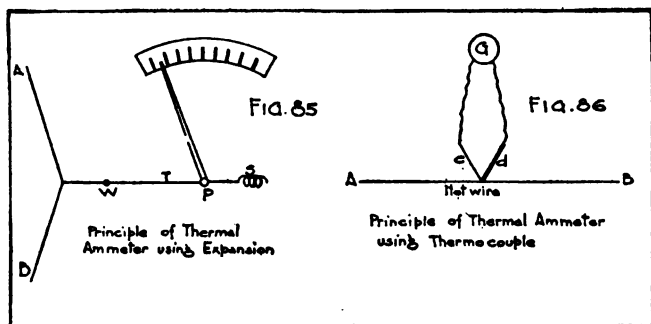

in amperes of an alternating current is defined as equal to the value in amperes of the direct current which will produce the same average heating effect in a given conductor under exactly similar conditions. (See Sec. 51.) The emf. produced at the junction does not depend on the direction of the current in AB but merely on the amount of heat produced. This emf. is always in the same direction; it can therefore be measured by a d.c. instrument. Thus the combination is useful for measuring high-frequency currents.

The heat developed varies as the square of the current, and the emf. of the thermocouple varies, quite closely, as the heat developed, so the indications of ammeters of the thermal type change, practically, as the square of the current. Consequently the scale is not uniform, being more open at the upper end than at the lower.

In Fig. 86 the thermocouple is made to appear separate from the rest of the instrument; in commercial ammeters the thermocouple and the indicating instrument are placed inside the same case, and the scale is made to read the amperes in the radio-frequency circuit.

When a hot-wire instrument is needed for currents of more than a few amperes, it is not practicable to build it with a single heating wire. This is true both for expansion and for the thermocouple type. Several hot wires or strips are therefore used, arranged cylindrically so that the radio currents divide equally among them. Then, either the effect on one of them alone is used to operate the indicating mechanism, or if thermocouples are used, the emfs. of several can be combined in series, so that their effects are added.

On some of the older radio equipments, instruments are found which are incorrectly called wattmeters. They are, as a matter of fact, simply ammeters in which the scale instead of being marked in amperes is marked proportionally to the square of the number of amperes. They are properly called "current-square meters."

60. Magnetic Instruments.—While the heating effect of the current is used for measurements at radio frequency, the magnetic effect is the one utilized in most instruments for direct current and for low-frequency alternating current. The simplest and most common instrument for measuring direct current depends upon the force between a permanent magnet and a wire carrying current.

D. C. Milliammeter.—Fig. 87 represents a rectangular coil *C* of fine insulated wire between the poles *NS* of a permanent magnet.¹⁷ The coil consists of a number of turns wound on a light metal frame, which is pivoted in jewel bearings somewhat like those of a watch. *SS* are spiral springs resembling the hairspring of a watch but somewhat heavier and made of material that is nonmagnetic and a better electrical conductor than steel. They serve the double purpose of conducting the current and controlling the position of the coil. *O* is a cylindrical piece of soft iron that serves as a good magnetic path between *N* and *S*, and causes a strong and uniform magnetic

¹⁷ Instruments with a movable coil in the field of a permanent magnet are called the "moving-coil" type.

field to exist in the spaces between *N* and *O* and between *O* and *S*.

Assume that *A* and *B* are connected to a source of emf., so that current flows as indicated by the arrows. In the portion of the coil next to the *N* pole of the magnet the current flows downward in each turn of wire. The direction of the magnetic field is always from *N* toward *S*. By the "left-hand rule"

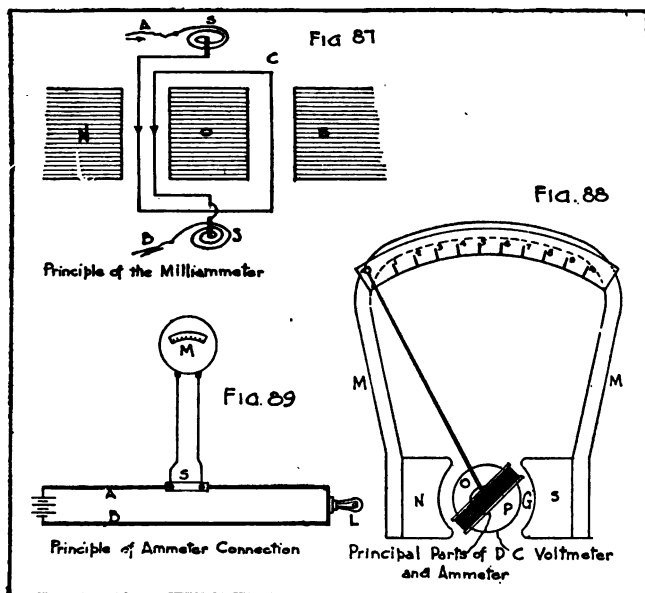

(Sec. 43), it is seen that the force on the wires is toward the front (out of the paper). On the side of the coil near the *S* pole the current is up; that side tends to be pushed toward the rear (into the paper). As a whole, therefore, the coil tends to turn on its pivots. This motion is opposed by the springs, and for each strength of current, there is some position of the coil in which the force due to the current and the force due to the springs balance. A pointer can therefore be attached to the coil so as to indicate, by its position over a scale, the current in amperes, in the coil. With the strong magnets, delicate

parts, and fine workmanship found in good instruments, it takes only a very small fraction of an ampere to move the pointer over its entire range; the scale may be graduated in thousandths of an ampere and the instrument used as a "milliammeter." Also, with certain modifications to be described presently, the instrument can be used to indicate millivolts, and is then called a "millivoltmeter."

The arrangement of the parts of such an instrument is shown in Fig. 88. Attached to the ends of the permanent magnet *MM* are the soft iron pole-pieces *NS*, and between them is the cylindrical soft iron core *O*, mounted on supports not shown in the sketch. This arrangement provides a strong and uniform magnetic field in the narrow gap *G*. The coil *C* is free to turn in this gap, which is wide enough merely to allow the necessary clearance. *P* is the upper spiral spring, above the top of the coil. The other one is under the core *O*. The pointer is a thin tube of aluminum, flattened at the end. The whole is inclosed in a dust-tight case, with a glass over the scale. From the description it should be evident that abuse, such as setting the meter down with a jar, or applying excessive currents, will ruin it.

Moving Coil Galvanometer.—For very delicate measurements, where even a milliammeter is not sensitive enough, the pivots and springs are done away with and the coil is suspended by a long, fine wire or strip, which conducts the current to it and at the same time opposes the turning effort due to the current. Another fine wire at the bottom provides the other connection to the coil. If the suspension wire is fine enough and the coil has many turns, such an instrument, called a "moving coil galvanometer," can be used to measure currents less than a millionth of an ampere. No pointer is used; a tiny mirror, attached to the coil, changes the direction of light reflected from it as the coil turns.

Ammeters.—An instrument of the type of Fig. 88 can be built only for small currents, otherwise the coil and other parts would be so huge as to be unwieldy. For larger currents the scheme of Fig. 89 is used. The current in *A* is to be measured. *S* is a short resistor called a "shunt," consisting of one or several strips of a special alloy large enough to carry the current.

The current divides, most of it going through S , because its resistance is small. A little of it flows through the millivoltmeter M , of which the resistance is large compared with S . This current in M , though small, is a perfectly definite fraction of the total (Sec. 25); therefore, if we know how great it is, we can know at once how great the total is.

For example, if the resistance of S is 0.01 ohm and that of M is 0.99, then the current divides in the same ratio, the larger part flowing in the path of smaller resistance. Out of every unit of current 0.99 flows by way of S and only 0.01 passes through the millivoltmeter. The total is 100 times as great as the current in M . If the resistances are 0.001 and 0.999, then the total is 1,000 times as great. The small current in the meter is an accurate measure of the much larger current in A ; for any one shunt the scale is therefore made to read directly in amperes of total current.

The number of amperes giving full scale deflection is also stamped on the shunt. It should agree with the scale of the meter.

Instruments of moderate range, say up to 75 amperes in one type, may be had with the shunt built in, concealed within the case. The binding posts are then of massive brass, with good sized holes for attaching wires.

Aside from avoiding rough treatment, or connecting it to carry a greater current than it is built for, the chief precaution in using an ammeter is to connect it as shown in Fig. 89, page 139, and not as in Fig. 90, which connection would cause its instant destruction. That is, the circuit is interrupted at some point and the shunt (or the instrument as a whole if it is self-contained) is inserted. If not a self-contained instrument, the millivoltmeter should then be connected to the terminals of the shunt *after* the latter has been securely connected in the circuit.

Voltmeters.—The type of movement used in ammeters is also used in voltmeters, but the latter are connected to the circuit in a different way, which involves certain differences between the instruments.

In Fig. 90, A and B represent two wires connected to the terminals of a battery. It is desired to measure the difference of potential, in volts, between them. M is an instrument like that of Fig. 88 and R is a wire of such great length and small

diameter that its resistance is sufficient to keep the current sent through the instrument within proper limits. In one very well-known make this resistance is around 15,000 ohms for a meter reading up to 150 volts.

The current flowing through the instrument, by Ohm's law, is equal to the volts between *A* and *B* divided by the resistance of *R* plus *M*. Any change in the voltage will cause an exactly proportional change in the current in the instrument. Therefore it is possible to graduate the scale directly in volts. As a matter of fact, for ordinary voltages, *R* is usually wound on

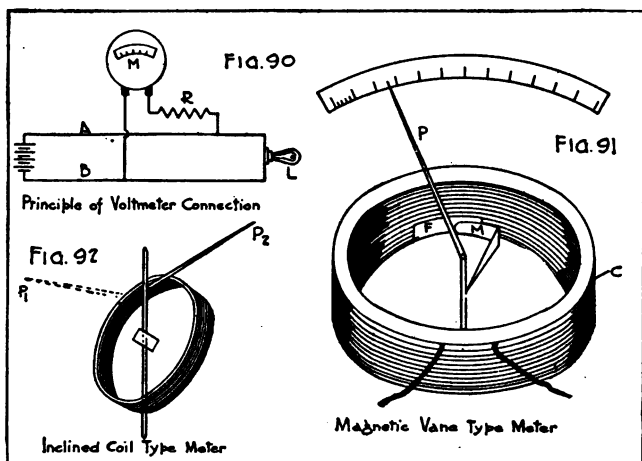

spools or thin mica cards which occupy little space and are fastened permanently inside the case of the instrument, out of the way of the user. He has merely to connect one binding post of the instrument to each of the two points in question. The pointer indicates on the scale the voltage between them. The main precautions to be taken in using a voltmeter are (1) never to connect it between points of higher voltage than the scale will indicate, even for an instant; (2) not to shake or otherwise roughly handle it; (3) always connect the positive terminal of the voltmeter to the positive side of the circuit.

The resistance of a voltmeter may be made sufficiently low, without introducing serious sources of inaccuracy, to permit of

its being used to measure small fractions of one volt, in fact one standard form is made to give full scale deflection on 0.02 volt. Such instruments are graduated in millivolts and are called "millivoltmeters." Even when it is used as in Fig. 89, p. 139, to measure current, there are reasons why the instrument should have some resistance besides that of the copper wire in the coil. This accounts for the statement, made in connection with that figure, that *M* is a millivoltmeter.

Ammeters and voltmeters can readily be distinguished, not only by the marking of the scale, but by the terminals. Those of an ammeter are large, and made to receive fairly thick wire; those of a voltmeter are smaller, having insulating caps; the screw threads are fine, and it is evident that they are made to receive only thin wires, as is to be expected because a voltmeter takes a very small current, usually less than 0.01 ampere.

Other Types of Instruments.—For low frequency a.c. measurements, instruments with a permanent magnet can not be used, and the thermal type has not had as wide application as those types which make use of the magnetic effect of the current on a piece of soft iron.

Fig. 91 illustrates the principle of one soft iron type. Current flowing around the coil *C* magnetizes the thin iron strip *F*, which is fixed in position by a stationary support. In the same way it magnetizes the other strip *M*, which is movable, being supported from the same shaft that carries the pointer *P*. The tops of both strips are at any instant of the same polarity, and the bottom edges of both are of the opposite polarity to this (but of the same polarity to each other). They therefore repel each other; the strip *M* moves to the right, and the pointer turns with it. The motion is opposed by spiral springs, as in Fig. 87.

If an instrument of this type is to be used as an ammeter, the coil is made of a few turns of large wire; if it is to be a voltmeter, many turns of fine wire are used and a resistance *R* is placed in series with the coil, inside of the case, as in Fig 90.

It will be seen that such an instrument will respond to alternating currents, for when the current reverses, the magnetization of both of the iron vanes reverses at the same time, so they continue to repel each other.

Another way of utilizing the magnetic effect is shown in Fig. 92. The coil is inclined, and a little iron vane, also in-

clined, is carried on the pointer spindle. When the pointer is held in the position P_1 by the controlling spring, the vane does not point in the direction of the axis of the coil. The current sets up a field and magnetizes the vane which then tends to set itself along the axis of the coil, turning the spindle in doing so, and moving the pointer against the force of the spring to some position P_2 . The difference between ammeters and voltmeters of this type is the same as in the preceding form.

K. Wire Telegraphy and Telephony.

60a. **Wire Telegraphy.**—An ordinary wire telegraph system consists simply of an electric circuit connecting two stations and simple equipment inserted directly in the line at each station. The same kind of equipment is generally used at each station, and communication can be had in either direction. On short lines the equipment of each station consists of a "key" and a "sounder" connected in series in the line. The key is a simple device for rapidly opening and closing the circuit and is so constructed that it can be conveniently and rapidly operated by hand. There is only a small clearance between the contacts of the key. When the key is not being operated and is up in its normal position the circuit is open. At all times when no signals are being transmitted at a given station the terminals of the key are short-circuited by a switch. The sounder is an electromagnet with an armature so mounted, close to the poles of the electromagnet on a pivoted arm, that the armature moves through a small distance when the current passes through the magnet windings. The end of the arm moves between two fixed stops, which may be screws. The arm moves in accordance with the current impulses on the line, corresponding to the opening and closing of the key at the distant station, and the contact of the end of the arm with the stops causes a click both when contact is made with the lower and with the upper stop. Signals are transmitted by means of depressing the key to make "dots" and "dashes." A dot is made by depressing the key for an instant; a dash is made by holding the key down a little longer. A dash is equal in length to three dots. Messages are transmitted by a "code" or arrangement of groups of dots and dashes representing the letters

of the alphabet. The code used on land lines in the United States is the "Morse" code. On the Continent of Europe land lines use the "Continental" code or "International Morse code." This code is used throughout the world in radio telegraphy. The International Morse code is given in Appendix 7.

In ordinary practice there is only one wire between two stations, and one terminal of the station apparatus at each end is connected to the earth, through which the return current flows. Ordinarily a number of intermediate stations are cut in on a telegraph line at points between the two terminal stations. Telegraph lines are usually operated as closed circuits—that is, current is flowing through the line at all times except when the line is actually in use for transmitting signals. The power for operation may be supplied by a closed-circuit battery, such as a battery of "gravity" cells, or by a direct-current generator. On all except short lines the line current is not strong enough to operate a sounder directly so that signals can be read, and a relay is connected in the line. The operation of the relay by the line current opens and closes a local circuit which operates the sounder.

The telegraph system here described represents the simplest case. In actual practice many modifications may be made. Signals may be transmitted and recorded at high speed by automatic apparatus. There are very few operators who can copy as many as 50 words per minute, but with automatic apparatus several hundred words per minute may be transmitted. With suitable apparatus it is possible at one time to transmit several messages over the same wire without one message interfering at all with the others; this is called "multiplex" telegraphy. Many other modifications may also be found. For further information see "Telegraphy," by T. E. Herbert, or "Modern Land and Submarine Telegraphy," by G. S. Macomber.

60b. Wire Telephony.—In ordinary telephony the voice itself is electrically transmitted over wires and reproduced at a distant point. The essential parts of a simple telephone system are (a) a device called the "transmitter," by means of which sound vibrations cause corresponding variations of an electric current, (b) a device for changing the electric current variations back into the corresponding sounds, and (c) an electric circuit for connecting the two devices.

In the telephone exchanges in use in large cities the connecting circuit and switching apparatus are very intricate. In some cities automatic switching equipment is in use for connecting subscribers at the central office. This equipment operates automatically directly under the control of the calling subscriber, without an operator at the central office, and may be very elaborate.

Microphone Transmitters.—The device by means of which sound vibrations cause corresponding variations of an electric current is usually the carbon microphone transmitter. This type of transmitter is a speech-controlled variable resistance, and its operation is based on the fact that the resistance of carbon varies with pressure changes. A low voltage, as from a battery of a few cells, is connected to opposite sides of a small cup containing carbon granules. The pressure on the carbon granules is controlled by the position of a metal diaphragm on which the sound is impressed.

Fig. 93a shows a telephone transmitter of a type which is in general use throughout the United States, called the "solid-back" transmitter. This name is used because the cup containing the carbon granules is supported on a solid back which consists of a metal bar attached at its ends to the case of the transmitter. In the figure *D* is the diaphragm, usually an aluminum disk about $2\frac{1}{2}$ inches in diameter. *T* is the solid back, on which is mounted the metal cup *B*, containing the carbon granules *C*. At the back of the cup is a small hardened carbon plate *E*, which serves as one electrode of the carbon microphone. At the front is another very hard carbon plate *F*, which serves as a lid for the small metal cup. The diameter of this plate is a little less than the diameter of the inside of the cup, but the cup is completely closed by a flexible mica disk, which is attached to the rim of the cup and to the carbon disk. This carbon lid or cover forms the second electrode of the transmitter. The button *L* attached to the carbon plate *F* is maintained in contact with the diaphragm by a metal spring *S*, which serves also to damp the vibrations of the diaphragm. The space between the carbon cover *F* and the back electrode *E* is nearly filled with carbon granules, and the electrodes *E* and *F* are so insulated that the electric current in the transmitter circuit, in passing from one electrode

to the other, passes through the entire mass of carbon granules. The two wires leading to the transmitter are connected to the binding posts *G* and *H*. The metal face *K* of the transmitter is made heavy to prevent excessive vibration, and the exposed metal parts are usually insulated from the current-carrying parts. In practice it is not usually found desirable to have the transmitter extremely sensitive, because outside noises are

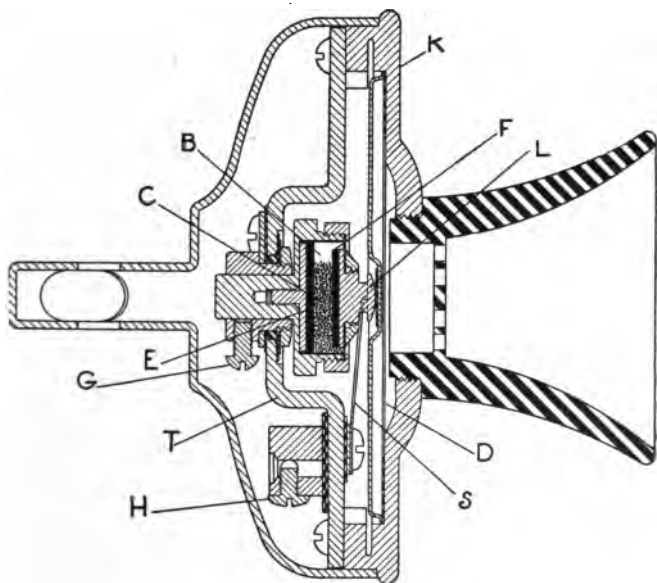

FIG. 93a.—Microphone transmitter.

then transmitted, and it is therefore difficult to understand the speech. The current through the usual type of microphone transmitter is about 0.2 ampere, and the power consumed in the transmitter is about 2 watts.

The microphone transmitters used in radiotelephony at the present time do not differ essentially from those used in wire telephony, and, in fact, the identical transmitter usually furnished by operating telephone companies can be used for radiotelephony.

Telephone Receiver.—The device by means of which the variations in the electric current reproduce the corresponding sounds is the telephone receiver, which is made in a variety of forms. The type of receiver shown in Fig. 93b, called the "watchcase" receiver, is often used in wire telephony, and is almost universally used in both radiotelegraphy and radiotelephony. Two watchcase receivers are commonly used together, connected by a metallic "headband," constituting a "head set." In Fig. 93b, *C* is a cup which is the case of the receiver. This cup may be metal or hard rubber or a composition. In the bottom of this cup a permanent magnet of horseshoe shape is placed; the ends of this permanent magnet are shown at *HH*. To the ends of the permanent magnet are attached the bent, soft-iron pole pieces *NP*, *SQ*. The earpiece *E* is usually hard rubber or a composition and is threaded to the cup *C*. Around each pole piece a coil of fine insulated wire is wound, forming the windings *MM*. These two windings are usually connected in series, so that the received current passes through both windings.

In some instruments for use with feeble currents the wire is very fine and the two coils contain some thousands of turns, sometimes as many as 10,000 turns. In the ordinary standard receiver the number of turns is, roughly, about 1,000. The resistance measured with direct current of a receiver for wire telephony may vary considerably, but for the standard receiver is usually about 100 ohms. A receiver designed for the very feeble currents sometimes used in radio communication may have a d. c. resistance of 8,000 ohms, and seldom has a resistance of less than 1,000 ohms. The coils of a receiver, particularly those designed for radio work, have considerable inductance, and at high frequencies the impedance in ohms of the coils of the receiver may be many times the resistance of the coils measured with direct current. The larger the number of turns used the greater is the magnetic effect in the receiver for a current of given strength. The use of telephone receivers in radio communication is discussed in Section 180.

Above the pole pieces and very close to them is a thin circular soft-iron disk *D*, called the "diaphragm." The diaphragm of a receiver can be seen through the hole in the center of the earpiece. The distance between the pole pieces and the dia-

phragm is important in determining the sensitivity of the receiver; in standard instruments this distance is about 0.003 inch. The permanent magnet pulls the diaphragm toward the pole pieces a certain distance, which depends upon the flexibility of the diaphragm. The variations in the current in the receiver windings, corresponding to the sound vibrations of the voice spoken into the transmitter, produce corresponding variations in the magnetic field of the pole pieces, and the diaphragm moves in accordance with these variations and reproduces the voice spoken into the transmitter.

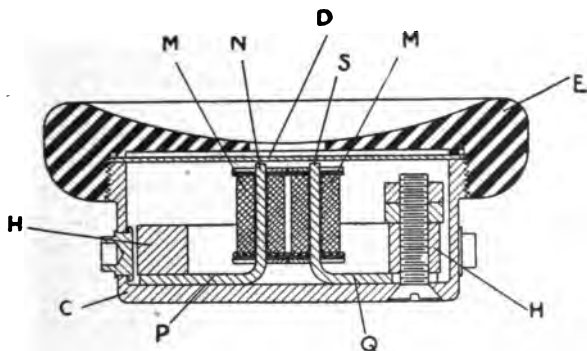

FIG. 93b.—Watch case telephone receiver.

It is possible to use a telephone receiver as a transmitter. With a circuit containing only two identical sensitive telephone receivers and no battery, the same instrument can be used alternately as receiver and transmitter by the person at each end of the line, and speech thus transmitted. This was, in fact, done in the early days of telephony, but the currents so generated by using the receiver as a transmitter are so feeble that other devices are now used for practical purposes.

Operation.—Words spoken into the transmitter vary the pressure on the carbon granules, and hence the resistance between the transmitter terminals and corresponding variations in the output current of the transmitter are thus produced. The nature of the electric current transmitted by the wires leading to the receiving station depends upon the auxiliary apparatus used with the transmitter. The electric current passing be-

tween the stations is often a feeble alternating current having a frequency from perhaps 100 cycles per second to 3,000 cycles per second, considerably higher than the frequencies used for commercial lighting purposes. (See Sec. 50.) These frequencies, in fact, correspond to the frequencies of the sound waves impressed upon the transmitter diaphragm. Thus the note "middle C," which corresponds to a sound wave having 256 vibrations per second, causes an alternating current having a frequency of 256 cycles per second. It should be noted, however, that the wave forms produced by speech or by musical sounds are by no means as simple as the sine wave shown in Fig. 71. In the case of some kinds of telephone systems the wires may transmit a pulsating direct current of several tenths of an ampere, whose pulsations correspond to the impressed sound waves. The electrical transmission of speech is more fully described in connection with radiotelephony. (See Secs. 206-212.)

Speech transmitted by telephone instruments is not entirely natural, because the vibrating parts, both electrical and mechanical, of the telephone equipment used produce distortions during the transmission of the sound. In the early days of telephony, when the causes of distortion were not well understood, serious effects of this kind occurred when talking over very short distances. At the present time it is possible to talk from New York to San Francisco by wire. This result has been attained only after years of experience and investigation and the development of instruments involving principles only recently discovered. Successful transmission over such long distances requires many refinements in the design of every device used.

It is possible at the same time to transmit both telegraph and telephone messages over the same line; such a line is often called a "composite" line.

With the currents used in ordinary telephony, it is possible at the same time to transmit three telephone messages over two pairs of wires by adding at each end a "phantom" circuit, which is an additional circuit balanced across the two main circuits through suitable impedances. For information regarding phantom circuits, see the books mentioned in the next paragraph. The operation of a telephone system so that

one pair of wires carries more than one message is called "multiplex telephony." Besides the use of the phantom circuit, multiplex telephony can be attained by the use of alternating currents of the high frequencies used in radio communication. (See Sec. 212.)

For further information regarding wire telephony, the reader may consult G. D. Shepardson, "Telephone Apparatus"; K. B. Miller, "American Telephone Practice"; or H. R. Vandeventer, "Telephonology." In a book by David P. Moreton, "Drake's Telephone Handbook," may be found an elementary exposition of the principles of telephone apparatus, and detailed information regarding practical methods of construction and operation of various kinds of telephone systems, which may be of particular interest to the beginner.

Circular 112 of the Bureau of Standards, "Telephone Service" (1921), gives detailed information regarding the operation of various kinds of telephone systems, and will be found valuable for reference.

CHAPTER 2.

DYNAMO-ELECTRIC MACHINERY.

61. Generators and Motors.—In the preceding chapter some laws of electric and magnetic circuits are discussed, and attention is directed to the relations between electric currents and magnetic fields. In the present chapter certain practical applications will be described, in which use is made of all those laws, but which are based particularly on three experimental facts, namely, that—

1. When a conductor is moved across a magnetic field, an emf. is induced in the conductor.
2. When a current flows in a conductor in a magnetic field, a cross-push is exerted on the conductor.
3. When a current is sent around an iron core, the core is magnetized.

The forces involved are not necessarily small, as is sometimes imagined, but may run into hundreds or even thousands of kilograms. Such forces can be used for power applications on a large scale, by means of machinery, called “dynamo-electric” or, for short, “electrical” machinery.

Electric machines are used for conversion of power from mechanical to electrical form, or vice versa. If driven by some sort of prime mover like a steam engine, gas engine, or water wheel, they convert mechanical power into electrical power and are called “generators.” If supplied with current and used to drive machinery, vehicles, or other devices, thus converting electrical power into mechanical power, they are called “motors.”

While there are various types of motors and various types of generators, the difference is more in the use than in the construction or appearance; in fact, the difference between most motors and the corresponding kinds of generators is so slight that the same machine can be used for both purposes with no changes, or only minor ones. Electric machines may be built for either direct or alternating current.

A. The Alternator.

62. **Production of Emf. by Revolving Field.**—It was pointed out in Chapter 1, Section 45, that the motion of a conductor across a magnetic field causes an electromotive force in the conductor. This is true whether it is the conductor or the magnetic field that actually moves; the essential thing is that there shall be relative motion of one with respect to the other.

One way in which such relative motion may be secured is illustrated by Fig. 94. Suppose the magnet NS is made to rotate continuously in a vertical plane about the axis mn . The loop of wire ab is stationary. Its ends are connected to some external part of the circuit X . As the field from the N pole sweeps across a , an electromotive force is induced in it to the right and at the same time an electromotive force is induced to the left in b by the passing of the S pole. Thus the emf. produced tends to send a current in a clockwise direction around the loop ab , as indicated by the arrows.

When the magnet has made half a revolution the poles have exchanged places with respect to a and b and the electromotive forces are counter-clockwise around ab . As the magnet continues to be rotated, there are thus two pulses of electromotive force (and of current if the circuit is closed) in opposite directions for each revolution of the magnet. The device described constitutes a simple "alternating-current generator" or "alternator."

63. **Direction of Emf.**—The direction of the electromotive force induced in a straight conductor moving across a magnetic field can be determined by the "right-hand rule." This rule as generally stated assumes that the magnetic field is stationary and that the conductor moves across the magnetic field. Using the *right* hand, the thumb, the first finger, and the second finger are so placed that each is at right angles with the other two, the first finger being extended directly out. Then if the thumb is pointing in the direction of motion, and the first finger is pointing in the direction of the magnetic lines of force (from north pole to south pole), then the second finger will point in the direction of the induced emf; that is, in the direction in which the induced current will flow.

If the magnetic field is moving, and the conductor stationary, the rule is readily applied by recalling that the relative motion is the essential thing. Thus in Fig. 94 the effect of having the north pole move toward the reader, passing the conductor *a*,

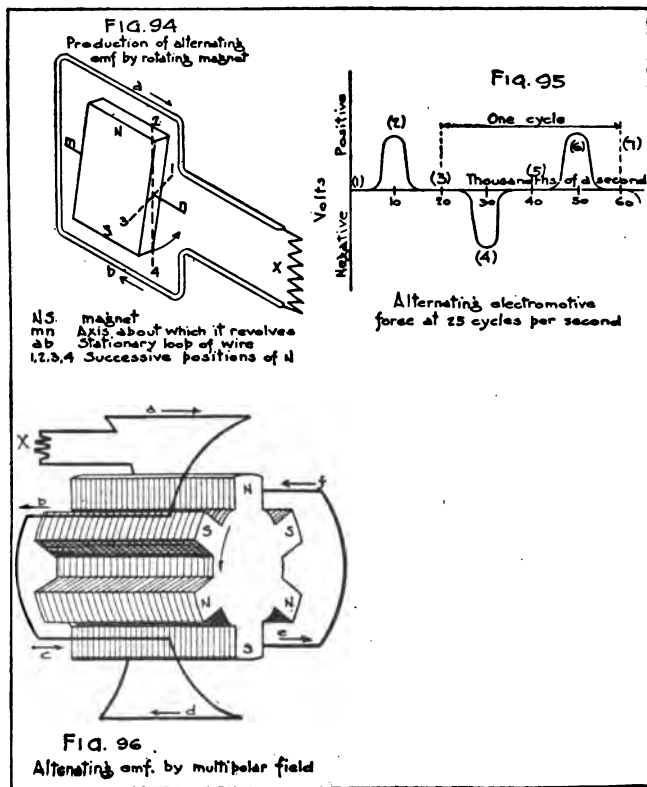

is the same as if the conductor were to move away from the reader, passing pole *N*.

A similar *left-hand* rule can be used for determining the direction in which a straight conductor carrying a current will move if placed across a magnetic field. Using the *left* hand, the

thumb, the first finger, and the second finger are so placed that each is at right angles to the other two, the first finger being extended directly out. Then if the first finger is pointing in the direction of the magnetic lines of force and the second finger is pointing in the direction in which the current is flowing, the thumb will point in the direction in which the conductor will move.

The reader may compare these rules with the rule for the direction of the magnetic field about a straight conductor carrying a current, as stated in Section 4, page 30, and with the rule for the polarity of a solenoid stated in Sec. 42, page 106.

64. Emf. Curve.—If the electromotive force is called positive when to the right in a , and negative when to the left, the changes in it may be shown by a curve like Fig. 95. Successive moments of time are taken along the horizontal axis, and the corresponding electromotive forces are shown by the height of the vertical ordinates. When the north pole is in position 1, Fig. 94, no emf. is induced. This is shown by the point marked 1, Fig. 95. A short time afterward, in position 2, Fig. 94, a certain maximum emf. is induced, shown by point 2 on the curve. When the pole has moved to position 3 the electromotive force has decreased to zero, and in position 4 it has reached a negative maximum. It then decreases again to zero and the whole series is repeated.

A curve like the one in Fig. 95 is often called an electromotive force curve or wave.

The emf. curves generated by commercial alternators have a variety of shapes, but ordinarily they are not very different from sine curves, and for reasons given in Chapter 1 are usually treated as such.

65. Cycle, Period, Frequency.—A regularly recurring series of values of electromotive force, from any point in the series to the corresponding point in the next series, is called a "cycle." The portion of the curve in Fig. 95 from 3 to 7 represents a cycle; similarly, the portion from 2 to 6. The time required for one cycle is the "period." The number of cycles per second is called the "frequency."

In American commercial practice, 60 and 25 cycles per second are the most common frequencies for alternating current circuits. The corresponding periods are $\frac{1}{60}$ and $\frac{1}{25}$ of a second.

Other frequencies, for example, 50 cycles, are used in Europe. For certain purposes in radio telegraphy, 500-cycle generators are used. Quite recently, special machines have been developed for generating frequencies as high as 100,000 cycles per second, to be applied directly to the radio circuits. This frequency corresponds to a radio wave length of 3,000 meters.¹

66. Multipolar Magnets.—To produce a frequency of 60 cycles per second by the use of a single magnet with two poles requires a speed of rotation of 60 revolutions per second. Such a speed is not practicable for large machines. To get 500 cycles would require 500 r. p. s., or 30,000 r. p. m. (revolutions per minute). By arranging a number of similar north and south poles alternately, as in Fig. 96, and providing corresponding conductors, a lower speed of rotation may be used. As in Fig. 94, the magnet is supposed to be made to rotate, while the conductors *a, b, c, d, e, f* remain stationary.

When the upper north pole is coming toward the reader, electromotive forces will be induced in the several conductors in the direction of the arrows. The conductors are all connected in series, except between *f* and *a*, where connection is made to an external part of the circuit, *X*. All are in the same relative position to the several magnetic poles; their electromotive forces are equal, and in the case shown, the total is six times as great as the electromotive force in any one conductor.

For every revolution of the magnet, each conductor is passed three times by an *N* and three times by an *S* pole. Each pair of poles gives rise to a cycle, so for each revolution there are three cycles of emf. in the conductors. Thus, for a given speed, the frequency is three times as high as it would be if there were but one pair of poles.

67. Field and Armature.—The magnets (*NS*, in Fig. 96, p. 116) which produce the magnetic field of an alternator are called the "field magnets." If there is but one north and one south pole, the machine is said to be "bipolar"; if there are several pairs of poles the machine is "multipolar."

The conductors in which the electromotive forces are induced constitute the "armature winding." The winding is supported, usually by being embedded in slots, well insulated, on an iron or

¹ Wave length is explained in Sec. 125. High-frequency alternators are described in Secs. 95 and 173.

steel core called the "armature core." Winding and core together constitute the "armature," though this term is also used loosely, when the armature winding alone is meant.

68. **Coil-Wound Armature.**—The electromotive force developed in one conductor of an ordinary generator is only a volt



FIG. 97.—Windings partially assembled in a 25-cycle synchronous motor.

or two, not enough for practical use. Armature windings, therefore, consist of a large number of conductors, usually combined into coils (see Fig. 97) of several turns each, which are pushed into slots in the face of the armature core and then connected by soldering. The joints have to be carefully covered with tape or other insulating material.

The coils are made of copper wire covered with insulation (usually cotton) wound to the proper shape on a form, wrapped with tape, and finally covered or impregnated with an insulating compound. The core slots are often lined with tough, heavy paper or fiber. After being placed on the core, the coils are held by wedges of fiber or wood driven into the tops of the slots.

The core is built up of thin, flat sheets of soft iron or steel, ring-shaped, with teeth on the inner edge.² See Fig. 98. Enough sheets are stacked up to make a cylinder of the length



FIG. 98.—Laminations partly assembled, making up the armature core of a skeleton frame alternator.

desired. Occasionally a separator is included to provide air ducts through the core for ventilation. The three dark rings around the core in Fig. 97 show where the ducts are. The teeth are carefully lined up, and the spaces between them become the troughs or slots for the windings.

How the emf. increases and decreases in such a winding can be studied from Fig. 99. Here the coils are drawn as if the armature were unrolled and opened out flat. The magnet poles are supposed at the given instant to be over the rectangles

² See section 78, p. 173.

marked *N* and *S*. Each of the numbered lines in the figure may represent either a single conductor or one side of a coil. Only a portion of the armature winding is represented.

Imagine the poles in Fig. 99 to be moving toward the right, the conductors 1, 2, 3, etc., remaining stationary. Starting at the instant when a north pole is just approaching conductor 1, and a south pole is just approaching conductor 5, electromotive forces will be induced in the directions shown by the arrows. As conductors 2 and 6, 3 and 7, etc., are reached, additional electromotive forces are induced. The maximum comes when the *N* pole covers 1, 2, 3, and 4, and the *S* pole covers 5, 6, 7, and 8. After that the

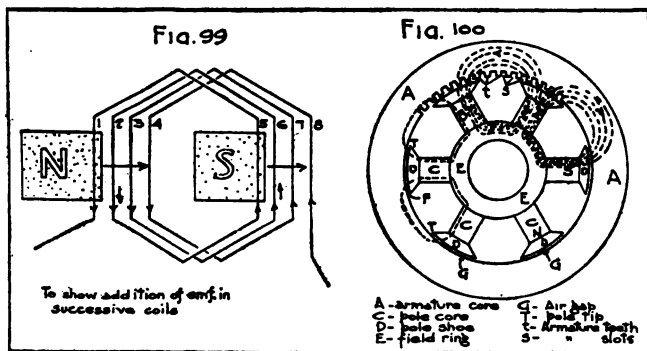

resultant electromotive force begins to decrease, falling to zero and then beginning to increase in the opposite direction. In this manner an alternating emf. is gotten in which the changes occur gradually as conductors get into or out of the magnetic field one by one, or at least coil by coil. In addition the edges of the poles are usually tapered off ("chamfered") to make the changes still smoother.

60. Concentrated and Distributed Windings.—Sometimes all the turns for one pair of poles are combined into one coil, which is put into a single pair of large slots, one for each pole. Such a winding is a "concentrated" winding. (See Fig. 103.) When the portion of the core under each pole face contains a number of slots in which the coils are placed, the winding is "distributed." (See Figs. 97, 99, 100.)

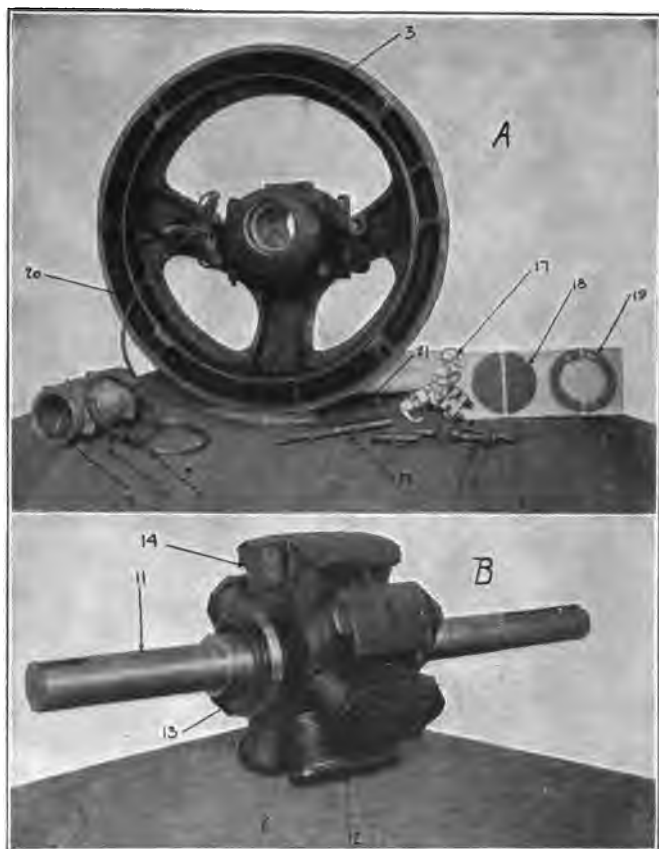
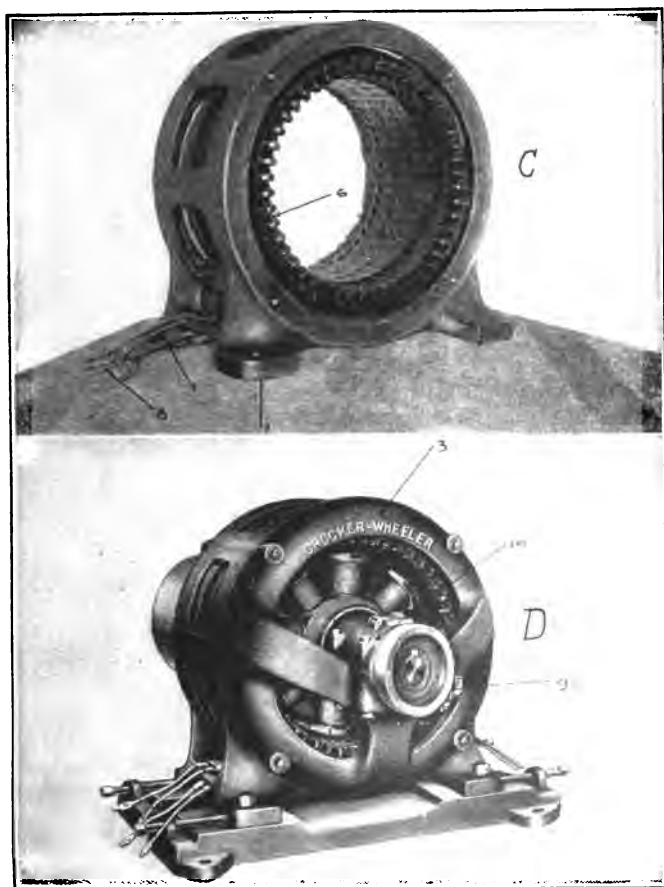

FIG. 101-A-B (C and D on opposite page).—Alternating-current generator, 150 KVA., 900-R. P. M., 60-cycle. Single phase. Dismantled parts listed below.

- | | | |
|--------------------|--|---|
| 1. Stator frame. | 9. Oil gauge. | 16. Journal box set screw. |
| 2. Complete rotor. | 10. Oil hole cover. | 17. Twin unit brush holder, with brushes. |
| 3. Shields. | 11. Shaft. | 18. Dust cap. |
| 4. Journal boxes. | 12. Pole shoe. | 19. Dust washer. |
| 5. Oil rings. | 13. Collector ring. | 20. Rotor leads. |
| 6. Stator winding. | 14. Field coil. | 21. Rotor lead cable tips. |
| 7. Stator leads. | 15. Cap screws for holding shields to frame. | 22. Brush stud. |



70. Magnetic Circuit.—It is important to get an understanding of the magnetic path in an electric machine. Various shapes are possible, but an understanding of one makes all others easy. Fig. 100 is a diagram indicating the parts of a typical magnetic circuit, with their names. It is not intended to show details of mechanical construction. The fine lines in the upper part of the figure show the path of the magnetic flux for one

pair of poles. The paths for the other poles are similar. The armature conductors are placed in the slots *ss*.

71. Field Excitation.—Thus far nothing has been said as to how the magnetic field is produced. While permanent magnets might be used, they are not satisfactory for practical purposes, except in the very little machines called “magnetos.”^a Electromagnets are therefore used. The poles are fitted with coils or spools of wire, usually of a large number of turns, through which direct current is sent from some external source.

The coils are connected to a pair of metallic rings, called “slip-rings” or collector rings, which are in contact with conducting strips, called “brushes,” connected to the source of current. As the entire field structure rotates, current is brought to the coils through the sliding contacts of the stationary brushes with the revolving slip-rings.

The source of direct current is usually a separate small direct-current generator, which when used for this purpose is called an “exciter.” If used for one alternator alone its output will range from 1 to 3 per cent of the rating of the alternator. When the alternator is very small, like those used in the Signal Corps portable radio sets, the exciter is larger by comparison.

72. Stator and Rotor.—When it is desired to refer to the stationary and rotating members of a dynamo-electric machine without regard to their functions the former is called the “stator” and the latter the “rotor.”

73. Arrangement of Parts.—A good idea of the parts of a revolving-field alternator is obtainable from the pictures in Fig. 101, which show a complete machine, as well as views of the most important parts. The general view shows how the parts fit together.

Through the holes in the ventilated iron frame of the stator the outside of the core is visible. On the inside of the core the laminations can be dimly seen. The two dark rings which seem to divide the core into thirds are ventilating ducts. Where the windings lie in the slots they are concealed by the wedges, but the ends of the coils are in plain view. Note that

^a A discussion of the principles of the magneto may be found in Bureau of Standards Scientific Paper No. 424; 1922.

the coil ends are given a twist to make a neat construction. The four terminals at the left of the stator indicate a two-phase machine (Sec. 75).

The right-hand end shield shows one brush holder in place, to the left of the bearing; the little hole to the right of the bearing is for the stud on which the other brush holder (lying in front) is to be mounted.

The brushes of one set slide on one collector ring, and those of the other set on the other ring. Two brushes are used in each set, in this particular machine, in order to have a large and reliable contact. The ends of the cables leading to the brushes are in view on the right of the complete generator.

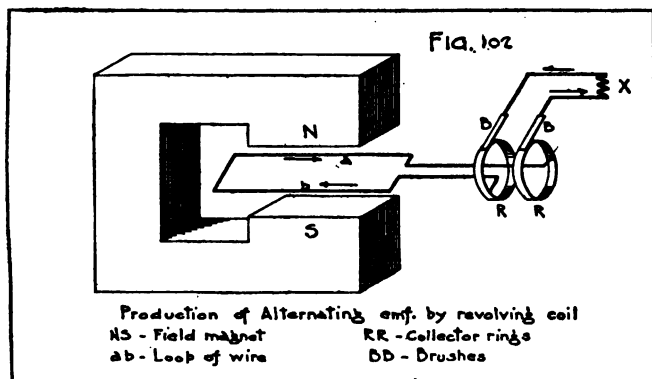

On the rotor the pole shoes are noticeable, held on by six screws. One of the connections between field coils is seen between the upper pole shoe and the one just in front of it, near the center of the shoe. The massive ring to which the pole cores are attached is also visible. There are two collector rings close together, though it is a little difficult to distinguish them in the picture.

74. **Other Forms of Alternator.**—Thus far we have considered alternators of which the field magnets revolve, while the armature is stationary. That is the construction generally used on large machines, one reason being that it makes the armature easier to insulate. But it is also possible to have the field magnets stationary while the armature is made to revolve. Small

machines are often built this way. The principle is shown in Fig. 102.

The magnetic field occupies the space between the poles *N* and *S* of the stationary field magnet. The turn of wire *ab* is made to revolve about a horizontal axis in this magnetic field.

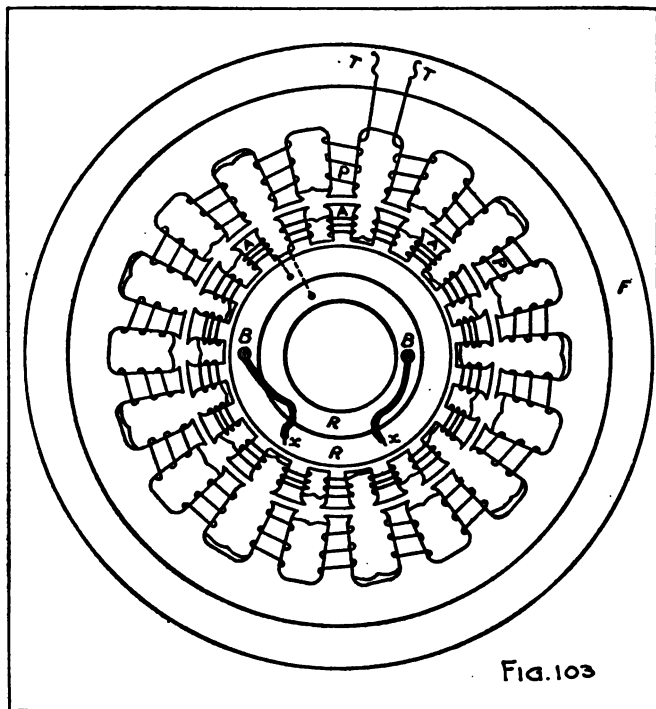

FIG 103.—Circuit diagram of revolving-armature alternator. A, armature; F, frame; P, poles; R, collector rings; B, brushes; TT, terminals of field circuit; XX, leads to external circuit.

When *a* is passing under the *N* pole, coming toward the reader, the electromotive force in it is to the right, and that in *b* which is cutting through the same field (the direction of the magnetic flux is from the *N* pole into the *S* pole), but moving away from the reader is to the left. Current will therefore

flow in the turn of wire, and by way of the collector rings and brushes in the external circuit, as shown by the arrows.

When the loop has made half a revolution, *a* is passing in front of the *S* pole and the electromotive force in *a* is toward the left. In *b* it is toward the right. In the external portion, *X*, of the circuit the flow of current will then be opposite in direction to the arrows. The continued rotation of the loop thus causes an alternating current to flow in the circuit.

The simple bipolar magnet of Fig. 102 may be replaced by a multipolar electromagnet consisting of a massive cylindrical frame called the "yoke," from which poles project radially inward. Direct current is sent through coils or spools on the magnet poles. The same kinds of windings are used for the revolving armature as are used for the stationary kind; the only difference is that they are put on the outside instead of on the inner face of the core.

A machine in which the field magnets are stationary, while the conductors, in which the electromotive force is induced are rotated, is said to be of the "revolving-armature" type. A diagram of such a machine, used in one form of radio pack set, is given in Fig. 103.* The armature winding in this case is of the concentrated type. A picture of a generator very much like it appears in Fig. 122.

It has previously been shown that, when the field is made to revolve, slip-rings have to be used in the field circuit. Similarly, when the armature is the part that revolves, there must be slip-rings in the armature circuit to provide connection with the external portion. Such rings are shown at *RR* in Fig. 102.

Inductor Alternator.—Another type of alternator is of especial interest in connection with radio telegraphy. It is called the "inductor alternator," and is used particularly for the generation of continuous high-frequency currents, say, around 100,000 cycles per second, but is also used for lower frequencies.

*The little machine to which this diagram applies has 18 field poles and 18 armature teeth, runs 3,333 r. p. m., and generates current of 500 cycles frequency. It is designed for an output of 250 volt-amperes, to be used in a field radio pack set. The windings are shown only in diagram; actually the field coils average 250 turns each; the armature coils 19 turns each. The sketch is practically to scale, except the collector rings, which are drawn smaller so as not to conceal the armature. The whole diameter across the frame is about 15 cm. (6 in.).

The principle on which such machines operate is illustrated in elementary form in Fig. 104. The field magnet and the armature are both stationary. A considerable gap separates the armature core from the faces of the field poles. In this gap are masses of iron, *I*, free to revolve in a plane perpendicular to the plane of the paper about the axis *mn*. These masses of iron are called "inductors." Imagine them made to revolve by an external force. When the inductors are in the position shown, between *N* and *C*₁, and *S* and *C*₂, there is a certain magnetic flux, due to the d. c. excitation. When the inductors are not in that position, there are long air gaps in the magnetic circuit,

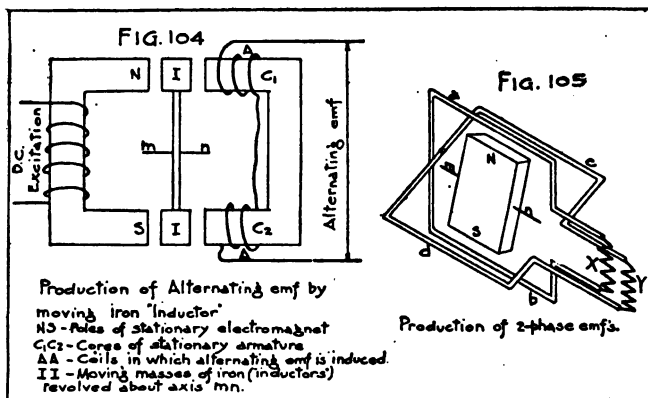

which have a very much smaller permeability than the iron conductors. The flux is consequently less. The increase and decrease of magnetic flux in the coils *A A* sets up an alternating emf., because any change in the flux inclosed by a circuit sets up an emf. in the circuit (Sec. 45) in the one direction while the flux is increasing, and in the opposite direction while it is decreasing.

In this type of alternator, the passing of each mass or inductor causes a complete cycle of emf., whereas with alternators of either the revolving field or the revolving armature type it requires the passage of two poles to cause a cycle.

75. Polyphase Alternators.—Suppose that in Fig. 94, p. 154, another loop similar to *ab*, but entirely independent of it, were

placed at right angles to ab , as shown at cd in Fig. 105. The rotation of NS would induce in the second loop an alternating emf. identical with that in the first, having the same frequency and the same series of values. The sole difference would be that they would reach corresponding points in the cycle at different instants of time, for at the moment when the poles were in line with the conductors of one loop, and it was having maximum emf. induced, the other loop would have none.

Suppose the emf. wave of the first winding is given by curve I, Fig. 106. Then curve II will represent the emf. of the other winding. The two curves are first shown separately and then combined into one diagram. They are alike in shape, showing that the two emfs. go through the same series of values, but II is always a quarter of a cycle behind I (see Sec. 53). Suppose the distance 0-4 represents $\frac{1}{4}$ second. Then whatever happens in I, at any instant, happens in II just $\frac{1}{16}$ second later. This is expressed by saying that there is a "phase difference" of a quarter cycle between them, or that the two emfs. differ in phase by a quarter cycle.

Two emfs. which differ in phase by a quarter of a cycle are said to be in quadrature. A generator giving such a pair of emfs. in quadrature is called a "two-phase" alternator. The two windings considered separately are called "phase windings," or, somewhat loosely, the "phases." Either one may be thought of as phase I and the other as phase II.

It will now be plain why the pictures of Fig. 101, show four terminals at the left. Two belong to one phase and two to the other.

There may be more than two phases; in fact, modern power-generators usually have three phase windings.

Definitions.—A machine for a simple alternating current is called a "single-phase" machine. Generators used exclusively for radio communication are generally single-phase.

A machine for alternating current of two or more phases is called a "polyphase" machine; polyphase generators are either two-phase or three-phase, almost without exception. They are used for power purposes.

Arrangement of Windings.—An idea of the way the windings of a polyphase generator are arranged may be obtained by re-

ferring back to Fig. 99. Suppose another winding to be added identical with the one shown, but occupying the spaces left vacant by the first winding.⁴ As the magnet poles move along the windings come into play alternately.

Notice that in a single-phase generator half the surface of the armature core has to be left vacant. In a polyphase gen-

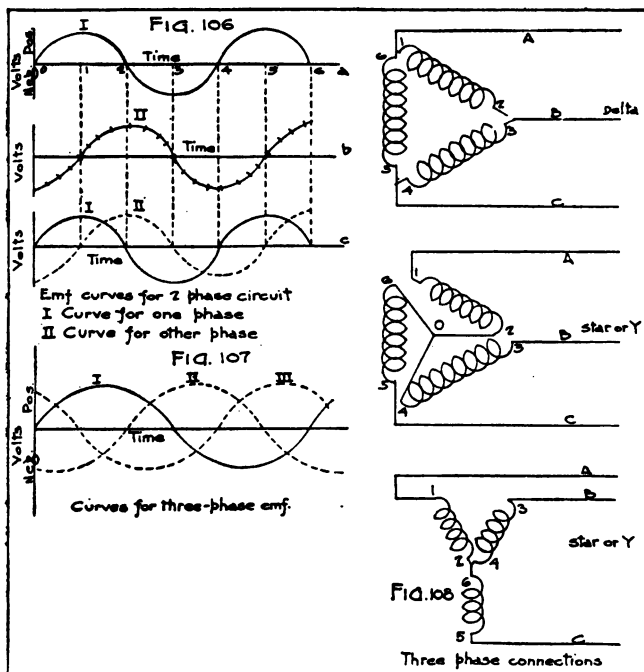

erator, on the contrary, the windings may cover the entire surface, and usually do.

Next, suppose the two-phase windings were each made narrower, leaving space for a third winding just as large as each

⁴ The reader who has difficulty in imagining the second winding may trace on transparent paper the winding shown and may then slide the paper to one side by the proper amount.

of the first two. We should then have three phase windings, and a given field pole would pass them one after the other. Thus would be produced three emfs. differing in phase by equal amounts.

By properly selecting the terminals, the three emfs. would follow one another as represented in Fig. 107, and it will be seen that now the difference between them is one-third of a cycle. In the time of one cycle each of the three comes to a positive peak one after the other. The emf. curves are shown in Fig. 107. The emfs. are often spoken of as differing by 120° .

It might be expected that a three-phase machine would have six terminals. As a matter of fact, the phases are usually so connected in the machine that three terminals are sufficient, as illustrated in Fig. 108. The three coils stand for the three armature windings. When joined as in the upper sketch, they are said to be connected in "delta"; when one end of each coil is brought to a common junction as at *O* in the middle figure they are connected in "Y" or "star." The lower figure is the same as the middle one, in that terminals 2, 4, 6 are all joined together and 1, 3, 5 are connected to the line wires *A*, *B*, *C*. By changing the position on the paper the connections are made to look simpler.

The scheme of connections is ordinarily of no interest to the operator, except in case of trouble, and cannot be determined without a close examination. The wires by which the connections are made are carefully wrapped and tucked away at the end of the armature, concealed by an overhanging part of the frame or by the end shield, which has to be taken off before the connections can be traced.⁵

⁵ Discussion of this subject can be found in any textbook on alternating-current machinery. See, for example, Timble and Higbie, "Alternating-Current Electricity, First Course," pp. 114-128; Franklin & Esty, "Elements of Electrical Engineering" (2 ed.), vol. 2, pp. 98-116.

B. Alternator Theory, Losses, and Efficiency.

76. Equations for Frequency and Emf.—The frequency of the emf. generated by an alternator of the revolving-field or revolving-armature type is given by the equation:

$$f = \frac{pn}{2} \text{ or } f = \frac{pn'}{120} \quad (65)$$

where f = frequency in cycles per second.

p = number of poles.

n = revolutions per second.

n' = revolutions per minute.

The passing of each pair of poles, $\frac{p}{2}$ in number, gives rise to one cycle. If there are n revolutions per second, the number of cycles per second is therefore $\frac{p}{2} \times n$. The second form of the equation is given, because the speed is commonly given in revolutions per minute.

For example: What frequency will a 12-pole alternator give when running at 5000 r.p.m.?

With 12 poles each revolution gives 6 cycles. In a minute there will be $6 \times 5000 = 30,000$ cycles. In a second there are $30,000 \div 60 = 500$ cycles. The machine gives 500 cycles per second. By the second formula we get the same answer

$$f = \frac{12 \times 5000}{120} = 500 \text{ cycles per second.}$$

For the inductor type the frequency is the same as the number of inductors which pass a given point per second. Thus 40 teeth at 25 r.p.s. give 1000 cycles per second. The inductors are usually in the form of teeth, somewhat like gear teeth, that project from the revolving part.

The emf. generated in an alternator depends on how much magnetic flux is cut by the conductors per second. Increasing either the magnetic flux from each pole, or the number of poles that pass a given conductor in a second, or the number of conductors connected in series (so that the effects in them are added together) increases the emf. of the machine in a corresponding way. This may all be stated in one equation.

$$E = \phi N f k \quad (66)$$

where E = effective volts (Sec. 51), as shown by a voltmeter.

ϕ = magnetic flux per pole, in maxwells or "lines of magnetic force."

N = number of turns of armature winding connected in series.

f = frequency in cycles per second.

k = a multiplier that depends on the arrangement of the winding and certain mathematical relations not necessary to consider here.*

77. Dependence of Driving Power on Current.—The power consumed in an electrical circuit at any instant is proportional to the emf. and also to the current. It is therefore proportional to their product. If the current is made to flow by means of a generator, and if the generator is driven by an engine of some sort, the power that has to be developed by the engine evidently depends upon the power used in the circuit. It is worth while to trace the reason why increased current in a generator calls for more power from the engine that drives it.

Let the simple loop in Fig. 102 be made to rotate at constant speed by any "prime mover" suitably governed. This prime mover may be anything that will make the loop go around—a man turning a crank, a gasoline engine, a steam engine, an electric motor, etc. At the instant when the loop is in the plane of the paper, and a is coming toward the reader, an emf. is being induced in it, in the direction of the arrow. If the circuit is closed, a current flows in the same direction. But it

* The student who has some previous knowledge of electricity will see that if $2f$ poles pass a conductor per second, the average flux cut per second is $2f \times \phi$. To generate 1 volt requires passing 10^8 lines of flux per second. Hence the average volts per conductor are $2f \times \phi \div 10^8$. Each turn consists of two conductors in series, so we multiply by 2. The voltmeter reads not average but effective volts. For sine waves the effective volts are 1.11 times the average, so we multiply by 1.11. Collecting all the numbers it is seen that k in the formula stands in part for $\frac{2 \times 2 \times 1.11}{10^8}$ or $\frac{4.44}{10^8}$. It also includes a factor, not greater than 1, depending on the kind of winding used, because if the winding is distributed, the emfs. in the various turns do not rise and fall together (there is a difference in phase), and this must also be taken into account.

is known (see Sec. 43) that when a conductor, carrying a current, is in a magnetic field, the conductor tends to move across the field. The force on the conductor is proportional to the strength of the field and to the current. The direction of the force is given by the left-hand rule.⁷ Applying the left-hand rule to conductor *a*, it is seen that the force on it is away from the reader, opposite to the direction in which the conductor is being driven, so that the wire is harder to push than it would be if there were no current. The greater the current in the conductor the greater must be the force exerted to drive it around, and therefore the greater must be the power developed by the prime mover in keeping up a given speed. The same reasoning applied to *b* shows that it acts with *a* in opposing rotation.

78. **Losses.**—Of the mechanical energy supplied to a generator by its prime mover, not all appears in electrical form in the circuit. Some is unavoidably transformed into heat, and thus lost for practical purposes. The losses, which may be called power losses or energy losses, may be classified as—

1. Mechanical losses.
2. Copper losses.
3. Core losses.

Mechanical losses are those due to friction in the bearings, friction at the brush contacts, and friction between the air and the moving part of the machine, commonly called windage. The latter is not important in low-speed machines, but becomes prominent in the case of very high-speed generators. Generators of the kind we are discussing are driven at nearly constant speed, so the mechanical losses do not depend much on the load, whether large or small. They do depend very greatly on the condition of the bearings and brushes. Some points regarding the care of machines in this respect are given at the end of this chapter, in Section 106.

Copper losses are due to the flow of current against the resistance of the field and armature windings. They are therefore divided into two parts, field copper loss and armature copper loss. The former is also called "excitation loss." Since

⁷ The thumb, forefinger, and middle finger, all at right angles, giving, respectively, the directions of motion, flux, and current. See Sec. 63, p. 153.

the field coils have resistance (usually high) some heat is produced as the necessary current for magnetization is made to flow through them. Like all heat losses due to current in a conductor, the heating is proportional to the square of the current, being in watts,

$$W = I_f^2 R_f \quad (67)$$

where I_f is the current in amperes in the field coils and R_f is the resistance of the whole field circuit.

To get the same terminal voltage at the armature, when the current in the latter is large, requires more magnetization than when the armature current is small. This in turn requires more field current, hence the field copper loss, or excitation loss, is somewhat greater at large loads than at small loads; that is, it varies somewhat with the load.

Like the field loss, the armature copper loss is of the $I^2 R$ type; it varies as the square of the armature current, and therefore as the square of the load on the generator. The armature resistance is made as small as is expedient. In a large generator it may be only a small fraction of 1 ohm, but the loss due to the great current generated will nevertheless be considerable.

Core losses, or losses in the magnetic circuit, are of two classes, due to "hysteresis" and "eddy currents." Hysteresis losses are caused by the rapid reversals of the magnetism of the armature core. Each molecule of the core may be regarded as a tiny magnet, and when the magnetization of the core is changed in direction the molecules have to be pulled around against their mutual magnetic attractions. It takes energy to accomplish this. In an electric machine there is a double reversal during each cycle. This makes many reversals per second and requires considerable power.

Eddy currents are little electric currents induced in the iron sheets of which the armature core is made up. The thinner the sheets the smaller are the currents; in fact, it is because of the eddy currents that the core has to be laminated.

Both hysteresis and eddy currents produce heat in the core, and in producing heat they use up power which has to be furnished by the prime mover. Therefore they are wasteful, and the designers of electric machinery plan to keep them as small

as possible. Core losses in transformers have been briefly discussed in Section 58, page 132.

No specific statement can be made regarding the magnitudes of the various losses described in the preceding paragraphs, because they depend on many factors, such as the size, the operating speed, and special features of design. But in order to give the reader some idea, it may be said, roughly, that at full load, for generators of the usual types, the mechanical or frictional losses may range from 6 per cent for a 1-kw. machine to 1 per cent for the 1,000-kw. size; the excitation loss, from 6 to 1 per cent; the armature resistance loss, from 4 to 1 per cent; and the core loss, from 4 to 2 per cent.

It will now be clear why the allowable power output of a generator has a limit. Usually machines are heavy enough to give a large margin of strength, but they can not well be made large enough to allow for the heat produced by severe overloads long continued. The increased current causes heat to be produced more rapidly, and the temperature rises. High temperature is injurious to the insulation. For example, it is found that cotton should not be continuously heated as hot as the boiling point of water. Cotton is the usual insulation for the copper wires used in machinery. If the insulation is spoiled, the current can follow other paths than those it should, and the machine is ruined.

79. Rating; Name Plate Data.—Practically all electrical apparatus, whether for alternating or for direct-current generator, motor, or other device, is designed for certain definite conditions of operation. It is standard commercial practice to attach firmly to every electrical machine before it leaves the factory a brass information tag called a "name plate." This usually gives the serial number by which the machine can be identified; tells the maker's name; states whether the machine is a generator or a motor; what is the maximum continuous power output; whether for direct or alternating current; if alternating, for what frequency and how many phases; at what speed it is to be operated; at what voltage; the maximum current for continuous operation. Some of these items are at times omitted, but most of them are essential. A person who wishes to become familiar with electrical machinery should form the habit of examining the name plate of every machine

to which he has access and note the differences in size, construction, and use.

It has been previously said that electrical power is measured in watts (or kilowatts, "kw.," when large). In a direct-current circuit watts are the product of volts times amperes. With alternating current something else has to be taken into account, and to get the average power we must multiply the volts-times-amperes by the "power factor."⁸ We might expect to find a.c. machines rated in watts or kilowatts, but if we look at the name plate of a generator we are likely to find the letters "kva." (kilovolt-amperes). That is, instead of actual watts the permissible output is expressed as a product of amperes times volts divided by 1000. The reason is plain, if we remember that the whole question of what an electric machine will stand hinges altogether on the heating.

The heating of the field coils and armature core depends upon the voltage generated, because that is determined by the strength of the magnetic field, which in turn depends on the current in the field coils. The heating of the armature conductors is determined by the armature current; whether or not that is in phase with the emf. makes no difference. The total heating, then, depends on the volts and the amperes, regardless of the power output, which may be large or small, depending on the phase relation between the two.

Direct-current generators are usually rated in kilowatts and, as just stated, alternating-current generators in kilovolt-amperes. Motors, either d.c. or a.c., are often rated in units of horsepower (1 horsepower=746 watts). When an a.c. motor is rated in horsepower, a particular power factor is, of course, assumed.

80. Efficiency.—The ratio of the useful output of a device to its input, is called its "efficiency."

In all kinds of machinery it is impossible to avoid some losses of power, so the output is less than the input and the

⁸ Power factor is, in fact, the number by which we must multiply volt-amperes to get true watts. (See Sec. 55.) It is commonly expressed in per cent. It can not be over 100 per cent and is usually less. It depends entirely on the sort of circuit that happens to be connected to the generator, since this as well as the generator itself controls the phase difference existing between volts and amperes.

efficiency is less than 100 per cent. It is lower for small electrical machines than for large ones, and for a given machine it varies with the extent to which the machine is loaded. Certain losses go on regardless of the load; those are the mechanical losses, field excitation, and core losses. Others increase with the load; the armature copper loss rapidly, some additional core losses and a portion of the excitation loss more slowly. When the output is small, most of the power input is used up in the constant losses, and the efficiency is low. With very large outputs the variable losses become excessive, again lowering the efficiency. For some intermediate load, usually not far from the rated load given on the name plate, the efficiency is a maximum. At full load, and for the usual designs, it may range from 80 per cent for a 1-kw. generator to 95 per cent for a 1000-kw. generator.

81. Regulation.—Electric generators are, with few exceptions, intended to be operated at constant or nearly constant speed. Assuming that the speed is constant, and that the field excitation is also constant, the generated voltage would likewise be constant, regardless of the current output, if it were not for certain disturbing influences. A generator operating under these conditions is often called a “constant potential” or “constant voltage” machine.

The current output depends on what is going on in the external circuit. In a city it might depend on the number of lamps turned on. In the case of a generator supplying energy to a spark gap, it would depend largely on the adjustment of the gap. The term “load” is commonly used in this connection. Sometimes it means the devices themselves, which are connected to the line, and sometimes the current taken by them. There is generally no trouble in knowing which is meant.

Suppose we have a certain voltage generated when the load is zero. Then, if the machine is made to supply current to a circuit, the voltage at its terminals will in general be lowered and the greater the current, the more will the voltage be reduced. The term by which the behavior of a generator is described in this respect is called the “regulation.” It is found by subtracting the voltage at full load from the voltage at no load, dividing by the full load voltage and multiplying by 100 to get the result in per cent.

Expressed as a formula—

$$\text{Regulation} = \left(\frac{V_o - V_f}{V_f} \right) \times 100 \text{ per cent.}$$

where V_o = voltage at no load and
 V_f = voltage at full load.

A small percentage regulation means that the voltage remains very nearly constant when the load is changed.

82. Armature Impedance and Armature Reaction.—There are two reasons why the voltage of a generator is lower when it is supplying current than when it is not supplying current, even if the speed is entirely steady and the direct current flowing around the field magnets is the same.

(a) The armature windings are bound to have some resistance and some reactance. It requires an emf. to send current through the armature, therefore. This emf., called the armature impedance drop, has to be subtracted from the emf. generated to get the emf. left to send current through the external circuit. The greater the current, the greater the armature impedance drop and the less the emf. left for the external circuit.

(b) The armature winding and core constitute an electromagnet. When current flows in the windings, the magnetic field caused by it is combined with the magnetic field due to field strength, with consequent decrease in armature voltage, since the resultant magnetic field is what determines the generated emf.

The change in the field flux by reason of the current flowing in the armature is called "armature reaction." Armature reaction occurs in direct current as well as in alternating current machines, and in motors as well as generators.*

83. Effect of Power Factor on Regulation.—The reduction of terminal voltage due to the current flowing in the armature depends not only on the magnitude of the current but also on its phase relation to the emf., which is indicated by the power factor. A lagging current causes a greater reduction in terminal voltage than the same number of amperes in phase, the effect increasing with the lag. Thus, at 80 per cent power factor

* Swoope, p. 362; Rowland, p. 230; Franklin and Esty, "Dynamoes and Motors," p. 256.

it may be twice as great as at 100 per cent. Conversely, a leading current, such as is taken by condensers, improves the regulation, so that the terminal voltage may actually be higher when current is flowing than when there is none.

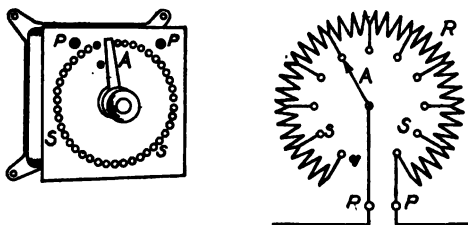

Fig. 109

Field Rheostat

Letters correspond in the two figures
PP - Binding posts *A* - Contact Arm
SS - Contact studs *R* - Resistance wire

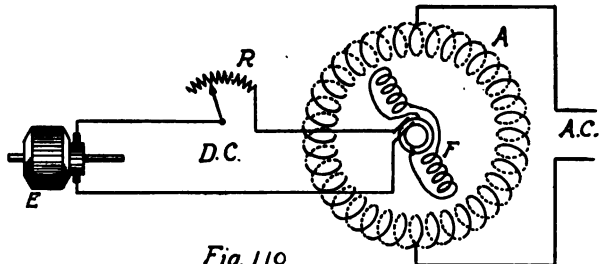

Fig. 110

Scheme of connections of Alternator.

E - Exciter Armature *F* - Alternator field coils
R - Alternator field rheostat *A* - Alternator armature.

84. **Effect of Speed on Regulation.**—Since the emf. is proportional to the rate of cutting of flux, it follows that fluctuations of speed are attended with proportional fluctuations of voltage, provided the field excitation is not changed at the same time.

85. **Voltage Control.**—The simplest way to control the voltage of a generator is by adjusting the strength of the magnetic field by means of the field current. For this purpose an adjustable resistance is inserted in the circuit of the latter, called a field rheostat.

One kind consists of a quantity of wire of an alloy having a comparatively high resistance, mounted on insulating supports in a perforated iron box with a slate face, or embedded in an insulating enamel. A handle is provided for making contact with any one of a number of brass studs attached to the resistance wire at various points, so that more or less of it can be in circuit. Terminals are provided for connecting the rheostat to the field circuit. Fig. 109 shows the principle.

The place of the field rheostat in the scheme of connections is seen in Fig. 110, which represents the stationary armature and revolving field of an alternator, with arrangements for supplying current to the alternator field from the exciter *E*, current being controlled by the field rheostat *R*.

Small alternators for field use in radio telegraphy are often used without a field rheostat. The voltage is kept steady enough for practical purposes by driving the machine at the right speed.

C. Direct-Current Generators.

86. **Commutation.**—Fig. 102, page 163, illustrates the principle used when alternating currents are generated by revolving an armature in a stationary magnetic field. But if each end of the loop is connected to a half cylinder of metal (*C*, Fig. 111), on which rests a stationary brush *B+* or *B-*, then as the loop is revolved the connection to the external circuit is reversed every half revolution, and the pulsations of current are always in the same direction. The reversing device is called a "commutator." The brushes must be so set that the reversal of connections occurs at the instant when the current in the loop is zero and about to reverse.

Thus in the figure, *a* is near the *N* pole, and if it is coming toward the reader the emf. will be toward the right. At that instant the current will flow out through the segment in contact with the upper brush to the external circuit; that is the upper brush is *+*. After a quarter revolution the conductors will be moving along the flux and not cutting across it, so

there will be no emf. Each brush will be just in the act of passing from one segment to the other.

After a half revolution from the position shown *b* will have exchanged places with *a*. Now the emf. in *b* will be toward the right, and current will flow out to the external circuit through *B+*. Thus the same brush is always positive. In the external circuit the current always flows in the same direction, though in the armature conductors the current is alternating.

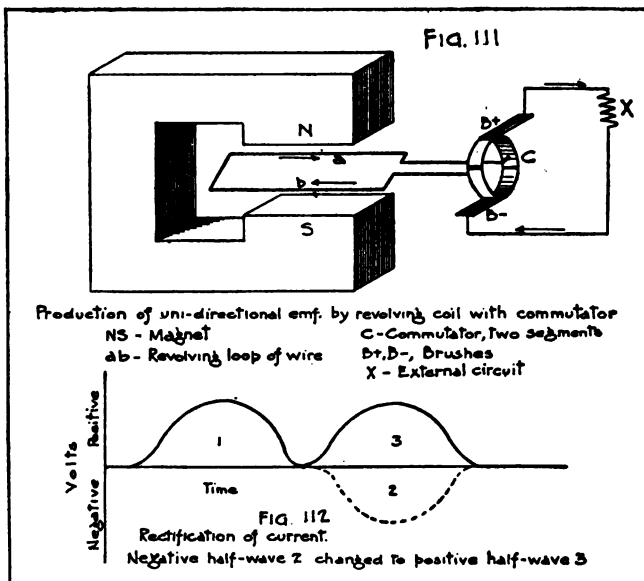

If an emf. curve similar to Fig. 95, p. 154, were plotted for this circuit, with time measured along the horizontal axis, and volts at any instant along the vertical axis, the result would be somewhat like Fig. 112. Instead of a positive and a negative half wave there would be two positive halves, the negative being rectified by means of the commutator.

Again, as with alternators, the need of higher emfs. than can be developed by a single loop and of more effective utilization of the material make necessary the use of coil-wound

armatures and multipolar field magnets. With a commutator consisting of only a few segments, say as many segments as there are magnet poles, the current would still be pulsating.

To get a steady, practically constant emf., commutators are used having many segments—several hundred in the case of large generators and motors, and usually not fewer than 20 or 30 even on very small machines for 110-volt circuits. Such a commutator consists of bars of copper, slightly wedge-shaped, separated by thin insulating sheets of mica, the whole assembled in the form of a cylinder held together by strong end clamps. The segments are insulated from the clamps by suitably shaped rings, usually of molded mica insulation. Connections leading to the armature conductors are soldered into slots in the segments, which commonly have lugs or “risers” for the purpose, extending upward at the end toward the armature.

87. Ring and Drum Windings.—Armature windings fall into two broad classes, called “ring” and “drum” windings, according to the way the conductors are mounted on the core. In the first of these the wire is laid on the outside and passed through the hollow space inside of the core, being threaded through and through much as a napkin ring or a bridle ring might be covered with string.

Ring windings are scarcely ever used nowadays. Modern machines have windings of the type shown in Fig. 113, called “drum” windings. The conductors are all on the outer face of the core, and the two branches of a turn lie under adjacent poles of opposite polarity. These two features are characteristic of all kinds of drum winding. In the kind illustrated in the diagram, starting with commutator segment 1, we pass up to conductor *b*, which at the instant shown is under a *S* pole. It is connected at the back of the armature to *t*, which lies under a *N* pole and is soldered into segment 2. Starting at 2, we have *d* under the edge of the *S* pole back-connected to *k* under the edge of the *N* pole; *k* is attached to segment 3. Continuing in the same way all around the armature we finally have 16 loops connected to the 16 commutator segments. It will be understood that an actual machine has a great many more turns in the armature winding and a larger number of commutator segments.

At the four segments marked + or - contact is made with brushes leading to the external circuit. By the "right-hand rule"¹⁰ the emf. in conductors under the *N* pole is toward the back end, so current flows into the armature at segment 3. The brush on that segment is therefore negative. The brush at segment 7 is positive, because there the current flows out of the armature. Similar reasoning applied to the conductors under the *S* poles leads to the same result as to polarity of

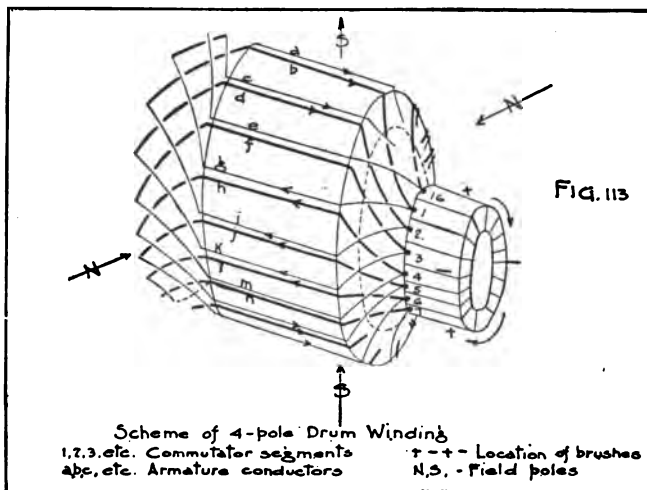

the brushes, which are thus seen to be alternately, one positive and the next negative, as we go around the commutator. If a machine having more than two sets of brushes is examined, it will be found that all the positive brushes are joined by a heavy conductor and all the negative brushes by another. Then one connection is made from the group of positive brushes to the external circuit, and one from all the negative brushes.

In speaking of alternators, the actual construction of armatures was described; that is, the use of machine-wound coils in slots in the face of a laminated core. D.c. armatures are made

¹⁰ See section 63, p. 153.

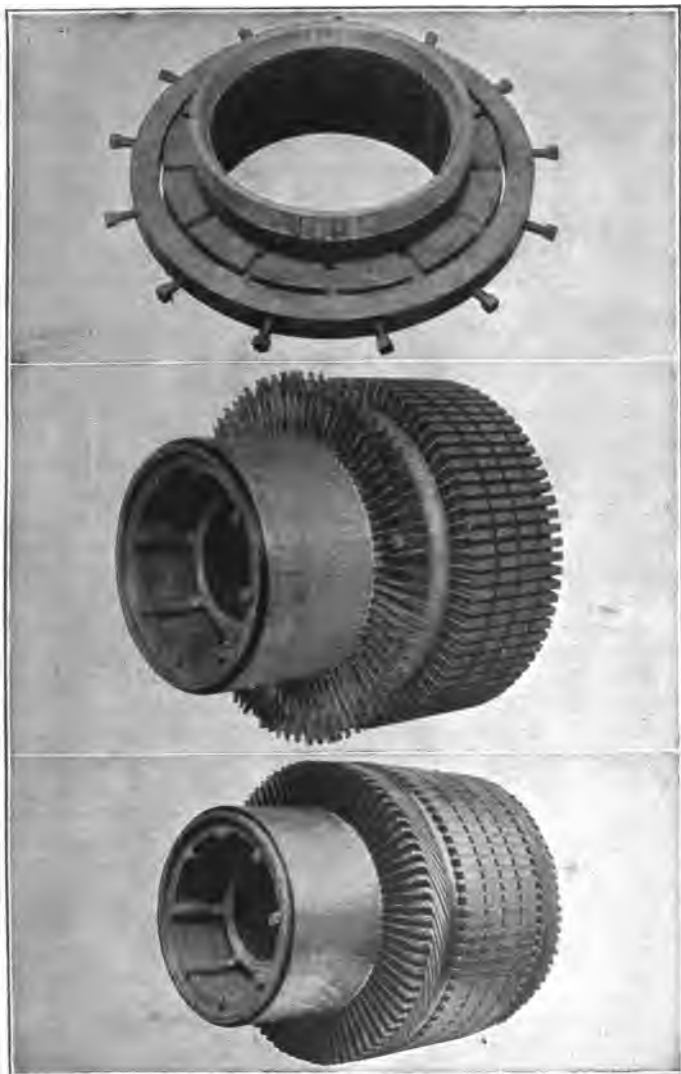

FIG. 114 (upper)—Method of assembling commutator segments. **FIG. 115 (middle)**—Commutator and armature core assembled showing risers. **FIG. 116 (lower)**—Armature complete with windings connected to risers.

the same way except that the ends of the coils are soldered to the commutator segments.¹¹

The main steps are shown in Figs. 114, 115, and 116. The first shows the copper segments, with their sheets of mica between them, assembled in the form of a ring and held together by a firm temporary clamp. The next picture shows the commutator fastened on the front end of the armature core. The "risers" are to be seen coming up from the ends of the segments for connection to the armature coils. On the core, built up of thin laminations, note the teeth, slots, and three rows of air ducts for ventilation. The last picture shows the coils in the slots of the core. Their ends have been soldered to the commutator.

88. Excitation: Separate, Series, Shunt, Compound.—While alternators require d.c. from a separate source for their field excitation, direct-current dynamos usually excite their own fields. Depending on the scheme of connections between the armature and the field coils, this gives rise to several arrangements, all of which are of practical importance. In this discussion we leave out of consideration the "magneto," which depends for its magnetic field on a group of permanent magnets.

Fig. 117 shows the several ways of exciting the field magnets, and incidentally illustrates the conventional symbols generally used for an armature and for field windings. In this sort of diagram no attempt is made to draw a picture of the machine. A whole set of field coils, for example, is represented by a single coil, the armature and brushes by a single circle¹² and two strokes.

Separate.—The first sketch indicates that current for the field coils comes from a source, like a battery, entirely independent of the armature. Such a machine is said to be "separately excited."

Shunt.—The next indicates that the current from the armature divides; some goes to the load circuit, some to the field coils; the two unite again and flow back into the armature at

¹¹ Brief information on the care of commutators and proper position of brushes is given at the end of this chapter in Sec. 106, page 227, on "Common Troubles."

¹² Note difference from alternator, which has two circles, representing slip rings.

the brush of opposite polarity. When the current from the armature divides, a portion flowing through the field winding, the machine is spoken of as a "shunt generator." Only a small fraction of the total current which a machine is able to generate continuously is required for shunt field excitation; it may be 5 or 6 per cent for a 1-kw. generator, and as little as perhaps 2 per cent for a 100-kw. generator.

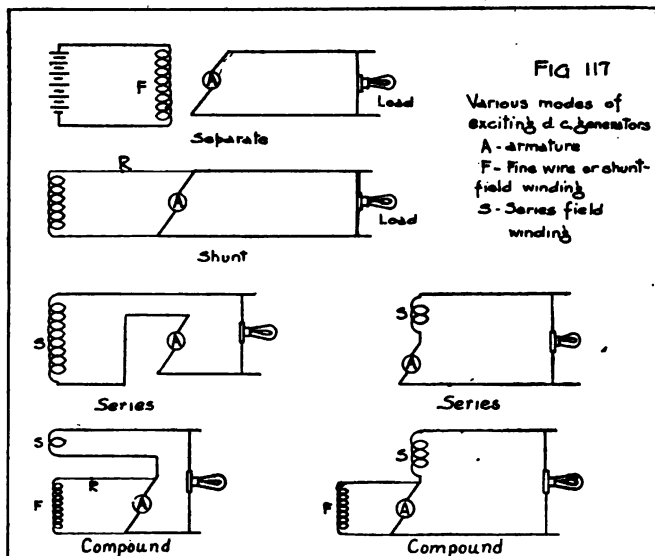

Shunt field windings consist of many turns of fine wire (insulated, of course). There may readily be 2000 or 3000 turns. For instance, the little exciter for the 500-cycle audio-frequency generator described on page 195 is a direct-current shunt generator. Each of its two field coils has 2800 turns of wire about 0.25 mm. (0.01 in.) in diameter. Using this great quantity of fine wire has two consequences; because of its high resistance it lets only a small current flow; because of the large number of turns this small current suffices to produce the desired magnetomotive force (which depends on the "ampere turns").

Series.—When the whole current from the armature flows through the field coils, the generator is “series excited.” Two ways of representing a series generator are shown in Fig. 117. Heavy wire is used for series coils. They have to carry the full current output of the machine; if fine wires were used, the excessive heat produced would destroy the insulation. The necessary ampere turns are secured by virtue of having a large number of amperes and comparatively few turns of wire.

Compound.—When a generator is provided with two sets of field coils, one of fine wires connected in shunt and the other of a few turns of heavy conductor connected in series with the armature, it is called a “compound wound” generator, or more commonly just a “compound” generator. Two ways of representing it are shown in Fig. 117.

89. Characteristics of Terminal Voltage.—Why are so many different kinds of connection used for field excitation? Ordinarily the load on a generator will vary. By this we mean that there are changes in the number of devices switched on; lamps may be turned on or off, or motors started and stopped. Such changes of load automatically affect the terminal voltage of the generator, but they affect it differently, according to the kind of field excitation used.

To see why the effects differ, in each case consider the dynamo driven at a steady speed without load. Then imagine the load (current through the armature) to be successively increased. If separate excitation is used a certain emf. is generated at no load. When current flows in the armature some of this emf. is used up in sending the current through the resistance of the armature itself. There is also another effect, due to “armature reaction,”¹⁸ which weakens the magnetic field. Both increase as the armature current increases. Hence the terminal volts are less when the armature current is large, than when it is small. Curve *a*, Fig. 118, shows this graphically. The load current in amperes is plotted along the horizontal axis, the terminal volts along the vertical axis. The greater the cur-

¹⁸Armature reaction is explained in Sec. 82 and in texts on electrical engineering (See Franklin and Esty, “Elements of Electrical Engineering,” vol. 1, p. 151; Franklin and Esty, “Dynamoes and Motors,” p. 176; Timble and Higble, “Alternating Current Electricity, First Course,” p. 394; Sheldon and Hausmann, “Dynamo Electric Machinery” (9th ed.), vol. 1, pp. 110–121.

rent, the lower the voltage. The difference between no load and full voltage shown in the diagram corresponds to a regulation¹⁴ of some 8 per cent, and applies to rather large machines, say of 100 kw. or more. For a smaller one the difference would be greater.

When shunt excitation is used the reduced terminal voltage sends a reduced current through the field coils, so the magnetic

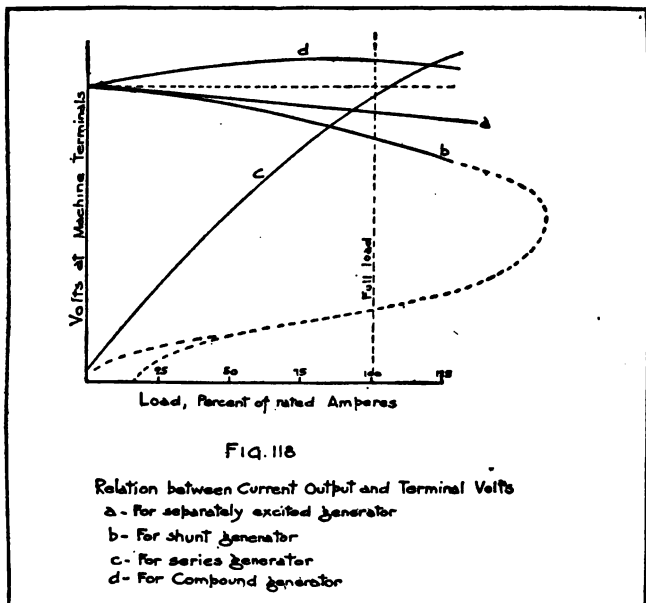

flux is weaker, the greater the armature current. Hence the terminal voltage falls off more than it does with separate excitation. Thus curve *b*, Fig. 118, droops more than curve *a*. The dashed part shows how the voltage falls off when the machine is greatly overloaded.

With series excitation, the condition is very different. When no current flows, only the weak residual magnetism of the iron is available, and the emf. generated is consequently very small.

¹⁴ Defined in Sec. 81.

Curve *c* shows it by starting only a very little above the zero value. If current is taken from the machine, this current, flowing in the field coils, strengthens the magnetic field and so causes a greater emf. to be generated. The greater the current taken by the external circuit, the greater will be the voltage. Hence curve *c* rises.

In the compound generator the two effects are combined. Depending on the relative proportions of the two windings, the voltage at full load may be made equal to that at no load, or greater, or less; the latter is rare. Curve *d*, Fig. 118, is for a generator somewhat "over-compounded." If the full load voltage were the same as the no load voltage, the generator would be "flat-compounded."

In examining a generator, it is usually impossible to determine whether the field coils are of fine or thick wire without tearing them open, because they are protected with wrappings of tape, hard cord, or other covering. To distinguish between shunt and series coils is, however, quite easy by looking at the connections. Those between the shunt field coils on the different poles are small because they have to carry only a small current, those between the series coils are heavy, consisting of thick, wide straps of copper on the larger generators.

90. Emf. Equation.—It has been stated that the emf. developed in a conductor depends on the rate of cutting the magnetic flux¹⁵ and is equal in volts to the number of magnetic lines of force cut per second, divided by 10^8 . On an armature a number of such conductors are connected in series and their emfs. are therefore added. Thus in Fig. 113, the conductors which would have to be traversed in going from one brush on the commutator to the next through the armature constitute one such group. There are three other similar paths, and these four paths are all in parallel, so the resulting emf. is the same as that of one path alone, but the current that goes to the external circuit is the sum of the currents in the four paths.

Let N = the number of conductors in series.

n = number of revolutions per second (not per minute)
of the armature.

p = number of magnetic poles.

ϕ = magnetic flux per pole.

¹⁵ Chapter 1, Section 45.

Then the flux cut per second by any conductor is $n \times p \times \phi$ lines. Dividing by 10^8 gives the average volts. If there are N conductors in series, the total emf. is

$$E = \frac{n \times p \times \phi \times N}{10^8} \text{ volts.} \quad (68)$$

This formula shows that the voltage of a generator can be changed by changing the speed n , the flux ϕ , the number of poles p , or the number of conductors N . The last two, of course, are fixed once for all when the machine is built; the first two can be changed quickly by the operator, and afford practical means of controlling the voltage.

This formula means exactly the same thing as the one given for induced emf. in Chapter 1, namely that $E = \frac{N\phi}{t}$. It is merely necessary to note that if $n \times p$ poles are passed per second, then the time required to cut the flux ϕ is only $\frac{1}{n \times p}$ th of a second; this takes the place of t in the denominator; or what amounts to the same thing as dividing by $\frac{1}{n \times p}$, we multiply by $n \times p$. The reason for the factor 10^8 in the denominator has been explained.

91. Voltage Control.—The practical way of controlling the voltage of separately excited, shunt, and compound generators is by having an adjustable resistance, called a "field rheostat" (Fig. 109), in circuit with the fine wire (shunt field) coils. The points R in Fig. 117, show where such a rheostat might be put in the circuit of each machine.

92. Effect of Varying Speed.—A rise or fall of speed causes the emf. of a separately excited generator to rise or fall in about the same proportion. In shunt and compound generators the effect is greater. That is why engines for driving such generators have to have good governors, if a steady voltage is wanted.

Because of these characteristics, each type of generator has its special uses. For instance, the exciter for the a.c. generator of a radio field set is a simple shunt generator, because the load does not change much. The shunt generator is good also for

charging storage batteries. Incandescent lamps need a very steady voltage that is not changed when some of them are turned on or off. A compound generator meets this requirement.

Voltage Regulators.—Various devices have been developed for maintaining the voltage of a generator constant with varying generator speed and varying conditions of load. A simple type used with a shunt generator is shown in Fig. 118-a. The shunt field winding of the generator is shown at *S*. The voltage regulator proper consists of an electromagnet with two windings *V* and *W*, a vibrating armature *A* normally held back

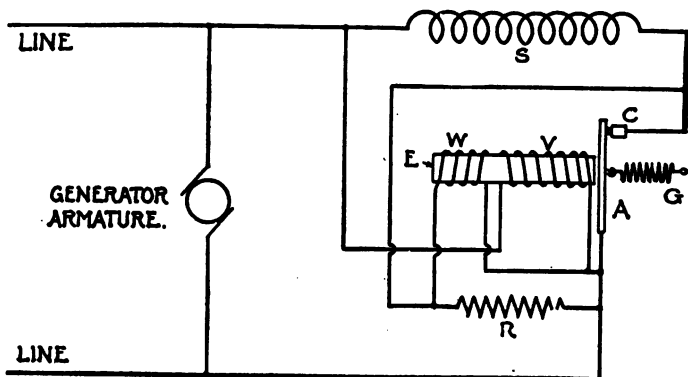

FIG. 118-a

VIBRATING VOLTAGE REGULATOR

by a spring *G*, and a noninductive resistance *R*. The two windings of the magnet are wound so as to oppose each other; the winding *V* is called the "voltage" winding, and may have more turns than the "reverse" winding *W*. The voltage winding *V* is connected across the voltage to be regulated, which is the voltage across the terminals of the generator. The tension of the spring *G* is adjusted so that when the line voltage is normal the armature *A* is just held against the contact *C*, and the shunt field is then connected directly across the line. If now the line voltage increases, the armature is pulled away from the contact *C*, and the current to the shunt field must pass

through the noninductive resistance R or the winding W . The current through the shunt field is therefore decreased, and hence the line voltage is decreased. If it were not for the winding W , the armature would be held over with the contact C open until the line voltage had dropped sufficiently so that the spring would pull the armature back. The reverse winding W , however, accelerates this action. Winding W is connected across the resistance R , and part of the shunt field current passes through W . The magnetic field due to the current through W opposes the magnetic field due to the current through the voltage winding V , and the armature is therefore pulled back and contact C closed more quickly. A little time is required for the current to build up in the inductive winding W , and the magnetic effect of the current through W lags a little behind the effect of introducing the non-inductive resistance R into the circuit. In operation this type of voltage regulator is continuously chattering, and gives good regulation. A voltage regulator of this type is now supplied with some generators used in Signal Corps sets. There are also various other kinds of voltage regulators in general use.

D. Special Alternators for Radio Use.

93. Audio Frequency and Radio Frequency.—Alternating currents are generated at various frequencies, covering a remarkably wide range. Depending on their application, the frequencies in practical use fall into three well-defined classes:

(a) *Commercial* frequencies, which nowadays generally mean 25 or 60 cycles per second.

(b) *Audio* frequencies, which are usually around 500 to 1000 cycles per second but may extend as high as 10,000 cycles per second.

(c) *Radio* frequencies, usually between 20,000 and 2,000,000, but extending in extreme cases down to perhaps 10,000 and up to three hundred million cycles per second.

Commercial frequencies are used for lighting and power. The great machines in the central stations which supply our cities with current operate at these frequencies.

Audio frequencies are those conveniently heard in the telephone. When alternating currents are sent through a telephone,

the diaphragm of the latter vibrates. The vibrations are heard as sound. The more rapid the vibrations, the shriller the tone. Vibrations at the rate of 4,000 or 5,000 per second give a shrill whistle, while the lowest notes of a bass voice have somewhat under 100. If a 500-cycle generator supplies current to a spark gap and the spark jumps once on the positive and once on the negative half-wave, then at the receiving station the signal is heard in the telephone as a musical tone of 1000 vibrations per second.

Radio frequencies occur in the circuits of radio apparatus, for instance, in an antenna. They are too rapid to cause a sound in a telephone which can be heard by the human ear. They may be generated by dynamo-electric machines of highly specialized construction, but are usually produced by other means.

94. Audio-Frequency Generators.—To show how the methods described in the preceding sections are applied in actual generators, a few typical machines used in radio sets will be briefly described. Whether or not these are of the latest design is not important. Changes of detail are constantly being made, but they do not affect the principles used and can be readily understood after the workings of similar machines have been grasped. The examples of machines here given will also illustrate how the form of generator and the auxiliaries used with it are influenced by the source of power available for driving it.

The generator is only one part of a unit for converting energy into the electrical form. The other part depends on the source of energy available; it may be heat derived from coal or gasoline; it may be falling water, moving air, human muscles, or a charged storage battery.

Crank Driven.—The field radio pack set furnishes an example of a self-contained generating unit driven by hand. These sets have been changed somewhat from time to time and can therefore be described only in a general way. The generator is cylindrical in shape and is entirely incased, including the ends, in a metal shell. At one end of it is a flywheel for equalizing the speed. At the other is the train of gears, running in oil and inclosed in a housing, through which power is transmitted from the crank shaft to the generator shaft. The crank shaft is turned by means of a pair of cranks.

The alternator¹⁶ is a 250-watt, 500-cycle machine of the revolving armature type. The exciter¹⁷ is built in with the alternator, so that the two have but one frame and one set of bearings, and the same shaft carries both armatures. Near one end, on opposite sides of the shell, is a pair of holes giving access to the d.c. brushes which bear on the commutator of the exciter¹⁸ and near the other end are similar holes for the a.c. brushes that bear on the collector rings. The crank is turned at the rate of 33 to 50 r.p.m., depending on the machine (that is, the date of the model), and the generators make 3,300 to 5,000 r.p.m., the cranks being geared to them at a ratio of 1 to 100.

The diagram and data of Fig. 103 apply to the alternator of such a set, the armature having 18 teeth, the same as the number of field poles. To get 500 cycles it must make 3,333 r.p.m. which corresponds to a crank speed of about 33 r.p.m.

The connections are shown in Fig. 119. The field coils of the exciter are connected directly to the brushes. The circuit to the alternator field coils passes through a receptacle P_1 on the side of the machine. A two-wire cable can be plugged in at this point for the sending key. While the key is closed, field current flows and a.c. is generated in the armature. Another receptacle P_2 provides for connecting the alternator armature to the transformer from which current is supplied for the spark.

In view of the high speed at which these generators run (some make 5,000 r.p.m.) the brushes have to fit very smoothly and the bearing surfaces, particularly the d.c. commutator, have to be in good condition. For ease of turning, they should not be pressed in harder than necessary; on the other hand, unless the contact is good the set fails to operate satisfactorily. The most common troubles, electrically, are due to a dirty commutator, poor brush contacts, or to turning the brushes in replacing them, so that the curve of the brush does not match the curve of the commutator.

Gasoline-Engine Driven.—Hand power is not practical, except for very small generators, since a man can develop only about

¹⁶ See Fig. 103, page 164, and foot note, page 165.

¹⁷ A little generator of d.c. for the field coils of the alternator. See Sec. 71.

¹⁸ The commutator is described in Sec. 86.

one-tenth of a horsepower if he has to keep it up for more than a short time. One of the most convenient sources of larger power is the gasoline engine. It is particularly suitable for isolated stations, or for the more powerful portable sets, like the field radio tractor sets. Detailed information about any particular set is supposed to be furnished with the set, but certain features are likely to be common to all.

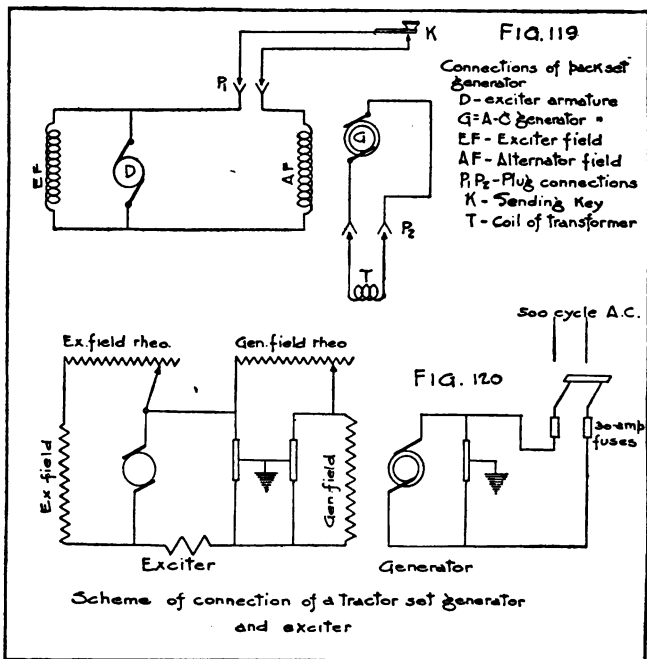

The speed of rotation of the alternator is almost always much higher than that of an engine; it is therefore stepped up by pulleys and belts, or sprockets and chain, or gears, the smaller pulley or sprocket or gear being on the generator shaft.

The generator may be of any of the three possible types previously described; for example, one of the permanent Signal Corps stations uses an inductor alternator (Sec. 74); one kind

of tractor set also has the inductor type; another has the revolving armature. If it becomes necessary to open the machine it is easy to discover which type it is. If the rotor, or revolving part, has no windings at all, then we are dealing with an inductor alternator; if the circuit leading to the transmitting apparatus (not necessarily the key, because that may be in the field circuit) comes from the slip-rings, then the revolving part must be the armature.

In one of the sets of this latter type the alternator and its exciter are two separate machines, connected by a coupling so that both revolve together. A frequency indicator in front of the chauffeur guides him in controlling the speed of the engine so as to maintain the right frequency—500 cycles per second. The combination is chain driven from the main transmission. The same engine that drives the truck is used to furnish power for the generator, the one or the other being thrown in as desired.

The following name-plate data of this particular set will illustrate some of the statements made in earlier sections:

Generator frequency, 500 cycles; poles, 30; kva., 2.5; open circuit volts, 245; terminal voltage at full load, with key closed, 110; 2 kw. at 0.80 p. f.; 2000 r. p. m.

Exciter, shunt type: poles, 2; load volts, 110; load amperes, 2.7; 0.3 kw.

From the speed, 2000 r. p. m., and the stated number of poles, 30, each revolution gives 15 cycles and the cycles per second will be $\frac{15 \times 2000}{60} = 500$, which checks with the figure given.

From the full load voltage, 110, and the rating, 2.5 kilovolt-amperes or 2500 volt-amperes, the full load current is $\frac{2500}{110}$ or 22.7 amperes. The product of volts, amperes, and power factor gives power in watts, thus $110 \times 22.7 \times 0.80 = 2000$ watts, 2 kw. The great difference between the volts on open circuit, 245, and volts when loaded, 110, shows that the armature has a high impedance. It must not be assumed that this loss of voltage is all due to resistance, and so represents a waste of power. Much of it is due rather to the demagnetizing action mentioned in Section 82, which causes a reduction in the effective magnetism, and therefore in the emf. generated.

The scheme of connections in Fig. 120 shows that the exciter voltage can be controlled by means of the exciter field rheostat. This, in itself, would govern the 500-cycle voltage fairly well, but a second control is provided in the generator field rheostat. High-resistance connections between each machine and the ground provide a leakage path for high voltage charges and prevent their accumulation.

Fan Driven.—Audio-frequency generators have an important application in furnishing current for communicating from air-planes. Fan motors have been used as a source of power, though it has been objected that they increase the head resistance of the plane. There is no theoretical reason why any type of self-contained generator might not be used, but because of the high rotative speeds obtainable with fans and the need of lightness, special machines have been developed with the fan mounted directly on an extension of the shaft. One recent form is described on page 203.

Motor Driven, by A.C. Motor.—When electric current is to be had, but not at the desired frequency, use may be made of a combination of a motor, adapted to the circuit that is available, and a 500-cycle generator. Such a combination is called a "motor-generator set." For use with 110-volt, 60-cycle alternating current, sets are built using the same sort of generator (with built-in exciter) described in connection with hand-driven apparatus. Mounted on a common bedplate with it is an a.c. motor. The shafts are connected by a flexible coupling.

Except for the mechanical connection between the shafts, the two machines are entirely independent. Electrically there is no connection. The motor is designed to run automatically, at the proper speed for the generator, or perhaps it would be better to say that there are certain definite speeds at which 60-cycle a.c. motors have to run, and the generator has such a number of poles that it gives the desired frequency when driven by a motor operating at one of these speeds. Voltage control of the generator is secured by means similar to those shown in Fig. 120.

Motor driven, by D. C. Motor.—When direct current at 110 volts is available the arrangement is somewhat different. The exciter is unnecessary, because current for the field coil of the alternator may be taken directly from the line. It is then

possible to combine the generator and a 110-volt, direct current, shunt motor (see Sec. 97) into a very compact unit. The two armatures are on the same shaft and the two frames are joined in one structure.

Fig. 121 represents such a unit, which is shown partly disassembled in Fig. 122. The generator happens to be of the same

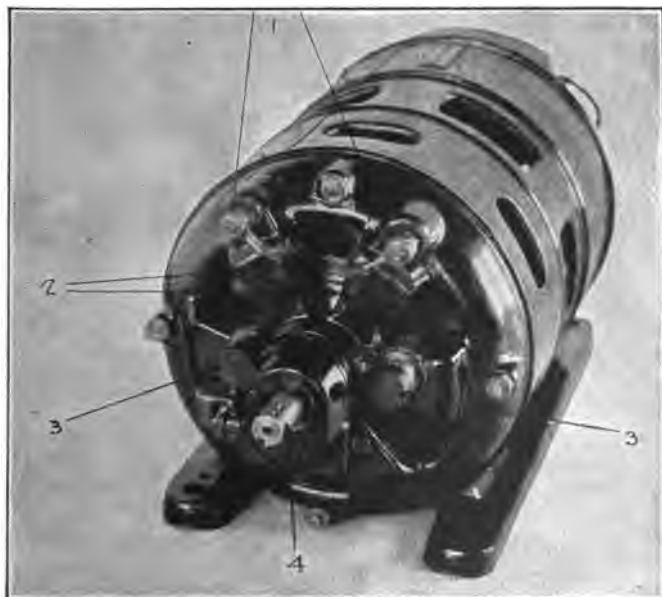

FIG. 121.—Small 500-cycle motor-generator set (2500 r.p.m.; 24 poles on stator; 24 teeth on rotor; 110 volts; 3.2 amp.; 0.35 kva.).

- | | |
|---------------------|-------------------------|
| 1. Field terminals. | 3. Armature terminals. |
| 2. Collector rings. | 4. Shaft of both units. |

design as that shown in diagram in Fig. 103, but being built for nearly 50 per cent more power it is somewhat larger, has more poles, and runs at a correspondingly lower speed to give the same frequency. The two armatures are seen on their common shaft; the collector rings are near one end and the commutator near the other.

One scheme of connections for such a unit is seen in Fig. 123, which shows the d. c. motor connected to its line by way of a switch and starting box.¹⁹ The rheostat shown in circuit with the motor field, *MF*, may be omitted. Its purpose is to give control of the motor speed,²⁰ if such control is desired, in order to get some definite frequency quite accurately in the a. c. circuit. From the d. c. line, connection is made also to the generator field winding, the flow of current being controlled by another rheostat which determines the magnetization and, therefore, the generator voltage. Thus the generator frequency may be governed by means of the motor field rheostat and the voltage by the generator field rheostat.

Motor-Driven Inductor Alternators.—Thus far in this part of the chapter attention has been centered on revolving armature generators. It is equally feasible to generate 500-cycle current by means of inductor alternators. Fig. 124 represents a motor-driven inductor alternator for conversion from direct to alternating current at 500 cycles. The table following gives the data as taken from the name plate.

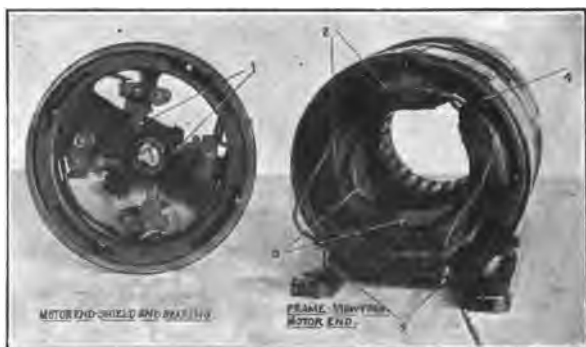

FIG. 122.—Motor-generator set of Fig. 121 partly dismantled.

- | | |
|--|---|
| <ol style="list-style-type: none"> 1. Motor brushes. 2. Motor field windings. 3. Motor field poles. | <ol style="list-style-type: none"> 4. Motor field yoke. 5. Terminals of motor field windings. |
|--|---|

¹⁹ Described in Sec. 97. ²⁰ How this is done is explained in Sec. 97.

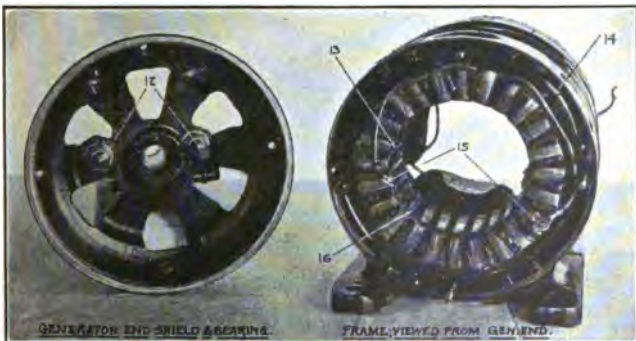

FIG. 122 (continued).—Motor-generator set of Fig. 121 partly dismantled.

- | | |
|--|--|
| <p>6. Motor armature core.
 7. Commutator.
 8. Generator armature windings.
 9. Generator armature core.
 10. Collector rings.
 11. Motor armature windings.</p> | <p>12. Generator brushes.
 13. Generator field windings.
 14. Generator field yoke.
 15. Terminals of generator field
 - windings.
 16. Ventilating fan.</p> |
|--|--|

Name plate data for motor-generator shown in Fig. 124.

	D. C. motor.	A. C. gener- ator.
Volts.....	120	125
Amperes.....	7.3	5
Revolutions per minute.....	2500	2500
Rating.....	1 h. p.	0.625 kva.
Shunt field amperes.....	0.4	
Cycles per second.....		500

Here again the two distinct machines, motor and generator, are combined in a single compact unit. The armatures are on

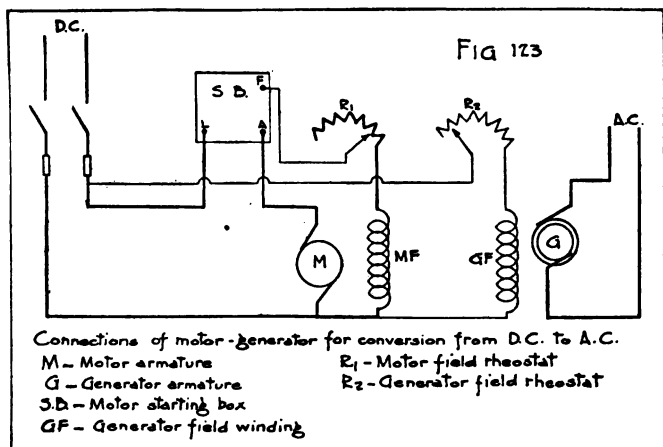

one shaft and the two frames are made into one structure, though openings are left for ventilation. These, as well as other openings at the ends of the machine, are screened to keep out foreign material, while permitting a free flow of air for cooling. The generator frame is cast in the form of a cylindrical shell. At each end is inserted a laminated armature core, with teeth projecting radially inward, on which the armature winding is placed. Between the two armature cores is the field winding, a single large coil which fits inside the cylindrical shell, where it is rigidly held in place. This coil produces a

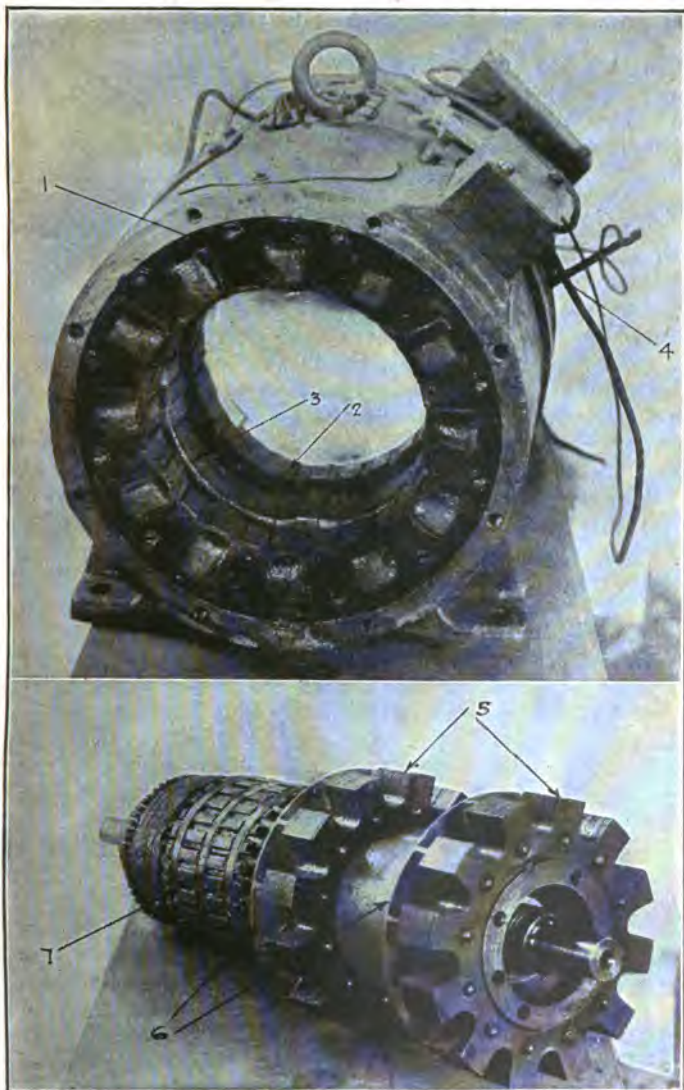

FIG. 124.—Inductor alternator type motor-generator set.

- | | |
|--|--|
| <p>1. Generator armature coils, first row.</p> <p>2. Generator armature coils, second row.</p> <p>3. Generator field coll.</p> | <p>4. Terminal box.</p> <p>5. Inductor teeth.</p> <p>6. Brass disks.</p> <p>7. D. c. motor armature.</p> |
|--|--|

magnetic flux parallel with the shaft. The armature winding is in two groups, one on each core. Each group consists of 12 coils, and the coils are all connected in series.

The portion of the set so far described is stationary. The rotor is a solid cylindrical core, at each end of which is a ring of 12 teeth projecting radially outward. The core is magnetized by the stationary field winding previously mentioned. To trace the magnetic circuit, begin at the core. One end of it is *N*, the other *S*. The flux passes out through all the rotor teeth at the *N* end, across the air gaps, into the adjacent stator teeth, through the corresponding gap into the rotor teeth at the *S* end, and thence into the central core again. As the rotor is made to revolve, the teeth are alternately in line with the armature coils, then opposite the spaces between coils. The flux through the coils consequently pulsates, and alternating emfs. are induced.

So far as the diagram of connections is concerned, Fig. 123 applies to this case quite as well as to the preceding one, for the shunt motor and generator field are supplied with direct current in either event, and alternating current flows from the alternator armature, whether that be revolving or stationary.

Self-Excited Inductor Alternator.—A very novel construction has lately been worked out for fan drive on airplanes. A simplified diagram of it is given in Fig. 125, from which the electrical and magnetic circuits may be traced, and the principle of its operation may be followed. For the moment, ignore the windings on the rotor. The machine is then seen to be an inductor alternator. The a.c. winding is on the 16 stator teeth, each tooth and its adjacent slot spanning $\frac{1}{4}$ of the circumference. These teeth, in groups of 4, form four polar projections.

The polar projections are made to have opposite polarities around the stator, so that there are two *N* and two *S* poles, by means of direct current sent through the field coils *F*, each of which consists of a large number of turns. The field coils are all connected in series to the source of direct current, to be mentioned hereafter, but the connections are omitted from the sketch to avoid having so many lines.

When the rotor is made to revolve, the flux through the stator teeth pulsates, and alternating emfs, are induced in the coils encircling them. By symmetry, whatever happens in any one coil is also going on at the same time in eleven others. The

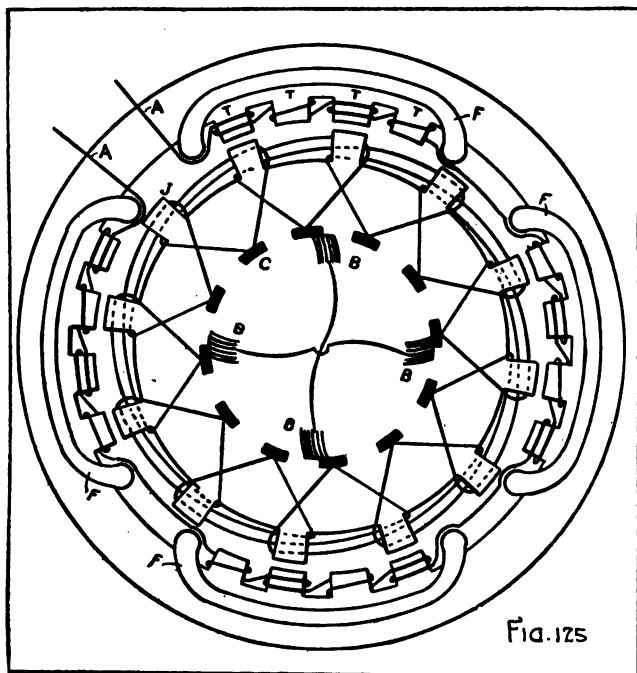

FIG. 125.—Self-excited inductor type alternator. (4500 r.p.m.; 75 volts; 5 amp., 900 cycles per second.) A, terminals of a.c. winding; B, brushes for taking d.c. from commutator; C, commutator segments; F, d.c. field coils; J, inductors; T, stator teeth.

passage of the inductor across a pair of consecutive, oppositely wound teeth gives rise to one cycle. The generator here represented is intended for operation at 4500 r.p.m. and at that speed, with the 12 inductors as shown, gives a frequency of 900 cycles per second.

Besides having on it the inductors for the alternator, the rotor also functions as a d.c. armature. That accounts for the windings shown on the rotor. How such an armature generates direct currents is explained in Section 87. For present purposes it suffices to say that the armature consists of a large number of turns, wound, of course, for four poles; each turn spans three teeth. In the diagram the connections have been simplified for purposes of illustration, and the number of commutator segments shown is much smaller than on the actual machine. Connections, not shown in the figure, are made between the field coils and the four brushes, two positive and two negative. The brushes are shown in the diagram on the inside of the commutator, for clearness; actually they are on the outside. The direct current from this armature is what energizes the field coils.

It will thus be seen that the rotor serves two entirely distinct purposes:

1. It carries the inductors for the a.c. generator, which has stationary field and armature coils.
2. It carries the d.c. armature, which corresponds to the exciter in other machines.

95. Radio-Frequency Generators. Alexanderson High-Frequency Alternator.—It is possible to construct an alternator of the inductor type which will directly generate a frequency as high as 200,000 cycles per second. In order to secure this frequency, it is necessary that 200,000 inductor teeth pass a given point every second. This result can be attained only by having a great many teeth on the rotor and driving it at a very high speed. In a 2-kw., 100,000-cycle generator the rotor has 300 inductors and makes 20,000 r.p.m. With a rotor having a diameter of about 1 foot, this design allows about one-eighth inch for each slot and tooth together, and even with this design the peripheral velocity of the rim is approximately 12 miles per minute.

The rotor consists of a steel disk with a thin rim and a much thicker hub shaped for maximum strength. Instead of having teeth on the edge, slots are cut on each side of the rotor very near the edge and may not extend entirely through the rotor disk. The spokes of steel which remain form the inductors, and a solid rim of steel is left. To cut down the friction of the

air at the high speed at which the disk is operated, the slots are filled with a non-magnetic material such as phosphor bronze, finished off smoothly with the face of the disk.

The armature conductors are laid zigzag in small straight open slots in the flat face of the stator core, this face being perpendicular to the shaft. Fig. 126a shows a cross section of a part of a small Alexanderson alternator. *C* is the rotor disk, and *A* the field windings. The armatures are shown at *B*, and

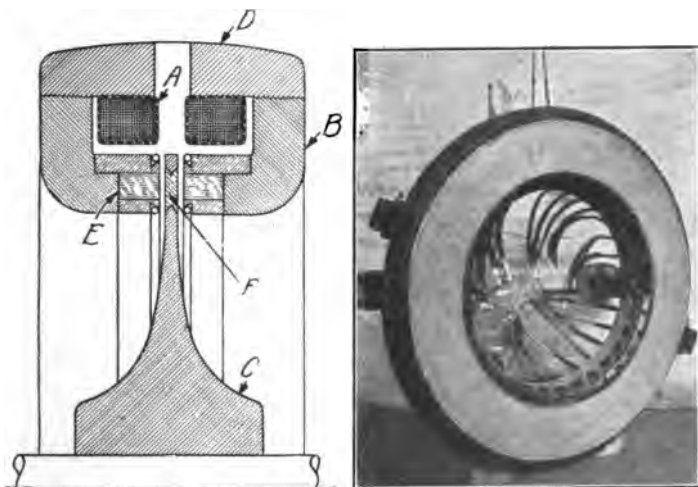

FIG. 126a (left).—Section of Alexanderson alternator, showing rotor.
FIG. 126b (right).—Front view of armature used in 200 kw. Alexanderson alternator.

the armature conductors, which are carried in laminations, at *E*. The field flux passes through the iron frame *D*, the laminated armature, and the disk. The slot filled with non-magnetic material is shown at *F*. The usual air gap is 0.015 inch, so that a very slight defect in construction will cause a serious accident.

In the radio station at New Brunswick, N. J., there is an Alexanderson alternator having a rated output of 200 kw. generated at a frequency of about 22,100 cycles per second when the alternator is running about 2,170 r.p.m. Similar alterna-

tors are in use at Tuckerton, N. J., and Marion, Mass. In this alternator the rotor disk runs between two laminated armatures, which are cooled by water circulation. The rotor disk of the type of alternator used at New Brunswick is shown in Fig. 126c; this rotor weighs about 5,500 pounds. Fig. 126b shows one-half of the armature of an alternator of this type complete and shows the leads from the terminals of circuits embedded in insulation. In this half of the armature there are 32 armature windings, and each circuit generates about

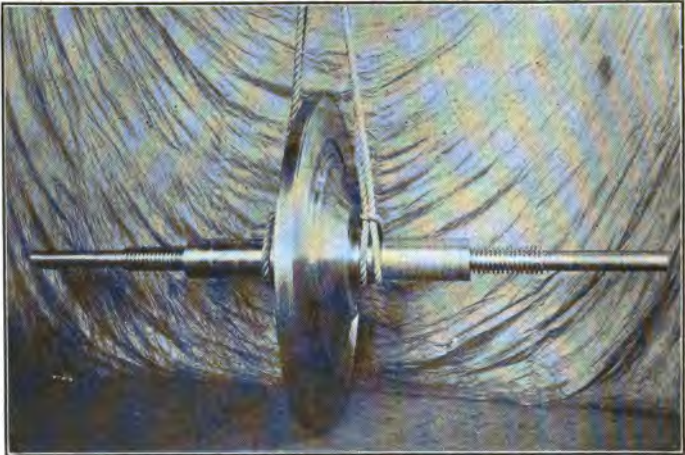

Fig. 126c.—Rotor of 200 kw. Alexanderson alternator.

130 volts on open circuit and carries a current of 35 amperes under normal load. In the complete armature there are 64 windings, and the current generated by these 64 windings is collected in an air-core transformer which has 64 independent primary windings, and the single secondary winding delivers the entire output of the alternator. The voltage at the terminals of the secondary winding when the alternator is operated at normal speed is about 2,000.

The construction of the high-frequency alternator requires many refinements in alternator design and very fine workmanship. Since a slight defect may have serious consequences, very careful operation of these alternators is essential. The use of

the high-frequency alternator in radio communication is described in Section 173. For further information regarding the Alexanderson alternator the reader is referred to: E. F. W. Alexanderson, *General Electric Review*, volume 16, page 16, January, 1913; *Proceedings A. I. E. E.*, volume 38, page 1077, October, 1919; *Proceedings Institute Radio Engineers*, volume 8, page 263, August, 1920; *General Electric Review*, volume 23, page 794, October, 1920; E. E. Bucher, *General Electric Review*, volume 23, page 814, October, 1920; A. N. Goldsmith, *Radio Telephony*, page 117; and to United States Patents Nos. 1008577 and 1110026.

French Designs of High-Frequency Alternators.—Bethenod and other French engineers have designed high-frequency alternators in which the practical difficulties of making the very small slots are lessened by utilizing several alternators mounted on one shaft to do the work of one, and in each alternator there are placed only a fraction of the needed poles. Thus, if three alternators are used, in passing around the periphery the successive poles are found by passing from one alternator to the next, and two of every three poles are omitted in each alternator. The pole of each alternator is displaced with reference to the corresponding poles of the other two alternators a distance of one-third of the pole pitch. The space left by the missing poles permits placing the coils more easily. Modifications permit simplifications in construction, so that the assembled unit does not really consist of three separate units. A description of this type of alternator is given in a paper by M. Latour, *Proceedings Institute Radio Engineers*, volume 8, page 220, June, 1920. Two 500 kw. alternators of this type are being installed in a new high-power station under construction at Sainte-Assise, near Paris.

Goldschmidt Alternator.—A principle not previously mentioned in connection with electrical machinery is utilized in the generators of certain German high-power stations. Advantage is taken of the building up of large currents by electrical resonance (see Sec. 109) in the rotor and stator circuits of the machine itself, as well as of the multiplication of frequency by the interaction of the currents in the stator and rotor windings on each other. These alternators differ from the Alexanderson alternator in that the high frequencies are not directly gen-

erated, but are built up in circuits associated with the alternator, which are often called "reflector circuits." A very brief description of this type of alternator will be given here. For detailed information the reader is referred to A. N. Goldsmith, *Radio Telephony*, and to papers which have recently been published in German periodicals devoted to radio communication. (See also Bureau of Standards Circular 74, p. 224.)

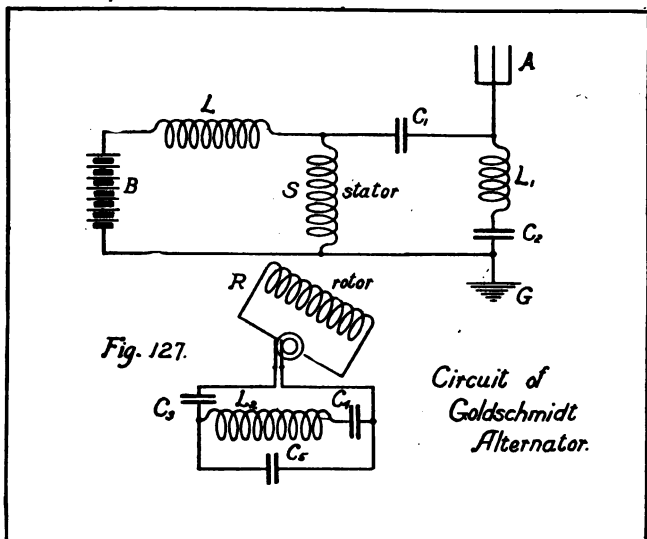

Without undertaking to give the proof here, it may be stated that when a rotor is revolved, and at the same time alternating currents are made to flow in the rotor at a frequency corresponding to the speed of rotation and to the number of poles, then, due to these currents, pulsations take place in the strength of the magnetic flux of the machine at double the frequency of the alternating currents.

The circuits (in simplified form) are shown in Fig. 127. Imagine *S* to be the stator winding, energized by some source of direct current, such as a battery *B*. In the magnetic field due to the stator there is revolved a rotor, represented by the coil *R*.

Suppose it is revolved at such a speed that the alternating emf. induced in R has a frequency of 10,000 cycles per second. By way of the slip-rings this emf. is impressed on the circuit $C_1L_1C_2$, which is tuned (Section 110), so that, when the inductance of R is taken into account the natural frequency is the same as that of the emf. Then heavy currents will flow in the rotor.

According to the statement made above, pulsations will take place in the magnetic flux at the rate of 20,000 per second. These will induce a 20,000-cycle emf. in S . If the inductances and capacities $SC_1L_1C_2$ are chosen for resonance at that frequency, large currents will flow in the stator at the same time with the steady current from the battery. These high-frequency currents are prevented from flowing through the battery by the high inductance L .

The 20,000-cycle stator currents cause a 20,000-cycle pulsation of the magnetic flux in which the rotor revolves, and when the rotor revolves in this pulsating field it gives rise to a triple-frequency emf.; that is, 30,000 per second in the illustration chosen. The condenser C_3 has such a capacity that the circuit RC_3C_4 resonates to that frequency, and the 30,000-cycle currents in the rotor, in view of the rate of rotation of the latter, cause a 40,000-cycle pulsation of magnetic flux with respect to the stator windings. That in turn induces a 40,000-cycle emf. in S . Remembering that the antenna A and the ground G constitute a condenser (see Sec. 137), which has the same relation to the stator circuit that C_3 has to the rotor circuit, it is seen that by proper tuning the circuit SC_4AG can be made to resonate at the final frequency.

Thus by providing suitable circuits, it is possible to get a frequency four times as great as that corresponding to the actual speed and number of poles of the machine.

The principle has been explained as though the machines were bipolar. Clearly, that would necessitate extraordinary speeds. Instead, the large generators used in transatlantic service have 360 poles and are driven at 4000 r. p. m. by 250-h. p. motors. The fundamental frequency is therefore 12,000, which is quadrupled as has just been explained, giving 48,000 at the antenna. To secure satisfactory operation the finest sort of workmanship is necessary in building them.

The Goldschmidt alternator which has just been described has inside of the machine a means for stepping up the frequency. The Goldschmidt machine, in units suitable for high-power stations, usually operates at a speed of about 4,000 r. p. m. An alternator of the Goldschmidt type was formerly in use at Tuckerton, N. J. The use of the Goldschmidt type of machine is at present decreasing.

Telefunken Alternator.—The “Telefunken” type of high-frequency alternator is at present extensively used in Germany, and an alternator of this type was installed at Sayville, Long Island. In the Telefunken type, the device for stepping up the frequency to two to four times the generated frequency is a separate unit outside of the machine, and is somewhat similar to a transformer in construction. Telefunken alternators of a size suitable for use at high-power stations usually operate at a speed of about 1,500 r. p. m., and this slower speed as compared with the speed of the Goldschmidt machine is an important advantage. For further information regarding the Telefunken alternator and the device for stepping up the frequency which is used with it, see A. N. Goldsmith, “Radio Telephony,” and L. B. Turner, “Wireless Telegraphy and Telephony.”

E. Motors.

96. *Uses of D. C. and A. C. Motors.*—It has already been noted that an electric motor is almost identical with a generator in structure, but its function is reversed; it converts electrical power into mechanical power. It is important to have the motor suited to the kind of circuit on which it is to be used; a. c., or d. c., the right voltage, etc. Common voltages are 110 to 120; 220 to 240; 500 to 550; also, for a. c., 440. Lower voltages are used on battery circuits. A. c. motors, like generators, may be single phase, two phase, three phase, etc.; and d. c. motors may have series, shunt, or compound excitation.

97. *D. C. Shunt Motor.*—If a shunt generator is used for charging a storage battery and the engine is shut off, the generator will continue running, provided the battery is large enough, but an ammeter in the circuit shows that the current has reversed. The battery is discharging and the generator is running as a motor. The action is explained by the fact that

when a current is sent through a conductor in a magnetic field there is a force that tends to push the conductor across the field (see Sec. 43). The left-hand rule gives the directions.

Consider the simple loop in Fig. 128, between the poles *NS* of an electromagnet. If the wires $+$ and $-$ are connected to a source of direct current, the iron will be magnetized. At the same time current flowing in the direction of the arrows in the loop causes a force toward the front in the conductor near the *N* pole and a force toward the back in the conductor near the *S* pole. The loop turns. The effect of the commutator is

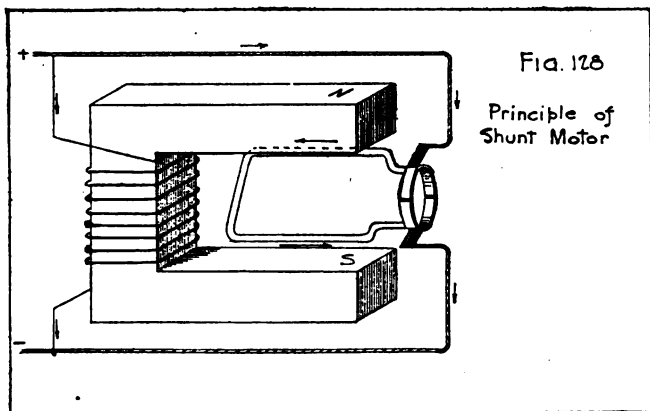

to make the rotation continuous by making the proper connection to the conductors as they come into place.

By a line of reasoning very much like that for the d. c. generator, we can pass from this simple case to that of a four-pole drum-wound motor, illustrated in Fig. 129. The directions of current and rotation are shown by arrows.

Limiting Speed.—It might be expected that a shunt motor would speed up indefinitely, but actually it soon comes to a definite speed, and then continues to turn so fast, but no faster. As soon as the armature begins to rotate, it generates an emf. according to the right-hand rule.²¹ This action is exactly the same as in a generator.

²¹ See Section 63, page 153.

The emf. generated is opposite to the direction of current shown by the arrows, and is for that reason called a "counter electromotive force." The faster the armature turns the greater the counter emf. becomes. It cannot turn so fast that the counter emf. is as great as the line voltage, because then

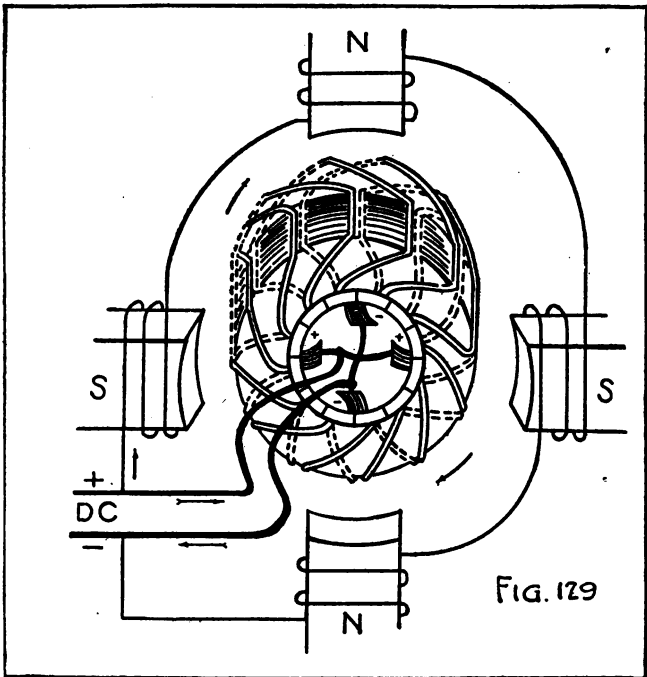

FIG. 129.—Diagram of circuits of a 4-pole shunt motor.

the two would balance; there would be nothing to make the current flow through the armature, and consequently no pull to keep it turning. For example, suppose the armature resistance of a certain motor is 0.25 ohm, and suppose that a current of 4 amperes in the armature furnishes just enough pull to keep it rotating. If the speed is high enough to make the counter

emf. 109 volts when the line voltage is 110, the current is 4 amperes.²²

Next, suppose the motor is driving machinery that calls for five times as great a pull. The speed falls off a little. When it has fallen enough to make the counter emf. 105 volts, the current is 20 amperes.²³ If that is enough to drive the load, the speed will be steady at the new rate. So by changing its speed a very little the motor automatically takes more or less current, but always just enough to drive its load.

The magnets are always of the same strength, regardless of load, because the current around them depends only on the line volts and the resistance of the field coils. It is entirely independent of the current in the armature.

Comparison of Generator and Motor Actions.—In both generator and motor we have an emf. developed in the armature by rotation in a magnetic field. Also in both we have currents which cause a pull on the armature conductors. If the machine is to act as a generator, its armature must be driven at such a speed that its emf. is higher than the voltage at its terminals, due to emfs. in other parts of the circuit. Then current flows with the emf. This current causes a back-drag on the armature and makes it harder to turn. If the machine acts as a motor, its emf. is lower than that of the circuit to which it is connected. The current flows against this motor emf., now called a counter emf., and causes a forward pull on the armature which keeps it turning.

Starting Box.—The resistance of a motor armature is small. The counter emf. developed by rotation is what keeps the current from becoming excessive. When the motor is first connected to the line it is not rotating and there is no counter emf. Some other way must be found to keep the current moderate. The simplest way is to put resistance in series with the armature²⁴ and then gradually reduce it ("cut it out") as the armature gains speed. The resistance is usually in

²² $I = \frac{E}{R}$. $E = 110 - 109 = 1$ volt. $R = 0.25$ ohm. $I = \frac{1}{0.25} = 4$ amperes.

²³ $E = 110 - 105 = 5$ volts. $R = 0.25$ ohm. $I = \frac{5}{0.25} = 20$ amperes.

²⁴ The field excitation is not cut down, but is of full strength from the start.

the form of wires or grids, mounted in a ventilated iron box, the whole known as a "starting rheostat" or "starting box." Various forms are used; Fig. 130 shows the connections in one type. The parts drawn in solid lines are supported on an in-

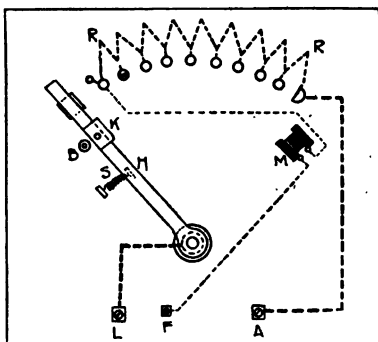

FIG. 130

Starting box for shunt motor

L-Connection to line F-Connection to shunt field
A-Connection To armature.

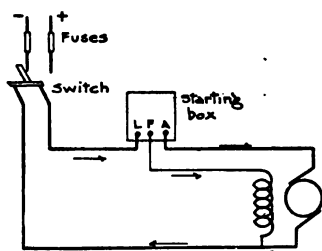
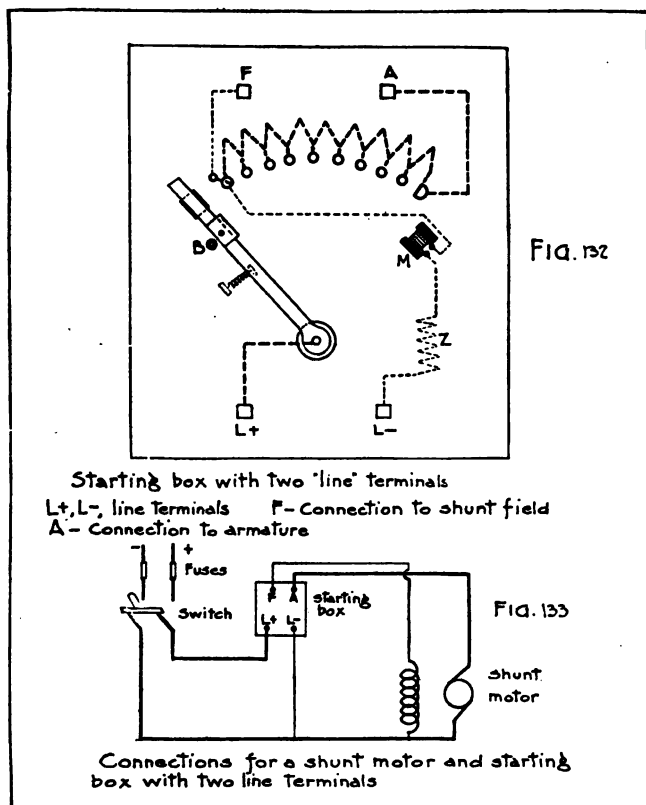

FIG. 131

Connections of shunt motor and starting box

insulating face plate, commonly slate. The internal connections are drawn in dashed lines. Fig. 131 shows how the starting box is connected between the fused main switch and the motor.

When the resistance is all cut out the iron strip *K* comes against the electromagnet *M*, and the handle is held in place. If the switch (Fig. 131) is opened, or the line becomes "dead" for any other reason, the magnet ceases to hold *K*, and a



spring *S* (Fig. 130) pulls the handle back against the buffer *B*, thus protecting the motor against injury in case the current is turned on again.

Some starting boxes have four terminals. The internal connections of one box of that kind are shown in Fig. 132, and the

connections to the motor in Fig. 133. The extra terminal is marked L —. It is needed because the electromagnet for the "no voltage release" is connected directly across the line, the high resistance Z being contained in the box to keep the current for it small.

Connections to a starting box must be made according to the way the terminals are marked on the box. They are almost always stamped with letters or with the words "line," "field," "armature," but will not always be found at the places shown in Figs. 130 and 132.

At the motor the circuits are often brought out on a terminal board after the fashion of Fig. 134. Care must be taken not to get them confused, for example, by connecting the field in place of the armature, or by making the sort of mistake shown in the right-hand diagram (marked "wrong") of Fig. 134, where the "A" terminal of the starting box is wrongly connected to the *junction* of armature and field, and the "—Line" is wrongly connected to the armature alone. Wrong connections are bound to cause trouble.

Starting and Stopping.—The proper operations for starting are:

1. See that handle of starting box is in the "off" position.
2. Close switch (see Figs. 131, 133).
3. Move starting handle to first contact. Armature should begin to turn. If it fails, open the switch at once, for something is wrong—perhaps a faulty connection, loose contact, blown fuse, excessive overload, wrong brush position, etc.
4. As armature gains speed, move handle over contacts, one step at a time. Move slowly if load is great, taking if necessary as much as 30 seconds. When the load is slight and the motor small, a few seconds may suffice.

The operation for stopping is: Open main switch. In a few seconds the handle should snap back sharply. If it falls, move it back by hand and look for dirty contacts. Sometimes wiping the contact studs and putting on just a trace of vaseline will cure the trouble.

Very small motors, rated at a fraction of a horsepower, are often connected directly to the line without a starting rheostat by simply closing a switch.

Reversing Direction.—In the diagram (Fig. 134) the mains are marked + and —. As a matter of fact, it makes no practical difference if the one marked + is really —, and vice versa. The motor runs in the same direction. It can be reversed by taking off the two connections at *F* (left-hand diagram, Fig. 134) and interchanging them. Care must be taken that the brushes rest on the commutator at the right place and point the right way for smooth running, as described in Section 106.

Speed Regulation and Control.—For reasons given under the heading “Limiting speed” a shunt motor generally runs a little more slowly when loaded (driving machinery) than when running free. The change of speed is called the “speed regulation.” For most motors the regulation is good, the change in

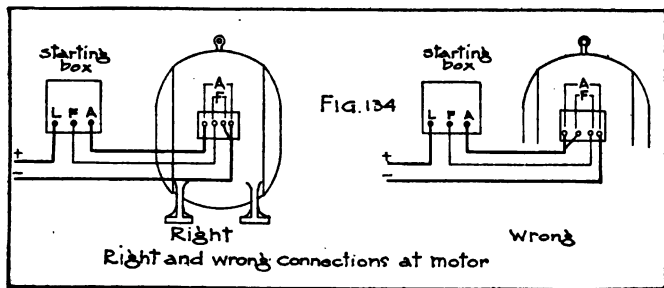

speed between no load and full load being only 5 per cent or less. Shunt motors are therefore often called “constant speed” motors.

This supposes that the voltage applied to the motor is constant. If it is too low, the speed falls off, as well as the power which the motor can develop. If it is too high, the motor will overspeed somewhat and is likely to overheat and to spark injuriously at the commutator. The speed can be changed, if necessary, by several methods. Only two will be described.

A resistance in series with the armature circuit only (not the joint line to armature and field) will reduce the speed. The conductor must be large enough to carry the armature current without overheating. The ordinary starting rheostat will not serve, as it is not made large enough for continuous duty. It would quickly overheat. Sometimes special rheostats are pro-

vided for starting, which are large enough to be left in circuit continuously. They are then usually marked "Regulating rheostat, for continuous duty."

The objection to this scheme is that it wastes power and that, if the load changes, the speed changes, too. It has the advantage of being simple.

A resistance in series with the shunt field winding increases the speed. This seems contradictory. The explanation is that when the field current is reduced the magnetism is weakened. The conductors have to move faster to generate about the same counter emf. as before, and since this counter emf. is always nearly as great as the applied voltage the speed has to increase.

The objection to this method is that the motor may overspeed and burst the armature by centrifugal force if too much resistance is used in the field circuit. There is also danger of damaging the commutator by sparking. It is not wise to raise the speed more than 10 or 15 per cent above that marked on the name plate unless the operator is very sure no harm will follow.

98. D. C. Series Motor.—The field coils of a motor may be made of thick wire and connected in series with the armature, so that the same current flows through both. It is then called a "series" motor. The difference in connections, compared with a shunt motor, is the same as for the corresponding kinds of generator. (See Fig. 117.) Series motors differ in their behavior from shunt motors in two important ways. They do not operate at constant speed, but run very much more slowly when heavily loaded; and at the lower speeds they develop a large turning force. They are therefore used on street cars, for cranking gasoline engines on automobiles, and similar duty where high turning effort is wanted for starting a load.

Suppose there is some current, say, 5 amperes, flowing in armature and field coils. Now imagine the load to increase until the current is 10 amperes. Two things happen. If the magnetism remained the same, the doubled armature current would cause double the pull. But the magnetism does not remain constant. When the current doubles, the field magnetism increases, because the 10 amperes flow in the field coils as well as in the armature. Thus the doubling of the armature current and the increased magnetization combined make the pull much more than double. Also the stronger field would make the counter emf.

automatically increase if the speed remained unchanged. But this is impossible because the counter emf. must always be a little less than the line voltage, else no current will flow to keep the motor going, so the speed must fall off.

The turning force mentioned above is called "torque." From the explanation just given, the torque of a series motor at starting is seen to be great, because at starting the speed is low and the armature current large. The less the load, the higher the speed. If the driving belt slips off, a series motor, unless it is quite small, can overspeed enough to wreck itself. Series motors are therefore direct connected or geared to the driven machinery. Shunt motors, on the contrary, will not overspeed and belts may safely be used.

Speed Control.—The only way of controlling the speed of a series motor that need be mentioned here is by using a rheostat. Except for small motors, one is needed anyway for starting. If large enough it can be left in circuit to keep down the speed. Of course, this is wasteful, because the heat produced in the rheostat uses electrical power.

99. Other D. C. Motors.—Connected like compound generators (Fig. 117), compound motors are used for special purposes, but the worker with radio equipment is not likely to run across them, and for that reason they are not treated here.*

100. Combination A. C. and D. C. Motors.—Reversing the current in the line to which a series motor is connected has no effect on the direction in which the armature turns. If the current is reversed in the field coils alone the magnetism is reversed and the armature turns the opposite way. Reversing the current in the armature, too, makes a second reversal of force; that is, the armature turns as it did at the beginning. This is still true when the reversals are so rapid that the current is truly alternating, so the same motor can be used for a.c. and d.c. But in that case some special construction is necessary; for example, the magnets are built up of laminations instead of being in a solid piece.

101. Alternating Current Motors.—*Induction Motors.*—When the terminals of any coil are connected to a circuit, the cur-

* Compound motors are explained in Rowland, p. 126; Franklin and Esty, "Dynamotors and Motors," p. 144; Timble, "Elements of Electricity," p. 221.

rent sets up a magnetic field in and around the coil. When a number of coils are arranged in the form of a stationary two-phase or three-phase armature²⁶ and connected to a corresponding two-phase or three-phase power circuit, there comes the remarkable result that the alternating currents flowing in the coils produce inside of the armature a magnetic field which rapidly and continuously revolves. The iron core and the copper coils are both stationary; only the magnetism changes. If the changes of current are made slowly a compass needle placed in the open space within the armature will spin just as if it were directed by an imaginary magnet with its poles sliding along the face of the armature.

Next, let an iron core with suitable coils on it be placed inside this armature, on a shaft, so that it can turn. The revolving magnetic field cuts across the conductors of this movable "rotor"; that sets up emfs.; currents flow, and now we have conductors with currents in them in a magnetic field. Consequently the rotor begins to turn. It speeds up until it turns nearly as fast as the moving magnetic field. How fast that is depends on the construction of the stationary armature and the frequency (cycles per second) of the alternating current supplied.

The machine just described is an "induction" motor.²⁷ Its parts are called the stator (stationary part) and rotor (part that revolves) just as in an alternator. Nothing has been said about any connection between the rotor and an external electric circuit. In the simplest form of induction motor there is no such connection. The rotor is dragged around magnetically at a practically constant speed. A pulley on the rotor shaft can be used with a belt to deliver power to some other machine.

An induction motor can be considered to be a particular kind of a. c. transformer in which the secondary winding and the secondary core are allowed to revolve with respect to the primary, and the secondary winding is short circuited. In the transformer the position of the secondary is fixed, and the emf. induced in the secondary winding causes a current to flow

²⁶ See also Sec. 75.

²⁷ For further explanation of action see Timble and Higbie, "A. C. Machinery, Second Course," pp. 429-449; Franklin and Esty, "Dynamos and Motors," pp. 340-362; Rowland, pp. 252-270.

which delivers electric power in the secondary circuit. In the induction motor the emf. induced in the secondary causes a current to flow in the short-circuited secondary winding, and this secondary current causes the secondary to revolve and deliver mechanical power.

In some forms of induction motor there are connections between the rotor, which in that case has slip-rings, and an external circuit. But the external circuit is not a power circuit; it merely consists of resistances for controlling the motor speed.

The terms "squirrel cage" and "wound" are often used to describe rotors; the first means the simple kind with conductors of plain bars of metal and no slip-rings or other moving contacts; the second means the kind having coils like an armature, and, commonly, slip-rings.

If one of the connections to a three-phase induction motor is opened, leaving only two attached, the rotor continues to turn. Two wires can supply only a simple a. c. (single phase), so it is evident that an induction motor can be used on a single phase circuit. But it will not start on a single phase without a special starter.

Like d. c. motors, those for a. c. have to be operated at about the voltage for which they were built. In addition, they have to be connected to a line of the right frequency. Then they run at certain definite speeds, which are nearly as high at full load as when running free. On 60-cycle circuits the common speeds for small motors are a little under 1800, 1200, and 900 r. p. m.

Starting.—Small induction motors are started by simply connecting them to the right kind of power circuit by a switch, double-pole (two blades, for two wires) for single phase, three-pole for three-phase, and four-pole for two-phase motors. With polyphase (two or three phase) motors, this produces the revolving magnetic field as previously explained. With single phase the action is different. It was said, earlier in this section, that an induction motor will not start on one phase, but will continue if started somehow. One way might be to give it a start by hand. Generally, that is not a practical method. A second way is to use a "phase splitter." That merely means that the current goes through the stator by two paths in parallel, one having more inductance or capacity than the other. Inductance in any branch of a circuit causes a phase-lag in that

branch. The armature must have two sets of coils, and if the currents in them differ as to phase, the motor starts as a sort of two-phase machine. After it gets up to speed, one winding (the "starting" winding) is disconnected. That may be done by hand, a special two-way switch being provided with a starting and a running position or there may be an automatic centrifugal cut-out in the motor.²⁸

A third way is by "repulsion motor" action. Then the rotor has a commutator and brushes, like those for d. c. The stator is connected to the supply line, the rotor is not. The brushes are connected together by a short-circuiting conductor. When currents flow in the stator, other currents are induced in the rotor²⁹ and it begins to turn. At the proper speed, a centrifugal device short-circuits the commutator and so converts the machine into a simple induction motor. At the same time, the brushes are lifted automatically, to reduce friction.

Larger three-phase motors are started by applying a fraction of full voltage, obtained by a combined transformer and double-throw switch known as a "compensator."³⁰

Synchronous Motors.—In Sections 73 and 74 there have been described briefly several forms of alternators, and their use as generators of alternating current. If two alternators of identical construction are driven at the same speed, they may be connected in parallel to supply the same distributing line. If now the supply of mechanical power to one alternator is cut off, as by slipping off the belt, that alternator will usually continue to operate as a motor, taking power from the other alternator. An alternator operating as a motor in this way is called a "synchronous motor," and may be either single phase or poly-phase. It is not at all necessary that a synchronous motor be of the same size as the generator supplying it; a number of

²⁸ Split phase starting is described in Timble and Higbie, "A. C. Electricity, Second Course," pp. 510-512.

²⁹ See Timble and Higbie, "A. C. Electricity, Second Course," p. 514; Rowland, p. 270; Franklin and Esty, pp. 383, 386; Standard Handbook, p. 542.

³⁰ For details and other methods of starting, see Timble and Higbie, "A. C. Electricity," p. 454; Franklin and Esty, "Dynamoes and Motors," p. 360; "Standard Handbook for Electrical Engineers," pp. 520, 1292, 1293; A. S. McAllister, "Alternating Current Motors"; C. E. Magnusson, "Alternating Currents."

small synchronous motors can be driven by one large generator. Synchronous motors are much less used in practice than induction motors. Synchronous motors of large size have particular applications. The single-phase synchronous motor will not start itself, except by the use of special starting devices, some of which are similar to those described for starting the single-phase induction motor. The synchronous motor must operate at exactly the frequency of its supply, and if it falls out of step for any reason it will usually stop. The synchronous motor must operate at the same speed at any load, while the speed of the induction motor varies with the load. By adding a commutator to the synchronous motor it becomes a "synchronous converter" or "rotary converter." (See Sec. 103.) The construction of one kind of synchronous motor is shown in Fig. 97, page 157. For further information see A. S. McAllister, *Alternating Current Motors*.

F. Motor Generators and Dynamotors.

102. Motor Generators.—When electric current is to be had, but not in the form needed, the change is made by transformers,²¹ rectifiers, motor generators or dynamotors, according to circumstances. The first named change a. c. at one voltage to a. c. at another voltage at the same frequency. The second change a. c. to pulsating d. c. The last two are used for changing a. c. at one frequency to a. c. at another frequency or to steady d. c., or the reverse; also for changing d. c. from one voltage to another.

The most easily understood way to make the change is by the use of a suitable combination of motor and generator, built for the same speed and mounted on a common base, the shafts being coupled together. Such a combination is a "motor generator."

Motors and generators have been described. The combination brings no new ideas. Each part can be thought of by itself, without regard to the other. Examples of such machines have been given.²² In radio practice they are used particularly for battery charging and for supplying spark and arc circuits.

Battery Charging.—Motor generators for battery charging are used where the supply is a.c., or d.c. at the wrong voltage. In the latter case if the d.c. voltage is too high, a rheostat may be

²¹ Described in Sec. 58.

²² Sec. 94, Figs. 121, 122, 124.

used, but it wastes power. When several low-voltage batteries have to be charged, they may be connected in series and the power wasted in resistance thereby reduced.

The generator of a battery charging unit is usually shunt-wound. The voltage of a storage battery rises as it gets charged. Also, at the beginning it is allowable to use a larger current than toward the end of the charge. The voltage of a shunt generator is lower when it is delivering a large current than when the current is small.²³ Therefore such a generator, connected to a discharged battery and given the proper setting, produces a large current which gradually decreases as the battery voltage rises. It is also possible to use a compound generator, so designed that the voltage is substantially constant, whatever the current within the limits of the machine. In that case the initial rate of charging the battery is higher than when a shunt generator is used, but falls off in the same way. A high rate of charging at the beginning cuts down the time required for the whole process, and is therefore desirable, provided it does not injure the battery. Modern portable batteries will stand charging in this way and compound generators may consequently be used. The proper treatment for a given battery must be learned from instructions pertaining to that particular form.

Motor generators are used also for connection to ordinary lighting circuits (about 110 volts) to get 500 or 600 volts d.c. for arc transmitters,²⁴ or for connection to such circuits or to low voltage storage batteries to get a.c. at 500 to 900 cycles for use with transformers in audio-frequency spark transmitters.²⁵ Motor generators may also be used for supplying 300 or more volts to the plates of electron tubes used for generating undamped alternating currents of radio frequency. (See pages 491, 498.) Such alternators and motor generators have been described in Section 94.

103. Rotary Converters.—If connections are made to a pair of collector rings from opposite sides of a two-pole d.c. armature, it will generate alternating current. At the same time, direct current can be taken from the commutator. In that case the ma-

²³ Shown in Fig. 118. ²⁴ See Sec. 174. ²⁵ See Sec. 154, page 354.

chine is a "double current generator." If not driven by an engine, but connected to a d.c. circuit, it operates as a shunt motor and can be used to generate a.c. Operated on a.c. as a motor, it delivers d.c. When used for such conversion it is called a rotary converter. When an a.c. generator is used as a synchronous motor (not an induction motor) it requires d.c. for field excitation and operates at the exact speed (called "synchronous" speed), corresponding to the frequency of the supply. The d.c. for the rotary converter field comes from the commutator. On the other hand, when such a converter is used to generate a.c., the frequency depends on the speed of rotation of the armature, which can be controlled as previously described for the shunt motor. When a rotary converter is used in this way for converting direct current into alternating current, it is said to be operated as an "inverted rotary."

The rotary converter has the advantage of accomplishing in a single machine what the motor-generator does in two. Its disadvantage is that the voltage at the generator end depends entirely on the voltage supplied to it as a motor, the effective value of the a.c. voltage in the case of a single-phase converter being about 71 per cent of the d.c. voltage, slightly more or less, depending on the direction of the conversion. Thus, if operated on a 10-volt storage battery, it would give about 7 volts a.c. In radio communication it is desirable to have a machine which will deliver a.c. of a frequency of 500 cycles when supplied with d.c. from a storage battery. Small rotary converters can not be designed to supply a.c. of a frequency anywhere near as high as 500 cycles. Either the speed or the number of commutator segments would have to be increased beyond reason.

Instead of single phase, rotary converters can be built for two-phase or three-phase currents, the former by four connections equally spaced on the armature and four rings, the latter by three connections and three collector rings. The statements made for bipolar machines are equally true for multipolar rotary converters, if it is understood that each ring has as many connections to the armature as there are pairs of poles.

The rotary converter, or "synchronous converter," is really a synchronous motor to which a commutator has been added, but the design of rotary converters requires a number of modifications from synchronous motor design. In external appear-

ance a polyphase rotary converter resembles a direct-current generator with a conspicuously large commutator and an auxiliary set of collector rings.

104. **Dynamotors.**—Rotary converters cannot be used for changing direct current at one voltage to d.c. at another voltage. The most compact machine for that purpose is the “dyna-

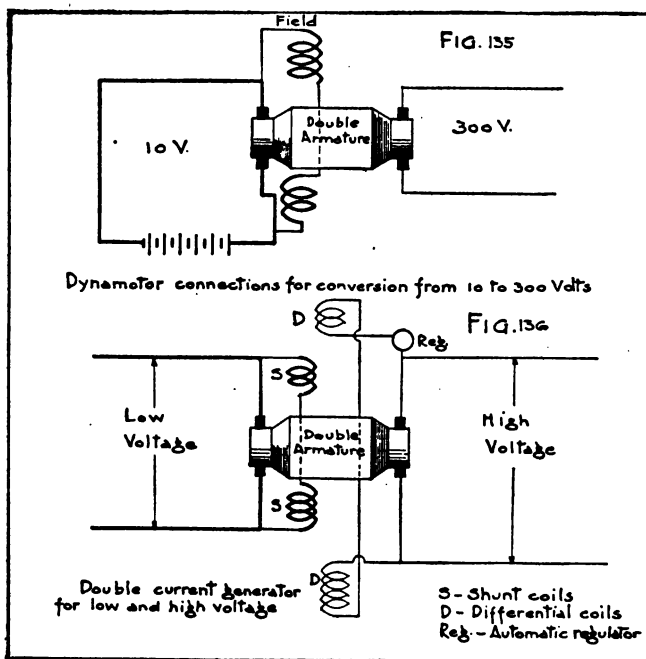

motor.” An application which will occur to the radio student is the securing from batteries giving only 10 or 12 volts of the 300 or more volts required for supplying the plate potential of electron tubes used as generators of radio-frequency alternating current. (See Fig. 135.) In the dynamotor two separate armature windings are placed on a common core. One acts as a motor, the other as a generator. There is but one frame and

one set of field magnets. The two windings are connected to commutators at opposite ends of the shaft. The ratio of voltages is fixed when the machine is built, so the output voltage depends on the voltage applied. The field coils receive current from the same source as the motor armature.

105. Double-Current Generators.—A dynamotor can be driven by mechanical power as a generator, and can then deliver d. c. at two different voltages. Such machines have been designed for fan drive on airplanes, the low and high voltages being used for the filament and plate currents, respectively, of electron tube transmitters.

To get constant voltages, in spite of the varying speed at which the armature is driven, the field flux must be weakened as the speed rises. Current taken from one commutator is sent around the field coils, supplying the main magnetization. A weaker current from the other commutator is sent around the opposite way, giving a differential effect. (Fig. 136.) If the speed rises, and consequently the voltage, the current in the second winding is made to increase considerably by a sensitive automatic regulator. The flux is therefore reduced, counteracting the effect of the rise in speed.

106. Common Troubles.—Electrical machinery is subject to the same troubles as other machinery, such as rough, gritty, dry or tight bearings, bad alignment, sprung shaft, etc., which show themselves by heating, taking excessive power, and vibration. The bearings must be clean and smooth. Care must be taken never to spring or jam the shaft. There must always be enough oil of good quality in the oil wells to keep the bearings thoroughly lubricated. Most generators and motors are oiled by means of brass rings that ride on the shaft and dip into the oil and carry it up as they turn. Sometimes these are injured in taking the machine apart; then they do not turn properly; the bearing runs dry and heats.

Some machines have ball bearings. They should run very easily, but are subject to the same troubles as a bicycle bearing, such as broken balls, grit, adjustment too tight. In general if a bearing gets too hot to be borne with the hand, it needs attention; the trouble is likely to grow worse, until finally the shaft binds firmly and cannot be turned. The job

of getting it free again may then be a very tedious and troublesome one.

Another point of friction is at the brushes. If they are pressed in too firmly, they rub harder than necessary. They should be fitted smoothly so as to give the full area of electrical contact, then excessive pressure will not be needed. They should be only tight enough to make good contact and prevent sparking or flashing. When carbon brushes are working properly, the metal surface on which they rub becomes finely polished, and wears down very slowly. This is particularly noticeable in the case of copper commutators on direct current machines.

Besides those of a mechanical nature there may be electrical troubles, some requiring expert attention, others easily found and cured. The most common electrical troubles are caused by loose, wrong, or missing connections, and dirt.

Connections (usually accidental) that allow current to pass by a piece of apparatus, instead of flowing through it, are called "short circuits." They are a common source of trouble.

A systematic way of hunting troubles is as follows:

1. Make or find a circuit diagram, unless you are thoroughly familiar with the connections and are positive they are right. In drawing diagrams follow each branch of the circuit from the source (+terminal of battery or generator armature) completely around (through the —terminal) to the place of beginning. Remember that no current will flow in a circuit or in any part of a circuit unless there is a difference of potential in it.

2. Trace the wiring according to the diagram.

3. While tracing, see that—

(a) Fuses are good, if any are in circuit.

(b) Connections are clean and good.

(c) Contact is not prevented by insulating caps of binding posts or insulation of wire.

(d) Wires do not touch, making short circuits.

(e) There are no extra wires or connections.

(f) There are no breaks in wire inside of the insulation. This occasionally happens with old lamp cord. The broken place is very limber, and can be pulled in two more readily than a sound place.

4. Look for defects in the apparatus itself.

In a generator, besides loose connections, electrical troubles easily remedied are, for d.c. :

5. Failure to generate emf., caused by—

(a) Brushes not in the right place. On nearly all d.c. generators of reasonably modern construction, the proper position for the brushes on the commutator is nearly opposite the middle of the field poles, or slightly forward (in the direction of rotation) of that point. The exact location, found by trial, is that which gives sparkless commutation. Brushes are set right at the factory, and should be left as they are, unless there is good reason to believe that they have since been shifted.

(b) Brushes not making good contact because of bad fit or too little pressure. Test by lifting them slightly, one by one, to detect loose springs; also try pressing brushes to commutator with dry stick. Remedy by working fine sandpaper back and forth, sharp side out, between commutator and brush (holding it in such a way that the toe of the brush is not ground off) or by tightening brush springs, as needed.

Brushes are designed, either to press against the commutator squarely, pointing toward the center of the shaft, or, more commonly, to trail somewhat as an ordinary paint brush might trail if held against the commutator. However, there is also in very satisfactory use a form of holder by which the brushes are held pointing against the direction of rotation. Instead of sliding up or down in a box they are pressed against a smooth face of brass by springs.

(c) Field connections reversed.

6. Sparking, when caused by

(a) Roughened commutator; cured by holding *fine* sandpaper (not emery) against it while running.

(b) Brushes shifted; for remedy see 5, above. It is very important that all brushes be at the proper points. This means, for example, that if the brushes are supposed to touch at four points, spaced a quarter way around the commutator, they shall actually be exactly a quarter of a circumference apart, as tested by fine marks on a strip of paper held against the commutator.

7. Heating of commutator due to brush friction. Reduce tension of springs.

In a. c. generators look for—

8. Loose connections and bad contacts at brushes. Position of brushes on rings is immaterial, as there is no commutation.

In d. c. shunt motors, motor-generators, or dynamotors, the simple troubles are:

9. Failure to start, or starting suddenly with speed quickly becoming excessive, due to wrong connections. (See Sec. 97.)

10. Sparking, caused by excessive load or wrong brush position. (See 5 and 6 above.) The proper position for motor brushes is slightly backward (against the direction of rotation) of the center of the field poles.

CHAPTER 3.

RADIO CIRCUITS.

A. Simple Radio Circuits.

107. **The Simplicity of Radio Theory.**—The principles of alternating currents developed in Chapter 1 are applicable to radio circuits. Radio currents are merely very high frequency alternating currents. The fundamental ideas of sine waves (Sec. 50) apply to what are known as continuous or “undamped waves.” “Damped waves” also behave in many ways like sine waves; for some purposes slight modifications of the sine wave theory are needed. These are treated in Part B below.

The frequencies of alternation of radio currents are very high. Ordinary alternating current power circuits use frequencies from 25 to 60 cycles per second. The lowest radio frequencies, however, lie above some 10,000 cycles per second, and the upper limit may be put at perhaps 300,000,000 cycles per second. Such an enormous difference in frequency should naturally give rise to some differences in the behavior of radio circuits as distinguished from low-frequency alternating current circuits.

In low-frequency a.c. circuits the principal opposition to the flow of currents through the wires connecting the various machines and other parts of the circuit is the resistance of the wires. It is only in unusual cases that the inductance and capacity of the connecting wires requires consideration in low-frequency a. c. circuits, although the inductance of the windings of generators, motors, and transformers is important. The inductance and capacity of every part of a radio circuit are usually of much more importance than the resistance.

The reactance of such small inductances as are provided by a few turns of wire is of importance, and condensers whose small capacity would very effectually prevent the flow of ordinary alternating currents readily allow the passage of radio currents. The mutual inductance effect of one circuit on another is much greater, when radio frequencies are used, than is the

case with ordinary alternating current circuits. The enormous frequencies used in radio work give rise also to much larger skin effect (see Sec. 117, p. 263), eddy currents, and dielectric losses than would be the case if the same circuit were worked at low frequency.

Furthermore, measuring instruments commonly used for alternating current work are, for the most part, unsuitable for use in radio circuits, or require modified methods of connection. Instruments whose indications depend upon the heating effect (Section 59) are, in general, suitable for radio work. Direct current instruments may also be used, but in connection with rectifying devices. The telephone receiver, so useful in low frequency work, requires a rectifier also. At low frequencies

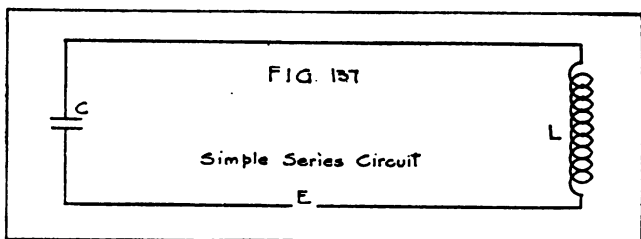

the diaphragm of the receiver vibrates with the current, giving an audible singing note of the same frequency as the alternating current. Radio currents execute their changes, however, altogether too quickly to be followed by the telephone directly, and even were it possible for the diaphragm to vibrate so rapidly, the sound produced would be of too high pitch to be heard by the ear. It is found to be necessary, therefore, to break up the radio currents into groups of rectified waves. Each group gives a single impulse to the diaphragm, and if the impulses follow regularly with sufficient rapidity a musical note is produced.

108. **The Simple Series Circuit.**—The simplest form of radio circuit is one having resistance, inductance, and capacity in series, as in Fig. 137. An alternating emf. is supposed to be applied at E .

In Chapter 1, Section 57, page 127, it has been shown that the value of the current produced in a circuit, to which an alternating emf. is applied, may be calculated by the equation,

$$\text{Current} = \frac{\text{emf.}}{\text{impedance.}}$$

If the effective value of the emf. is used here, the equation gives the effective value of the current. (Sec. 51, p. 118.)

The impedance Z depends not only on the resistance R , but on the reactance X of the circuit as well. (Secs. 55, 57.) For a sine wave of applied emf.

$$Z^2 = R^2 + X^2 \quad (69)$$

That is, the square of the impedance is found by adding the squares of the resistance and the reactance. The impedance can therefore never be less than the resistance, and may be very much greater. If the resistance in the circuit is very small in comparison with the reactance, the impedance is practically equal to the reactance. The impedance is measured in ohms.

As has been pointed out (Sec. 49), the reactance is the opposition offered to the current by an inductance or a capacity. The reactance, in ohms, of an inductance coil is equal to 2π times the frequency, times the inductance in henries. For a capacity, the

reactance, in ohms, is equal to $\frac{1}{2\pi fC}$ (Sec. 56), in which f is the

frequency and C is the capacity in farads. In their reactive effects an inductance and a capacity tend to offset one another, so that the total reactance of an inductive coil and a condenser in series is found by taking the difference of their individual reactances.

It is general practice to use the symbol ω to represent 2π times the frequency ($2\pi f$), since the quantity $2\pi f$ very frequently occurs in problems involving radio circuits. (See Circular 74, p. 22.) Using this abbreviation, the reactance of an inductance may be written ωL , and the reactance of a capacity may be written $\frac{1}{\omega C}$.

Example.—Let us calculate the reactance of the combination of a coil of 500 microhenries inductance in series with a condenser of 0.005 microfarad capacity at several different frequencies.

Frequency cycles per second.	Reactance of coil (ohms).	Reactance of condenser (ohms).	Total react- ance (ohms).
60	0.188	-530,000	-530,000
1,000	3.142	-31,840	-31,837
100,000	314.2	-318.4	-4.2
100,700	316.23	-316.23	0
1,000,000	3,142	-31.84	3,110

The table shows at a glance that the reactance of the coil is small at low frequencies, increases as the frequency rises, and becomes very considerable at the higher frequencies, such as occur in radio work.

The behavior of the condenser is just the reverse. At the lowest frequency it offers a very large reactance, but at radio frequencies the impedance is vastly smaller. For very high frequencies the reactance would be negligible.

In most radio circuits the resistance of the circuit can be kept as small as a few ohms. It is therefore obvious that only in the case of the 100,000 cycles, in the table, would it be necessary to take account of the resistance in calculating the impedance.

For example, if $R=5$ ohms, the impedance for the frequencies in the table above will have the values 530,000, 31,837, 6.5, 5 and 3110, respectively. In all except the third and fourth cases, the difference between the reactance and the impedance is less than one part in a million of the total.

It is thus apparent that in many cases the impedance of a circuit depends almost entirely on the reactance of the circuit. Only in those cases where the reactance is small is it necessary to take the resistance into account.

109. Series Resonance.—It would seem at first sight, then, that radio circuits would offer for the most part a high impedance and that therefore very little current could flow, except with very large emf. This is in general true of any radio circuit if the frequency be taken at random. However, by properly adjusting the value of the frequency, the reactance of the cir-

circuit may be made zero. This is at once evident, when we remember that the inductive reactance increases with the frequency, while the capacitive reactance diminishes. At some definite frequency, then, the inductive reactance of the coil must have the same value as the capacitive reactance of the condenser, and since they act against each other, the total reactance will be zero.

This may be shown graphically. In Fig. 138 are plotted the curves *A* and *B* of the reactances of the coil and condenser, respectively, of the previous example. Frequencies are measured along the horizontal axis and reactances along the vertical axis. The reactances of curve *B* are taken as negative to distinguish between the opposing effects of the inductive and capacitive reactances. Curve *C* is obtained by taking the algebraic sum of the reactances of curves *A* and *B*. It is the curve of resultant reactance in the circuit. For the particular values of *C* and *L* chosen in this example, the circuit acts like an inductive reactance at all frequencies greater than a value of slightly above 100,000 cycles, while below that point it has the character of a capacitive reactance. Furthermore for only a narrow range of frequencies, 99,000 to 103,000, perhaps, the reactance of the circuit is less than 10 ohms. For most frequencies the reactance is much greater than this.

The frequency which makes the capacitive and inductive reactances equal is called the "resonance frequency" of the circuit, and the circuit is said to be in "resonance," or to be "tuned" to the frequency in question. It is important to be able to calculate the frequency for resonance. To do so, the condition must be fulfilled, that

$$2\pi fL = \frac{1}{2\pi fC} \quad (70)$$

which shows that the frequency at resonance must be

$$f = \frac{1}{2\pi\sqrt{LC}} \quad (71)$$

Applying this relation to the example under discussion, and substituting therein $L=0.0005$ henry, $C=\frac{5}{10^9}$ farad, the resonance frequency is found to be about 100,700 cycles per second. The reactances of both the coil and the condenser at this fre-

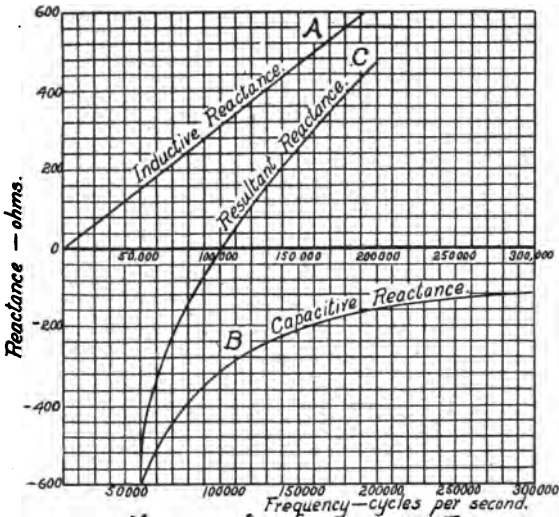

Fig. 138. Variation of reactance with Frequency.

$L = 500$ microhenries
 $C = 0.005$ microfarads

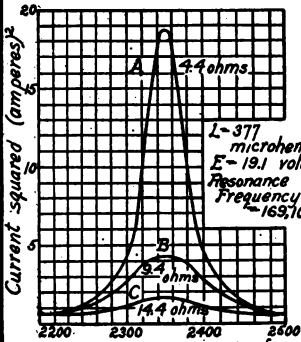

Fig. 139. Resonance Curves for Series Resistances.

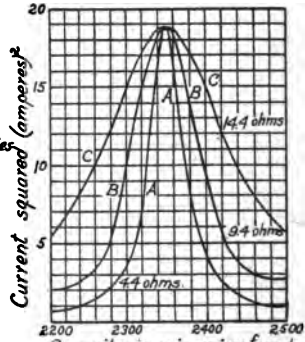

Fig. 140. Effect of Resistance on the shape of the Resonance Curve

quency are the same and have the value 316.2 ohms. This value may, of course, be calculated by using for f the value of the resonance frequency in either of the expressions $2\pi fL$ or $\frac{1}{2\pi fC}$. It is of interest to note that each of these expressions for reactance reduces simply to $\sqrt{\frac{L}{C}}$, when the frequency has the resonance value.

There exists, then, for any series circuit containing inductance and capacity a definite value of the frequency, for which the total reactance in the circuit is zero, and the impedance is simply equal to the resistance of the circuit. This frequency is called the resonance frequency, and the circuit is said to be in a condition of resonance. The impedance has its smallest value, and the current which flows in the circuit when the applied emf. has any value whatever has the largest value possible with that value of frequency.

These facts may be readily verified experimentally by inserting in a simple radio circuit a suitable ammeter for measuring the current. If now the frequency of the applied emf. is gradually raised, the current will at first be small and will increase very slowly as the frequency is increased. In the immediate neighborhood of the resonance frequency the current will suddenly begin to increase rapidly for small changes of frequency, and after passing through a maximum will rapidly decrease again as the frequency is raised to still higher values. The results of such an experiment may be shown by a curve in which frequencies are measured in the horizontal direction, while the values of the current corresponding are plotted vertically. Since most instruments suitable for measuring radio currents give deflections proportional to the square of the current, it is customary to plot the squares of the current, or the deflections of the instrument, rather than the current itself. Such "resonance curves" are plotted in Fig. 139, and they show plainly the "resonance peak" of another circuit having different constants. (See p. 241.)

On account of its great importance in radio work the phenomenon of resonance requires further study. To fix our ideas, let us suppose that a circuit whose inductance and capacity have the values already chosen in the previous example (500

microhenries, 0.005 microfarad) has a resistance of 5 ohms and that an emf. of 10 volts is applied in the circuit. The maximum possible value of the current is found by dividing the applied voltage by the resistance, which gives 2 amperes. This current will flow when the frequency has the critical value of 100,700 cycles per second. To study the distribution of emf. over the different parts of the circuit we have to remember (Sec. 55) that the emf. between any two points of the circuit has to have a value equal to the product of the current by the impedance between the two points. Accordingly the emf. between the ends of the resistance is $2 \times 5 = 10$ volts, that on the coil is $2 \times 316.23 = 632.46$ volts, and the same emf. is found between the terminals of the condenser also.

The existence of such a large voltage on both the coil and the condenser explains how it is possible to obtain such a relatively large current through the large reactances of the coil and condenser. The small applied voltage is employed only in keeping the current flowing against the resistance of the circuit, not for driving the current through the coil or condenser. To explain the presence of the large voltages on coil and condenser, it must be remembered, as was shown in Section 57, that when a current is flowing through an inductance and capacity in series the emf. on the inductance opposes that on the capacity at every moment. The sum of the voltages on the two is therefore found by subtracting their individual values. Since at the resonance frequency the emf. on the inductance has the same value as the emf. on the capacity, the emf. between the terminals of the two in series is therefore zero.

Energy is supplied to the circuit by the source at a rate which may be determined (when the resonance condition has been established) by simply multiplying the emf. by the current. (Sec. 55, p. 123.) That is, in the present instance the power is $10 \times 2 = 20$ watts. The power dissipated in heat in the resistance may be calculated by taking the product of the resistance by the square of the current. (Sec. 51.) In this case it is $5 \times 2^2 = 20$ watts. The source, therefore, supplies energy to the circuit at just the right rate to make good the energy dissipated in heat in the resistance. After the current has reached the final effective value (2 amperes in this case) no further energy is supplied to the coil or condenser by the source, but their

energy is simply transferred back and forth from one to the other without loss or gain in the total amount, nor is any outside agency necessary to maintain this condition.

In the above discussion of a simple series circuit, consisting of a resistance, an inductance, and a capacity in series, it has been assumed that the inductance coil was a pure inductance and that the capacity was a pure capacity—that is, that neither had any resistance and that the entire resistance of the circuit was concentrated in the resistance unit. In actual practice these ideal conditions can not be absolutely realized, although they may be very closely approximated. The inductance coil necessarily has a certain amount of resistance in which energy is dissipated as heat, and there may be other sources of energy loss in the inductance coil. The insulating material between the plates of the condenser constituting the capacity is not an absolutely perfect nonconductor, but allows a certain very small leakage current to flow, resulting in a small loss of energy as heat. There are also other sources of energy loss in condensers.^a The effect of these energy losses in the condenser is equivalent to introducing additional resistance into the circuit. With suitable design, the energy losses in both inductance coils and in condensers may be made very small.

Mechanical Example of Resonance.—Many mechanical examples of resonance might be cited. It is a well-known fact that the order to “break step” is often given to a company of soldiers about to pass over a bridge. Neglect of this precaution has sometimes resulted in such violent vibrations of the bridge as to endanger it. This is especially the case with certain short suspension bridges.

When a shock is given to a bridge it vibrates, and the frequency of the vibrations—that is, the number of vibrations per second—is always the same for the same bridge, whatever the source of the shock. The frequency of vibration is analogous to the resonance frequency of the circuit. For if an impulse be applied to the bridge at regular intervals, tuned so that the number of impulses per second is exactly equal to the number of

^a A discussion of energy losses in condensers may be found in Bureau of Standards Circular No. 74 and in a paper by J. H. Dellinger, Proceedings Institute Radio Engineers, vol. 7, p. 27, February, 1919.

vibrations natural to the bridge in the same time, violent vibrations may be set up, although the individual impulses may be small. In fact, when the bridge is thus vibrating the impulses need to have only just force enough to overcome the frictional forces and thus keep the vibrations from dying away. The much greater forces involved in the vibrations themselves correspond to the large voltages acting on the coil and condenser. The voltage on the condenser is of the same nature as the large forces which exist in the beams of the bridge when they are stretched, while the voltage on the coil corresponds to the very considerable momentum of the moving bridge. The small force of the impulses given the bridge corresponds to the small applied emf. in the electrical case.

If the vibrations of the bridge ever become so violent as to rupture it, it means that the beams have been stretched beyond their breaking point. Similarly the dielectric of the condenser may be broken by the emf. existing between its terminals in cases where the resonance current is too large.

110. Tuning the Circuit to Resonance.—The practical importance of resonance lies in the fact that it enables the impedance of a circuit to be made equal to the resistance alone. It must be remembered that the reactance of the small inductances in the circuit, which are unavoidable, becomes important at radio frequencies and may often be much greater than the resistance.

This fact, taken in connection with the smallness of the emf. of incoming signals, would make it impossible to obtain any but minute currents in the receiving apparatus with inductance alone in the circuit. From this standpoint, the sole function of the tuning of the circuit to resonance is to offset the inductive reactance by an equal capacitive reactance, so that the impedance may be made as small as the resistance.

The circuit may be tuned to resonance in three ways—

- (a) By adjusting the frequency of the applied emf.
- (b) By varying the capacity in the circuit.
- (c) By varying the inductance in the circuit.

Of these, the first case has already been treated, the other two find application in receiving circuits where the frequency of the incoming waves is beyond the control of the operator, in the use of coupled circuits and in the adjustment of the frequency of the waves emitted in certain methods of sending.

The possibility of tuning a circuit is of course not confined to radio circuits, but is present also with ordinary alternating current circuits, and is becoming common in telephone work. However, at low frequencies the values of the inductance and capacity involved are relatively great, so as to make it inconvenient to vary their values in steps sufficiently small. Furthermore, in low-frequency work the reactances of the coils likely to occur in the circuit are small, and the large quantities of power involved render the use of condensers relatively uncommon. The inductances and capacities used in radio work, on the other hand, are relatively small, and the construction of coils of continuously variable inductance ("variometers" or variable inductors) and of apparatus of variable capacity (variable condensers) offers no particular difficulties.

From formula (71) it appears that it is the product of the inductance and capacity, rather than their actual values, which determine the resonance frequency. To tune a circuit to a given frequency, the inductance may be large or small, provided only that the capacity may be so adjusted that the product of inductance and capacity shall have the value corresponding to the frequency assumed. (A table showing these variations with the product of inductance and capacity is given in Appendix 5, p. 557.)

111. Resonance Curves.—A resonance curve is a curve which shows the changes of current in a circuit, when changes are made which cause the resonance condition to be somewhat departed from. For example, the current (or square of the current) may be plotted for different values of the frequency somewhat above or below the resonance frequency. Or, the curve may show the change in current, when the capacity (or inductance) is somewhat raised and lowered with respect to the value which holds for the condition of resonance. Such curves are often determined experimentally, in whole or in part, on account of their value in calculating the damping of the circuit. (Damping is treated in Sec. 116 below.) Such, for example, are the curves of Fig. 139, in which are plotted the values of the current squared, to an arbitrary scale, for different values of the capacity of the variable condenser. The inductance of the circuit was fixed at the value 377 microhenries. Three different curves were determined with the re-

sistance in the circuit fixed at the values 4.4, 9.4, and 14.4 ohms, respectively.

Sharpness of Resonance.—It was, of course, to be expected that the value of the current at resonance (height of the peak), should be greater, the smaller the resistance in the circuit, but attention needs to be called particularly to the sharpness of the curve with the smallest resistance and to the flatness of the curve with greatest resistance. This is the characteristic of resonance curves in general, and is a necessary consequence of the equations for the impedance. It may be shown still more clearly, if the scales to which the three curves are plotted are so altered that the peaks of the three curves have the same height. This has been done in Fig. 140, page 236.

The same results may be seen by calculating the square of the impedance with different settings of the condenser and with different resistances in the circuit. The resonance frequency in this case was 169,100 cycles per second, which shows that with the inductance of 377 microhenries the setting of the condenser at resonance is almost exactly 2,350 micromicrofarads. The reactance of condenser and coil at this frequency is 400.56 ohms in each case.

The following table shows the impedances for three different settings of the condenser when the resistance of the circuit has the three values corresponding to those of the curves. The squares of the currents are, of course, less in proportion as the squares of the impedances are greater.

Setting of condenser (micromicrofarads).	Impedance squared.		
	For $R=4.4$	For $R=9.4$	For $R=14.4$
2300	94.1	163.1	282
2350	19.3	88.3	207
2400	90.0	158.9	278

For the smallest resistance, the square of the current is about 4.7 times as great at resonance as when the capacity is changed by 50 micromicrofarads in either direction. For 9.4 ohms in circuit the ratio is about 1.8, and for the largest resistance only about 1.35. These calculated ratios agree very well with the experimental values. The close connection of the shape of

the resonance curve with its resistance points to the possibility of calculating the total resistance in the circuit from measurements of the resonance curve. For this method of measuring radio resistance see Circular 74 of the Bureau of Standards, Sections 49 and 50.

The calculations here given, as well as an inspection of the curves of Fig. 139, show that the resonance curve is not symmetrical. That is, the current has not the same value when the capacity is a certain amount less than the resonance value that it has when the value of the capacity is greater by the same amount. The question of this lack of symmetry is treated in the next section.

Symmetry of Resonance Curves.—The curves of Fig. 138 show the changes of coil reactance, curve *A*, and condenser reactance, curve *B*, together with the total reactance, curve *C* (their ~~show the changes of coil reactance, curve *A*, and condenser reactance, curve *B*, together with the total reactance, curve *C* (their~~ zero value (point *Z*, Fig. 138). The resonance peak (Fig. 139) is, therefore, unsymmetrical also. That is, the current is not the same for two frequencies, one slightly higher than the resonance frequency, and the other the same number of cycles lower than the resonance frequency. The explanation is found in the shape of the curve of condenser reactance.

The same lack of symmetry exists when the inductance and the frequency are held constant and the capacity is varied to obtain resonance, because the shape of the curve of condenser reactance in this case is the same as in the preceding. However, if the frequency and capacity are held constant, and the resonance condition is reached by varying the inductance, a symmetrical resonance peak is obtained; equal changes of the inductance above and below the setting for resonance will cause the current to fall to the same value. The difference of this case from the two preceding lies in the fact that curves of condenser and coil reactance and hence of total reactance are here straight lines.

To summarize, then, the resonance curve is symmetrical when the tuning is accomplished by varying the inductance (C and f constant), but is not symmetrical in the two other methods of tuning, viz, by varying the capacity (L and f constant) or by varying the frequency (C and L constant).

112. **The Wavemeter.**—The phenomenon of resonance enables one to obtain relatively large currents in a circuit to which only a small emf. is applied, provided only that the circuit is properly tuned. To determine when the condition for resonance is realized with a given frequency in a given circuit, or to measure the frequency at which a circuit of predetermined constants should be in resonance, use is made of the "wavemeter." This is the most important instrument used in radio measurements. It consists essentially of a series circuit, which includes an inductance and a capacity, both of which are of known values. Either the inductance or the capacity may be of fixed value, while the

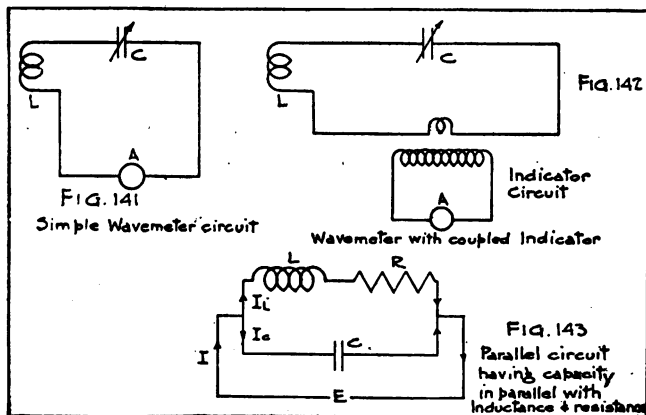

other will be variable. A hot-wire ammeter, thermo-junction, or other suitable device for measuring radio currents is inserted, either directly into the circuit (Fig. 141), or, better, is coupled electromagnetically to it, the coupling being made as loose (Sec. 119) as will permit of a suitable maximum deflection of the ammeter (Fig. 142).

If the frequency of the current in a given circuit is to be measured, the coil of the wavemeter circuit is placed near the circuit in question and the capacity of the wavemeter is varied until the indicating device shows that the current in the wavemeter circuit is a maximum. In making the final adjustment the wavemeter coil should be moved as far away from the circuit

in question as is possible and yet provide a convenient maximum deflection of the current-indicating device.

From the known value L of inductance of the wavemeter coil and the capacity C_r , corresponding to the setting of the condenser at resonance, the desired frequency may be calculated from equation (72), which gives

$$f = \frac{1}{2\pi\sqrt{LC_r}} \quad (72)$$

What is generally desired, however, is not so much the frequency as the wave length (Sec. 125) of the electromagnetic waves radiated by the circuit. The wave length λ is connected with the frequency f by the fundamental relation

$$\lambda = \frac{c}{f} \quad (73)$$

in which c is the velocity of electromagnetic waves in space and has the value of 300,000,000 meters per second. Expressing C_r in microfarads and L in microhenries, as is commonly convenient, the fundamental wavemeter equation giving the wave length in meters is

$$\lambda = 1884\sqrt{LC_r} \quad (74)$$

For example, if $L=1000$ microhenries and $C_r=0.001$ microfarad, the wave length emitted by the circuit is 1884 meters.

A wavemeter is usually provided with a buzzer or some other auxiliary device by means of which oscillations may be set up in the wavemeter circuit. These will have a wave length which may be calculated by equation (74) from the inductance and capacity of the wavemeter circuit. By coupling any desired circuit with the wavemeter circuit an emf. is introduced into the former, when the buzzer is working, the frequency of which is the same as that existing in the wavemeter circuit. This frequency may be calculated by (74) from the known inductance of the wavemeter coil and the capacity corresponding to the setting of the condenser. If, further, it is desired to tune the circuit in question to the frequency emitted by the wavemeter circuit, it is only necessary to connect a detector and telephones in the circuit to be tuned, to cause the wavemeter to emit waves, and to vary the capacity or inductance of

the circuit to be adjusted, until the sound of the buzzer in the telephones is a maximum.

113. **Parallel Resonance.**—In the preceding sections it has been shown how to obtain the maximum current in a circuit for a given applied emf. The principle of resonance, utilized for this purpose, finds application also in the solution of the reverse problem of keeping currents of a certain frequency out of any chosen part of a circuit without, however, preventing the passage of currents of other frequencies. To such an arrangement is given the appropriate name of a "filter." A filter consists essentially of an inductance coil, joined in parallel with a condenser. This combination is interposed between the emf. in question and that portion of the circuit from which the undesirable currents are to be excluded. Any such combination of inductance and capacity, taken at random, will oppose currents of a single frequency only, whose value depends principally on the values of the inductance and capacity. To render such an arrangement effective against currents of a certain chosen frequency it is necessary to adjust the capacity and inductance to have a definite relation. The solution of this problem requires a knowledge of the principles of "parallel resonance."

Fig. 143 shows a coil of inductance L and resistance R , joined in parallel with a condenser of capacity C . The current I flows from the alternating source of emf. E through the main circuit, and at the branch point divides, a part I_1 flowing through the coil and the remainder I_c through the condenser. At every moment the current I has a value which is the algebraic sum of the values of I_1 and I_c existing at that same moment. Let us suppose, first, that the emf. E has a definite frequency, and that the inductance of the coil is invariable. Current-measuring instruments may be arranged to measure the three currents. If the capacity is varied continuously and the indications of the ammeters recorded, the following experimental facts will be observed.

In general, the currents in the coil and condenser will be unequal, and the current I may be less than either. As the capacity is varied, the currents in the coil and condenser may be made to approach equality, and at the same time the main current will decrease. At length, for some critical value of the

capacity, the main current will reach a very small minimum value, while the current in the coil and the condenser current are nearly equal. Further, each is many times larger than the main current. As the capacity is now varied still further, the main current begins to increase, and the coil and condenser currents are no longer so nearly equal.

As an example, assume the inductance of a coil to be 1000 microhenries and its resistance 2 ohms. An effective emf. of 10 volts and a frequency of 71,340 cycles per second is applied. (This value of frequency was chosen, since it gives a minimum current I , with a condenser of almost exactly 0.005 microfarad.) The changes of the current in the main circuit, as the capacity is varied from 0.002 to 0.008 microfarad are shown in Fig. 144, in which values of the capacity are measured horizontally and values of the square of the current vertically. The latter values in the figure are multiplied by a million. The minimum current is not zero, but its value is only about 0.0001 ampere, a value whose square is too small to be easily distinguished in the figure. The corresponding currents in the coil and condenser are each about 0.02236 ampere. Their difference is only about $\frac{1}{100,000}$ part of this value, the condenser current being the larger by this minute amount.

In practice, then, if we imagine some troublesome emf. to be introduced into the circuit at E (Fig. 143), by induction or otherwise, the employment of a parallel combination of inductance and capacity can be made to very completely prevent this emf. from causing currents to flow in the circuit, provided only that the values of inductance and capacity are properly chosen. And such a filter does not prevent the passage of currents of other frequencies.

If, for example, we suppose that the emf. E has a frequency of 100,000 cycles, in the above case the combination of 1000 microhenries and 0.005 microfarad would allow 0.01549 ampere to flow in the main circuit. That is, this filter has 155 times as much stopping effect for currents of 71,340 cycles per second as for currents of 100,000 cycles, and for frequencies further away the effect would be greater. Filters of this kind are used in airplane radio telephone sets to remove noises produced by the electric generator used in the set; for example, in the type

SCR-68 sets. A similar filter is used in connection with the Signal Corps buzzerphone, type EE-1.¹ Filters are also used in telephony on wires using modulated radio-frequency currents. (See Sec. 212.) Filters designed for this purpose may consist of an elaborate arrangement of a considerable number of inductances and capacities.

The results of theory show that to filter out currents of a frequency f , the necessary relation between inductance and capacity is given in the following equation:

$$C = \frac{L}{R^2 + (2\pi fL)^2} \quad (75)$$

The current in the main circuit is, under this condition,

$$I = \frac{ER}{R^2 + (2\pi fL)^2} \quad (76)$$

In all practical radio circuits, however, the resistance of a circuit is so small in comparison with the inductive reactance, that it may be neglected. The equation (75), under these circumstances, goes over into the same equation that holds for series resonance, that is—

$$2\pi fL = \frac{1}{2\pi fC}$$

Otherwise expressed, then, it may be stated that when the condition of parallel resonance is realized, the loop circuit which contains the coil and condenser in series is very closely in a condition of series resonance. Recalling the fact that, in the series resonance condition, the emf. on the condenser is equal and opposite to that on the coil, it is easy to see that there is here a flow of current back and forth between the coil and the condenser. Viewed from the main circuit (Fig. 143), the current in the coil is, at every moment, opposite to the condenser current, so that the main current, which is their algebraic sum, is at every moment merely the difference between the condenser and coil currents. These latter being nearly equal in value, we have the explanation of the existence of the relatively large currents in the coil and condenser, when the main circuit is almost free from current.

¹ See Signal Corps Wire Communication Pamphlet No. 1 (see p. 576).

The ideal filter would be one in which the resistances of the inductance coil and all the connecting wires in the two branch circuits were actually zero. In such a case, the condition for parallel resonance would be rigorously the same as for series resonance, equation (70), the condenser current would be exactly equal to the current in the coil, and absolutely no current would flow in the main circuit. The filter effect would be perfect. No energy would therefore flow from the source E ,

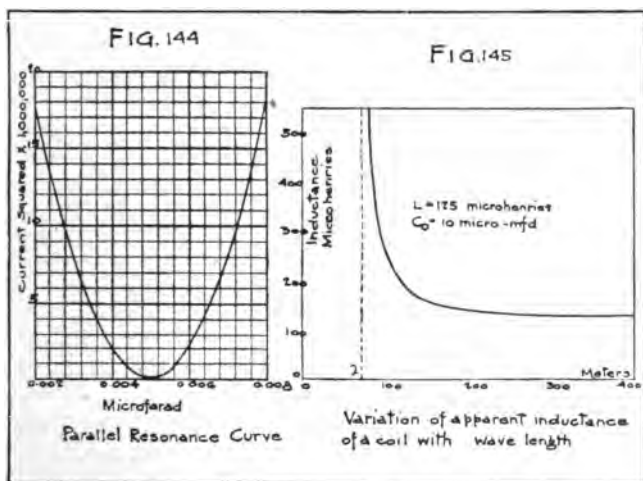

but this would merely give the condenser an initial charge, and thereafter current would flow between the two branch circuits, even if the main circuit were removed. See Section 115, on free oscillations.

In any actual case there must, however, be some resistance in the circuit, and the energy for the heating in the resistance must come from outside. The emf. E must cause just enough current to flow in the main circuit to make good this loss of energy. It is easy to show that these conclusions follow also from the equations previously cited. When the resonance condition is established, the main current and the emf. E are in phase, so that the power is equal to the product of the emf. E

and the main current—that is, to $\frac{E^2 R}{R^2 + (2\pi f L)^2}$. The power lost in heating is equal to the square of the current in the coil multiplied by the resistance of the coil. The current in the coil is, however (Sec. 55), $\frac{E}{\sqrt{R^2 + (2\pi f L)^2}}$, so that the power in

heating has the value $\frac{E^2 R}{R^2 + (2\pi f L)^2}$, as before. The fact that the main current should be zero, when the resistance is zero, is in line with equation (76) for I , and with the fact also that the heating must be zero in that case.

Besides tuning the filter by varying the capacity, it is of course possible to obtain parallel resonance by varying the inductance instead. For a given coil and condenser, it is also possible to obtain parallel resonance by adjusting the frequency of the applied emf. It must be noted, however, that when either the inductance or the frequency is varied, the conditions for minimum current in the main circuit are slightly different and are not the same as when the capacity is varied. These three conditions differ appreciably only when the resistance is large. For radio circuits, the resistance is usually so small that no difference can experimentally be detected between all these conditions for minimum current. For zero resistance, all three coincide and are expressed by equation (75).

114. Capacity of Inductance Coils.—A coil used in radio circuits can seldom be regarded as a pure inductance. While the capacities between turns of a coil are small, they approach the same magnitude as other capacities used in radio circuits. A coil is to be considered as a combination of inductance and capacity in parallel. It is found that the capacity C_0 of a coil does not change appreciably with frequency. Neither does the inductance itself, but the apparent or equivalent inductance L_a of this combination of inductance and capacity does vary with frequency as indicated by the equation

$$L_a = \frac{L}{1 - \omega^2 C_0 L} \quad (77)$$

in which the quantity ω is equal to $2\pi f$. (See p. 123.) The variation with wave length is shown in Fig. 145. When the coil is the main coil of a circuit, it is usually desirable to

introduce the emf. into the circuit by induction in the coil itself rather than in series with the coil. The capacity of the coil is then merely added to the capacity of the condenser. When the emf. is in series with the coil, one effect of the coil capacity is to increase the resistance introduced into the circuit by the coil and thus reduce the current.

The capacity of coils frequently gives rise to peculiar and undesirable effects in radio circuits. Among these are effects caused by the capacities of those parts of a coil which are not connected in the circuit. The turns which are supposedly "dead" may actually produce considerable effect, both upon the resistance and frequency of resonance of the circuit. Thus, the capacity of the unused part 2 of the coil in Fig. 146 causes a second circuit to be closely coupled to circuit 1. This may cause the circuit 1 to respond to two frequencies and exhibit the other phenomena of coupled circuits described in Section 120 below. (See also Circular 74 of the Bureau of Standards, Sec. 19; Bureau of Standards Scientific Paper No. 427, by G. Breit, "Some Effects of the Distributed Capacity Between Inductance Coils and the Ground"; and also a paper by G. Breit, "The Distributed Capacity of Inductance Coils," *Physical Review*, vol. 17, pp. 649-677, June, 1921.)

B. Damping.

115. **Free Oscillations.**—Thus far it has been assumed that a constant alternating voltage has been applied to radio circuits, in which case the alternating currents produced are of constant amplitude. Such currents may be regarded as analogous to the forced oscillations which are produced in a mechanical system like a swing or a pendulum, when it is acted upon by a force which varies periodically. The system is forced to vibrate with the same frequency as that of the force.

It is, however, possible to produce oscillations of current in a circuit without the necessity of providing a source of alternating emf. A common method is merely to charge a condenser and then to allow it to discharge through a simple radio circuit.

This may be accomplished, for example, by the simple means shown in Fig. 147. By throwing the switch *S* to the left, the condenser *C* is charged by the battery *E*, but when the switch is thrown to the right, it is discharged into the circuit contain-

ing the resistance R and the inductance L . If the resistance R is not too great, electric oscillations are set up which, however, steadily die away as their energy is dissipated in heat in the resistance. As in Fig. 148, the current becomes less and less as the oscillations go on.

To explain this action, we must follow more closely what takes place in the circuit from the moment when the condenser, charged up to a certain potential difference, is inserted in the discharge circuit. When the condenser starts to discharge itself, a current flows out of it, and the potential difference of the plates decreases as a result. At the moment when the plates have reached the same potential, current is still flowing out of the condenser. The current has energy and can not be

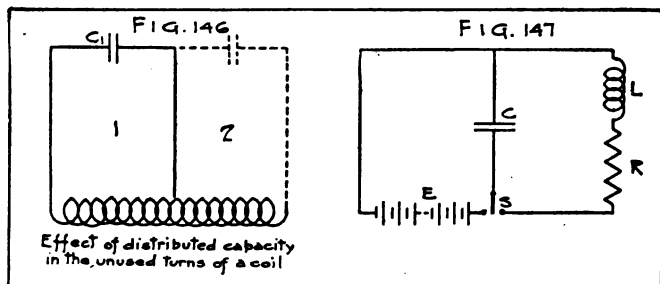

stopped instantly. In fact, to bring the current to zero value it is necessary to oppose it by an emf., and the amount of emf. necessary is greater the more quickly one wishes to stop the current. It is similar to the case of a moving body. On account of its motion the body possesses energy, and can not be brought to rest instantly. The greater the force which is opposed to it, the more quickly it may be brought to rest, but unless its motion is opposed by some force, it continues to move indefinitely without change of velocity.

The flow of current from the condenser, then, does not cease when the condenser has discharged itself, and, as a result, that plate which was originally at the lower potential takes on a higher potential than the other. The condenser is beginning to charge up in the opposite direction. The potential difference of the plates now acts in such a direction as to oppose the flow

of the current, which decreases continually as the potential difference of the plates rises. If the resistance of the circuit were zero, the current would be zero (reversing) at that moment when the potential difference of the plates had become just equal to the original value. That is, the condenser would

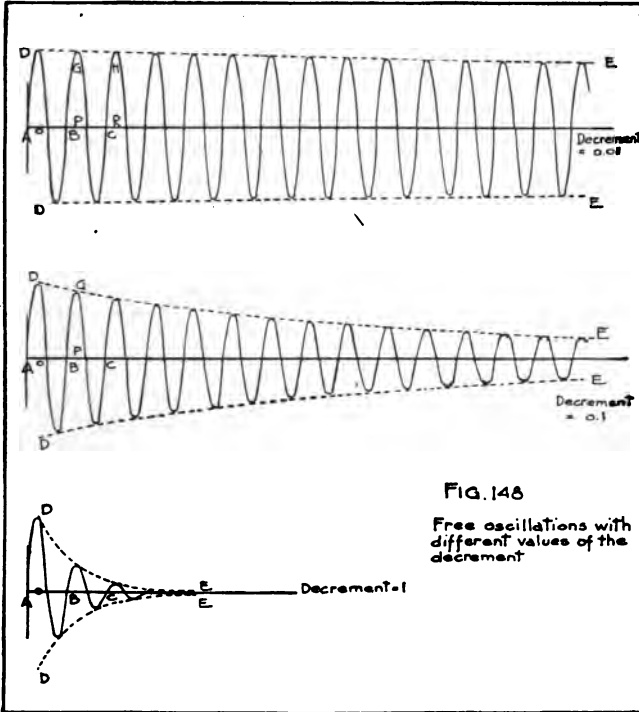

be as fully charged as at the beginning, only with the potential difference of the plates in the direction opposite to that at the start. Now begins a discharge of electricity from the condenser in the opposite direction to the first discharge, and this discharging current flows until the condenser has become fully recharged in the original direction. The cycle of operations then repeats itself, and so on, over and over again.

The action in the circuit may thus be described as a flow of electricity around the circuit, first in one direction and then in the other. The rate of flow (current) is greatest when the plates have no potential difference, and the current becomes zero and then begins to build up in the opposite direction at the moment when the potential difference of the plates reaches its maximum value. This alternate flow of electricity around the circuit first in one direction and then in the other is known as an "electrical oscillation." Since no outside source of emf., such as an a.c. generator, is acting in the circuit, the oscillations are said to be "free" oscillations.

Mechanical free oscillations are well known. Such, for example, are the swinging of a pendulum and the vibration of a spring which has been bent to one side and then let go. In the case of the pendulum the velocity with which it moves corresponds to the value of the current in the electrical case, while the height of the pendulum bob corresponds to the potential difference of the condenser plates. When the bob is at its highest point its velocity is zero, corresponding to the condenser when the plates are at their maximum potential difference and no current is flowing. When the pendulum bob is at its lowest position it is moving most rapidly. Similarly, when the plates of the condenser have zero potential difference, the current flowing has its maximum value. The pendulum does not stop moving when it passes through its lowest point; neither does the current cease at the moment when the condenser plates are at the same potential. The pendulum rises with a gradually decreasing velocity toward a point at the other end of the swing as high as the starting point. The current gradually decreases as the condenser charges up to an opposite potential difference equal to the original value. The return swing of the pendulum corresponds to the flow of current in the direction opposite to the original discharge.

A pendulum swinging in a vacuum and free from all friction would continue to swing indefinitely, each swing carrying it to the same height as the starting point. Similarly, electric oscillations would persist indefinitely in a circuit—that is, they would be "undamped" if there were no resistance to the current.

Actually, electric oscillations die down in a circuit and finally cease altogether, just as an actual pendulum will make shorter

and shorter swings and finally come to rest. Since the occurrence of free oscillations in a circuit presupposes no interference with the circuit from outside, the circuit receives no energy beyond that imparted to it at the moment when the oscillations begin. Thereafter the circuit is self-contained, and any loss of its energy in heat and electromagnetic waves reduces by just so much the energy available for maintaining the oscillations. This loss of energy goes on continuously and the oscillations die away to nothing. They are said to be "damped" oscillations.

At the start there is a definite amount of energy present in the circuit, namely, the energy of the charge given the condenser. The amount of this energy depends upon the capacity of the condenser and the square of the potential difference between its plates (emf. to which it is charged). This energy exists in the dielectric of the condenser, which is in a strained condition due to the charge. As soon as the current begins to flow the condenser gives up some of its energy, and this begins to be associated with the current and is to be found in the magnetic field around the current; that is, principally in the region around the inductance coil. As the current rises in value under the action of the emf. of the condenser, energy is continually leaving the condenser and being stored in the magnetic field of the inductance coil. When the plates of the condenser have no potential difference, the whole energy of the circuits resides in the magnetic field of the coil and none in the condenser. Energy is then drawn from the coil as the current decreases and energy is stored up in the condenser as it is recharged.

If the resistance of the circuit were zero and no energy were radiated in waves or dissipated in other ways, the total energy of the circuit would be constant. The energy dissipated in heat and electric waves is, however, lost to the circuit, so that the total amount of energy, found by adding that present in the condenser to that in the inductance, steadily decreases. Finally all the original store of energy given the circuit has been dissipated and the oscillations cease.

The energy lost when a steady current is flowing in a circuit depends not only on the value of the current, but on the resistance of the circuit, and in a radio circuit this resistance is replaced by a somewhat larger quantity of the same kind, the "effective resistance." (See Sec. 117.) The greater the effec-

tive resistance the greater the amount of energy dissipated per second when a given current flows.

Ohm's law shows that to keep a current I flowing through a resistance R an emf. RI is necessary and this has to be furnished by the battery, generator, or other source. In an oscillating circuit the same is true, and that portion of the emf. in the circuit which is employed in forcing the current against the resistance is, of course, not available for charging the condenser or building up the discharge current. The changes of current in the circuit described above are thereby hindered, and the current does not rise to as great a value as it would in the absence of resistance. The maximum of emf. between the plates of the condenser is less each time the condenser is discharged, and thus the oscillations of the current die away.

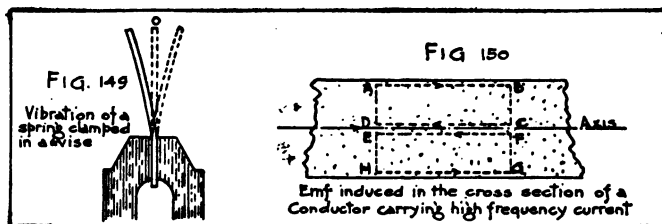

A good analogy to damped electrical oscillations in a circuit is found in the vibrations of a flat spring, clamped at one end in a vise, and then bent to one side and released, Fig. 149. The spring vibrates from side to side with decreasing amplitude, until finally it comes to rest in its unbent position O . When the spring is bent energy is stored up in it—the energy of bending. On being released the spring moves and gains energy of motion, while the energy of bending decreases. If there were no friction the loss of one kind of energy would be just offset by the gain of the other kind and the sum total would remain constant. The spring would move past the natural undisturbed position O , under the influence of its energy of motion, and would be brought to rest at a position just as far to the other side of O as was the starting point.

Friction has, however, the effect of opposing the motion and causing a dissipation of energy in heat, and each excursion away from the resting point is smaller than the one preceding.

Free oscillations, then, can take place in a circuit containing inductance and capacity. These would be undamped in the ideal case where the resistance can be regarded as zero. In all practical cases of free oscillations, however, the oscillations are damped. To produce undamped waves it is necessary to provide some source of power to make good the energy dissipated in the oscillating circuit. Strictly speaking, undamped free oscillations are impossible in actual circuits. It is of importance to study the effect of the resistance in determining the rapidity with which the oscillations die away.

116. **Frequency, Damping, and Decrement of Free Oscillations.**—If the resistance of the oscillating circuit is constant it is possible to calculate the period of the free oscillations in the circuit and to find the rate at which the oscillations die away. If L , C , and R are, respectively, the inductance, capacity, and resistance of the circuit, then free oscillations in the circuit will have the frequency

$$f = \frac{1}{2\pi} \sqrt{\frac{1}{LC} - \frac{R^2}{4L^2}} \quad (78)$$

This is known as the "natural frequency" of the circuit. Similar considerations apply to the pendulum and vibrating spring discussed above. Each vibrates in a period natural to it, which depends upon the dimensions, material of the vibrating system, and the friction against which it moves.

If it should happen, in any case, that the quantity $\frac{R^2}{4L^2}$ is equal to or greater than $\frac{1}{LC}$ then free oscillations in the circuit are impossible; the current in the circuit does not reverse its direction at all, but simply dies away. The circuit is said to be in the "aperiodic" condition; that is, without period. Seldom do such cases occur in radio circuits. Usually the quantity $\frac{R^2}{4L^2}$ instead of being larger than $\frac{1}{LC}$ is very small in comparison with the latter. We may, therefore, as a rule, use without error as the expression for the natural period

$$f = \frac{1}{2\pi\sqrt{LC}}$$

which is the same expression as for the frequency of the applied

emf. necessary in order that the circuit shall be in the resonance condition.

The rapidity with which the oscillations die away depends, not only on the resistance of the circuit, but on the inductance also. The greater the resistance and the smaller the inductance, the more rapid is the damping and the rate at which the oscillations decrease. If the resistance, capacity, and inductance of the circuit have fixed values, it may be shown that each successive maximum of current is the same fraction of the preceding maximum as the latter is of the maximum immediately preceding it. If, for example, the second maximum is 0.9 of the first, the third will be 0.9 of the second, etc. However, instead of adopting as a numerical measure of the rate of decrease this ratio itself, it is found more convenient in the mathematical theory of damping to adopt the natural logarithm of the ratio of any maximum to the next following maximum with the current in the same direction, i. e., the logarithm of the ratio of two maxima one cycle apart. This number is known as the "logarithmic decrement," or "decrement," for short. This is the decrement per complete oscillation.

In cases where the resistance of the circuit is not exceedingly large, the decrement is equal to π times the quotient of the resistance by the inductive reactance of the circuit, calculated for the natural frequency of the circuit. That is, the decrement is equal to $\pi \left(\frac{R}{2\pi fL} \right)$, so that either increasing the resistance or decreasing the inductance will increase the decrement. The natural frequency being practically independent of the resistance, that is, equation (79) being sufficiently accurate, the capacitive reactance is equal to the inductive reactance. Thus the decrement is π times the quotient of the resistance by the capacitive reactance at the natural frequency of the circuit.

In a spark circuit the idea of logarithmic decrement is not exactly applicable. On account of the variable resistance of the spark, the oscillations fall off according to a different law than that just discussed. (See Circular 74, p. 230.)

Examples of Decrements.—Fig. 148 gives a graphic idea of the dissipation of the oscillations in three cases where the decrements are 0.01, 0.1, and 1. These correspond to circuits of very

small damping, moderate damping, and excessive damping, respectively. Each curve starts from the same value of current at the first maximum, and for each the natural period of the circuit is the same. The latter is represented by the horizontal distance, AB , BC , etc., in each. The difference between the curves is striking. In the case of a decrement of 0.01, the oscillations decrease only very gradually; this case approximates that of undamped waves. In the extreme case of a decrement of 1, the oscillations become negligible after only four or five periods. To construct such curves the following simple method may be used:

Assume a certain number of divisions in the horizontal direction to represent the period of the oscillations, for example, five. Then the curve must cross the horizontal axis every two and one-half divisions. Choose a convenient number of divisions to represent the first maximum of the current, for example, ten. The curves DE (Fig. 148) are next drawn to scale, starting with the chosen value for the first maximum. The curves DE have the property that the height of the curve falls off by equal fractions of its value for equal horizontal intervals.

For instance, if the decrement is 0.1, we find, since 0.1 is the natural logarithm of 1.105, that the first maximum OD in the positive direction is 1.105 times as great as the next, PG , and so on for any two successive maxima in the same direction. If, therefore, we take $OD=10$ divisions, PG will equal $\frac{10}{1.105}=9.05$ divisions, RH will be $\frac{9.05}{1.105}=8.19$, etc.

For all except large values the logarithmic decrement is practically equal to the fractional difference between successive maxima. Thus, for example, when the logarithmic decrement is 0.1 each maximum is approximately 0.1 greater than the next.

Number of Oscillations.—Although, strictly speaking, the oscillations never would become absolutely zero, they actually become negligible after a certain time. A knowledge of the logarithmic decrement enables us to calculate how many complete oscillations will be executed before their amplitude has

fallen below a certain fraction of the first oscillation. This number is greater the smaller the decrement.

If, for example, we arbitrarily choose to find the number of oscillations which will be completed before the maximum of current will fall below 1 per cent of the value at the start, we have simply to take the quotient of the natural logarithm of 100 by the decrement. The natural logarithm of 100 is, near enough, 4.6. The number of oscillations is thus 4.6 divided by the decrement. Thus in the three cases given in Fig. 148 the numbers of complete oscillations will be 460, 46 and 4.6, corresponding to the decrements 0.01, 0.1, and 1, respectively.

The maximum possible value of decrement would be infinite, but the United States radio laws² require that values greater than 0.2 shall not be used on account of the interference of highly damped stations with other stations. The number of complete oscillations calculated by the above rule is 23 for a decrement of 0.2. The ratio of two successive current maxima for a decrement of 0.2 is about 1.22.

Effect of Decrement on Tuning.—The decrement of a transmitting set gives an approximate idea of its effectiveness in generating oscillations of a definite wave length, and in delivering its energy at the wave length which it is desired to use. The smaller the decrement the sharper the tuning possible and the less the chance of interference with stations tuned to a different wave length. The reason for this is that with highly damped waves there are fewer radio-frequency oscillations per wave train than with slightly damped waves, with the result that in the former case the tuning of a receiving circuit to the wave length of the emitted radio-frequency oscillations has less effect in determining how much current will be built up in that receiving circuit. Let us compare two wave trains having the same energy content, one being highly damped and the other only slightly damped. In the former there will be a smaller number of waves between the same relative values of amplitude in a wave train than in the latter, and the energy and the electric impulse in the earlier waves of the highly

² See the pamphlet *Radio Communication Laws of the United States*, issued by the Bureau of Navigation, Department of Commerce. Copies may be secured from the Superintendent of Documents, Government Printing Office, Washington, D. C., for 15 cents each.

damped wave train will be greater than in the slightly damped wave train. Also the electric impulse in the successive waves of the highly damped train will differ considerably, while the electric impulse in the successive waves of the slightly damped train will be almost the same. The first wave of the highly damped train will have a large electric impulse and will also have a considerably larger electric impulse than the one following it. This first large electric impulse can be thought of as producing a large response—that is, forcing a current in a system which is not exactly in tune with it. Even if the second impulse should act on the receiving system at an instant such that its effect would tend to diminish the effect of the first, nevertheless since the first impulse was so much greater than the second the current in the receiving system would not cease on account of the counteracting effect of the second impulse. Hence if a highly damped wave train acts on any receiving circuit, that circuit will respond to the first incoming waves of the train and will maintain oscillations at the frequency to which the receiving circuit happens to be tuned. (See Impulse Excitation, Sec. 123.) In the case of the weakly damped wave train, each impulse is comparatively small and has nearly the same impulsive force; the first impulse will produce a small response which could be annulled by the second impulse if it should act on the receiving system at an instant such as to oppose the effect of the first impulse. Since each impulse is small and has nearly the same value, the cumulative effect of a number of impulses must be utilized, which means that the transmitting and receiving systems must be closely in tune.

In Fig. 148 the emitted wave train having a decrement of 0.1 will cause an appreciable response only in such receiving circuits as are approximately tuned to the radio frequency of the emitted wave. The wave train having a decrement of 1.0 will cause an appreciable response in nearly all receiving circuits which it has the power to affect at all by simply applying to them a series of impulses of the train frequency. A wave train having a decrement of 10 would have only one-half of an oscillation of appreciable magnitude and would have no tuning properties whatever in a receiving circuit.

Thus, even if the total power of the oscillations be the same in both cases, a transmitter which sends out a certain number

of waves trains per second, each wave train having 20 oscillations of large amplitude at 600 meters, will be much more apt to interfere with a receiver tuned to 800 meters than if the transmitter sent out the same number of wave trains per second each of which had 100 oscillations of less amplitude at 600 meters.

This can be roughly illustrated by the familiar example of resonance in sound. Tuning forks usually persist a considerable time in their vibration. This means that their vibrations are weakly damped and that any one single oscillation in the sound wave which they emit will have comparatively small energy content. If a tuning fork having a frequency of 512 vibrations per second is to cause another tuning fork to respond by the action of sound waves, it is necessary that the two forks have nearly the same vibration frequency. However, the single blow with the hammer which started the 512 fork vibrating will also start a 900, 1200, or 3000 fork. The single blow with the hammer which would start all of these forks can be thought of as corresponding to the strong impulse of the first wave of a very highly damped wave train.

Another illustration of this application of the principle of resonance is found in a suspended swing. A small child by feeble but well-timed impulses can gradually swing his playmate high into the air, providing friction is very small, that is, providing the hinges of the swing are well oiled. The swing will reach the greatest height if the frequency of the impulses is the same as the natural frequency which the swing would assume by itself if given a single strong initial impulse. If the hinges are rusty, it will be very difficult if not impossible to work the swing up to its full height by feeble impulses no matter how well timed; this condition corresponds to the case of highly damped oscillations. If the hinges are very rusty, it may be necessary to give an initial impulse sufficient to send the swing to its full height on the first swing; this corresponds to the case of impulse excitation, which gives waves which will cause response in every receiving circuit which they reach at all without regard to the wave length to which the receiving set may be tuned.

Modulated Continuous Waves.—If a continuous or undamped radio-frequency wave, such as that produced by an electron

tube generator, is modulated at a low frequency, as in radio telephony, it may cause interference over a wide range of tuning adjustments, behaving in this respect much the same as a damped wave of appreciable decrement. This effect is discussed in Section 206, page 514.

C. Resistance.

117. **Resistance Ratio of Conductors.**—When a steady emf. is applied between the ends of a conductor, the current quickly rises to the final Ohm's law value, and distributes itself uniformly over the cross section of the wire. During the interval between the moment when the emf. is applied, and the moment of attainment of the final steady state, the current distribution over the cross section is not uniform. This effect is due to self-induced emfs. in the cross section of the conductor. Suppose that a section be taken through the axis of a cylindrical conductor and that the applied emf. tends to produce a current in the direction of the arrow (Fig. 150). The magnetic lines in the cross section will be circles, in planes at right angles to the axis, and with their centers in the axis. In the figure, the lines will be directed out of the paper in the region above the axis and into the paper in the region below the axis. As the total current rises in value, the number of lines of force through any portions of the cross section, such as *ABCD* and *EFGH*, will be increasing, and by Lenz's law (Sec. 45) this change of field will give rise to induced emfs. which tend to oppose the changes of the field. The directions of these induced emfs. will accordingly be those indicated by the small arrows, and it is easy to see that the increase of the current is aided in those portions of the cross section which lie near the surface of the conductor, and hindered at the portions nearer the axis. That is, the current reaches its final value later at the axis of the cross section than at points on the surface of the wire. On the other hand, if the circuit is broken after the distribution of current has reached the uniform state, the outer portions of the conductor will first be free from current.

These effects may be accurately described by the statement that the current grows from the outer layers of the wire inward, and that the current inside the conductor attains the

same value as that at the surface, only after a finite interval of time.

When a rapidly alternating emf. is impressed upon the conductor, (a) the phase of the current inside the conductor lags behind that of the current at the surface by an amount which is greater the nearer the point is to the axis; and (b) the amplitude of the current is largest at the surface and decreases as the axis is approached because sufficient time has not been allowed for the final steady value to be reached before the emf. was changed. This non-uniformity of current distribution in the cross section is known as the "skin effect," and it is equivalent to a reduction of the cross section of the conductor with consequent increase in its resistance.

From these considerations, it will be seen that in addition to its dependence on the frequency, the skin effect will be more serious, the thicker the conductor and the greater the permeability and conductivity of the material of which it is composed; for the thicker the conductor, the longer the interval which must elapse before a change in emf. will be felt at the center of the conductor and thus the greater the difference in the current density at different points of the cross section. With given dimensions, the greater the permeability of the wire, the greater the emf. induced in its mass. The better the conductivity, the less the ratio of the effective current to the value at the surface.

A numerical calculation of the magnitude of the skin effect can be made only in a few special cases for which Circular 74, pages 299-308, should be consulted. Table 18 of Circular 74 will enable one to see at a glance how great diameter of wire is allowable, in order that the increase of resistance due to skin effect shall not exceed 1 per cent of the direct current value. Such data are of use in estimating the size of wire suitable for a hot-wire ammeter, in order that its resistance may not vary in the range of frequency for which it is intended. For larger diameters of wire the effect increases rapidly, and cases where the high-frequency resistance is five to ten times the direct current value are not rare. These facts must be kept in mind when estimating the current carrying capacity of a conductor. The "resistance ratio" is defined as the ratio of resistance at the frequency in question to the resistance to direct current. Then, for the same heating, the allowable current at the high fre-

quency will be less in the ratio of the square root of the resistance ratio.

In Appendix 4, page 556, is given a table of values of the resistance of various sizes of solid copper wire at a frequency of 1,500,000 cycles per second.

Since the skin effect tends to render useless for the carrying of the current the inner portions of the cross section of a wire, thin tubing, or a thin layer of good conducting material plated or welded on the surface of a poor conducting cylinder is a form of conductor suitable for carrying currents of radio frequency. In fact, tubing which is very thin in comparison with its radius has for the same cross section a smaller high-frequency resistance than any other single conductor.

To reduce the skin effect, a conductor is often built up of a number of very fine conducting strands. The resistance ratio of such a combination is, however, on account of the mutual inductance of the strands, appreciably greater than the resistance ratio of one of the strands. To be effective, the strands should be placed as far apart as practicable, and the diameter of the individual strands should not exceed about 0.1 mm. The individual strands are usually enameled and the conductor is usually so constructed that each strand comes to the surface or very near the surface at regular intervals. If the individual strands are not enameled, a stranded conductor may at high frequencies have a resistance considerably greater than the resistance of the corresponding solid conductor. In a stranded conductor carrying radio-frequency current, in a given cross section different strands have different potentials, and if the strands are not enameled current will flow across contacts of appreciable resistance between individual adjacent strands, and energy will be lost as heat and the effective resistance of the conductor will be increased. The most effective form of stranded conductor, although expensive to make, is one where the strands are so twisted as to form a woven tube. For further particulars see pages 306-308, of Circular 74.

Effective Resistance.—The resistance of a circuit at high frequency is never the same as the resistance measured by direct current. To define what is meant by the resistance at high frequencies, we have to divide the power lost in heating or otherwise dissipated, by the square of the effective current. This

quotient is known as the "effective resistance" at the frequency in question.

The effective resistance of a circuit carrying currents of radio frequency may be very appreciably affected by the presence of neighboring conducting bodies. The energy of any eddy currents which may be induced in the latter is drawn from the circuit in question, whose effective resistance is thereby increased. On account of the high frequency, this effect can be astonishingly large in good conductors and may be appreciable in the presence of such a poor conducting path as a painted surface.

Different portions of the same circuit should not be placed in close proximity. The mutual effects of the currents which flow in opposite directions in two parallel cylindrical wires is, for example, such as to cause the maximum current densities in the two cross sections to be shifted to points nearer the other conductor, with an increase in the effective resistance of each conductor above the value it would possess in the absence of the other. In other cases (p. 302, Circular 74) the effective resistance may be reduced by the presence of the other lead. An important example of the effect of the mutual inductance of neighboring conductors on their effective resistances is furnished by a system of parallel wires connected in parallel. In this case more current, at radio frequencies, flows in the outer wires than in the inner, and the differences may become very important. This is a point which cannot be overlooked in the design of hot-wire ammeters to carry large currents.

118. Brush, Spark, Dielectric, and Radiation Resistance.—As has already been explained (Secs. 31 and 56), no dielectric is perfect. Some heating takes place in it, and we may artificially represent a condenser as equivalent to a pure capacity in series with a resistance. The introduction of a condenser into a radio circuit has therefore the effect of increasing the effective resistance of the circuit, and, except in especially designed air condensers, this effect cannot be neglected. Care needs therefore to be taken that poor dielectric materials be kept away from regions of intense electric field.

When operating condensers at high voltages, large energy losses may occur in the so-called brush discharge, and this

effect will generally give rise to a very considerable increase in the effective resistance of the condenser.

If a spark gap is included in a circuit, the resistance of the spark will have to be included in the total effective resistance of the circuit. This spark resistance depends upon a number of circumstances, and the laws of its variation are very complex. In general, a short spark gap has a larger conductivity per unit length than a long one. Thus a series of short spark gaps is better than a single one of a length equal to the sum of the lengths of the shorter gaps. The pressure and nature of the gas between the terminals also affect the resistance which is materially decreased with reduction of pressure. Further, the nature of the terminals and the constants of the remainder of the circuit all affect the spark resistance.

Some of the power supplied to a circuit, which is carrying a radio current, is radiated from the circuit in the form of electromagnetic waves (see Chap. 4). This may be regarded as the useful work obtained from the circuit, and for transmission purposes the power radiated should be made as large as possible, in comparison to the power dissipated in the circuit itself and in its immediate surroundings. The power radiated at any frequency is found to be proportional to the square of the current flowing, so that the radiative effect may be regarded, artificially, as causing a definite increase in the effective resistance of the circuit. This fictitious resistance increase is known as the "radiation resistance," and is found to be directly proportional to the square of the frequency, or inversely proportional to the square of the wave length.

D. Coupled Circuits.

119. **Kinds of Coupling:**—When two circuits have some part in common or are linked together through a magnetic or an electrostatic field they are said to be "coupled." If two circuits have an inductance coil in common (Fig. 151a), their relation is said to be "direct inductive coupling." If they have a condenser in common, their relation is said to be "direct capacitive coupling" (Fig. 151c). If they have a resistance in common, their relation is said to be "resistance coupling."

If two circuits are mutually inductive (Fig. 151b) and have no part in common other than the mutual inductance, their relation is said to be "indirect inductive coupling," usually called simply "inductive coupling." (For mutual inductance see also Sec. 47.) Sometimes the coupling shown in Fig. 151c is modified by using two additional condensers. Each circuit contains two condensers in series and one condenser in the first circuit is coupled to one condenser in the second circuit through a coupling condenser; this is described as "indirect capacitive coupling." Mutual inductive coupling is used very extensively in constructing radio apparatus. It often happens that the two coils constituting a mutual inductance are so mounted that they also constitute the two plates of a condenser whose capaci-

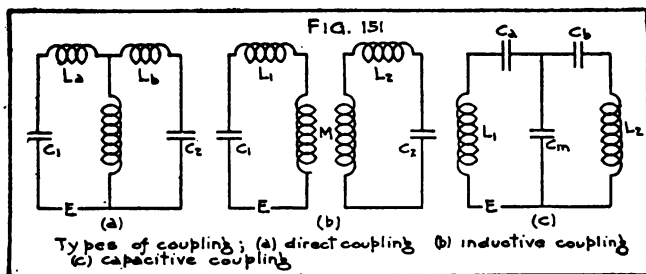

tive reactance is appreciable at radio frequencies, and in this case the effect of the coupled coils is a combination of inductive coupling and capacitive coupling.

It is customary to denote as the "primary" that circuit in which the applied emf. is found, the other being regarded as the "secondary" circuit. When two circuits are coupled they react on one another so that the current in each circuit is not the same as would be the case were the other circuit absent. The extent of the reaction is, however, very different in different cases. Circuits are said to be "closely coupled" when any change in the current in one is able to produce considerable effects in the other. When either circuit is little affected by the other the coupling is regarded as "loose." The coupling between two inductively coupled circuits is changed by changing the distance between the two coupling coils. In general, increas-

ing the distance between the two coils will make the coupling looser, providing each coil is moved parallel to its original position. If the distance between the two coils is not changed, but they are moved so that the angle between their projected axes is changed, the coupling will also be made looser, since fewer lines of force are then linked with both coils.

A more exact measure of the closeness of the coupling is given by what is called the "coefficient of coupling" (denoted by k). Its value in the case of direct coupling (Fig. 151a) is given by

$$k = \frac{M}{\sqrt{(L_a + M)(L_b + M)}} \quad (80)$$

If the total inductances of the circuits in Fig. 151b are denoted by L_1 and L_2 , we have for inductive coupling

$$k = \frac{M}{\sqrt{L_1 L_2}} \quad (81)$$

and for capacity coupling (Fig. 151c.)

$$k = \sqrt{\frac{C_a C_b}{(C_a + C_m)(C_b + C_m)}} \quad (82)$$

As the coupling is made very loose, k approaches zero as its limit; for the closest possible coupling k would be unity.

In equations (80) and (81) the values of M , L_a , L_b , L_1 , L_2 , must be expressed in the same units. In equation (82) the values of C_a , C_b , C_m must be expressed in the same units.

The coupling of two direct coupled circuits may be increased by increasing the amount of inductance which is common to the two circuits, maintaining constant the total inductances ($L_a + M$) and ($L_b + M$) of the two circuits. To make the coupling of the inductively coupled circuits closer, their mutual inductance is increased by moving the coils nearer or by increasing the inductance of either coil. For example, the coefficient of coupling of an antenna may be increased by adding turns to the coil of the oscillation transformer, enough inductance being subtracted from the loading coil to keep the total inductance of the circuit constant. Capacitive coupling is closer, the smaller the common capacity C_m is in comparison with the capacities C_a and C_b .

In some types of receiving apparatus the coupling condenser is connected in a different manner from that shown in Fig. 151-c (see Sec. 177), and in that case the coupling is loosened by a decrease of capacity in the coupling condenser.

The reaction of either circuit on the other affects, not only the value of the currents in the coils, as would be expected, but has an important influence on the frequency to which the circuits respond most vigorously. This is explained in the following:

120. Double Hump Resonance Curve.—It may be shown (Secs. 16 to 18 of Circular 74 of the Bureau of Standards) that the reactance of either of the circuits, primary or secondary, is zero; that is, the impedance is a minimum for two separate frequencies f' and f'' , which are different from the natural frequencies f_1 and f_2 , for which the primary and secondary circuits are in resonance when taken alone. With loose coupling f' and f'' differ little from f_1 and f_2 . With closer coupling, however, the differences becomes very appreciable. If f' be used to denote the lower of these two frequencies, then it may be shown that f' is always still lower than the lower of the two natural frequencies f_1 and f_2 , while the higher frequency f'' is always higher than the higher of the two natural frequencies. Increasing the closeness of the coupling has always the effect of spreading f' and f'' further apart. Furthermore, the difference between f'' and the higher of the two natural frequencies is always greater than the corresponding difference between f' and the lower of the natural frequencies.

These conclusions may be tested by means of a wavemeter. As has been already pointed out (Sec. 112), the current induced in a wavemeter circuit is a maximum when the wavemeter is tuned to the frequency of the exciting current. Suppose the wavemeter to be very loosely coupled to either the primary circuit or the secondary. Let the frequency of the current in the primary be varied by small steps and adjust the setting of the wavemeter for each frequency until the indicator shows a maximum current in the wavemeter circuit. If the settings of the wavemeter condenser and the corresponding deflections of the indicating instrument are plotted, a resonance curve is obtained which will show two humps or peaks corresponding to the frequencies f' and f'' . The positions of

the two humps will be found to be different for a second resonance curve, taken with a different coupling between the primary and the secondary. The coupling between the wavemeter circuit and the circuit which is exciting it must be made as loose as practicable in order that the wavemeter circuit may not react appreciably on the other circuits and thus change their currents.

A more direct method of showing the two frequencies is furnished by simply inserting a hot-wire ammeter or thermocouple in the circuit to be examined and noting the changes in its readings as the frequency is continuously varied.

In the case of the usual coupled radio circuits the two circuits, primary and secondary, are adjusted independently to the same natural frequency; that is, f_1 is made equal to f_2 . When the coupling is made loose both f' and f'' approach the same value, f'' from above and f' from below, and at very loose coupling $f' = f'' = f_1 = f_2$.

It might be supposed that in the special case where $f_1 = f_2$ the currents in the circuits would be a maximum for a single frequency only, namely, at the value of f to which they are both tuned. Nevertheless, both experiment and theory show that each circuit, even in this case, offers a minimum impedance at two different frequencies, just as is found for the more general case. The two frequencies f' and f'' lie on either side of the value f , though not at equal intervals from the latter, the difference $f'' - f$ being always greater than $f - f'$.

When $f_1 = f_2$ the effect of the coupling on the values of f' and f'' is shown by the simple relations.

$$f' = \frac{f}{\sqrt{1+k}}, \quad f'' = \frac{f}{\sqrt{1-k}}$$

If the coupling is made more and more loose, the two frequencies f' and f'' approach one another, and the two humps of the resonance curves finally merge and become indistinguishable from a single hump. (See also Sec. 165.)

In the absence of a secondary current there is no reaction on the primary, which is no longer a coupled circuit, and will necessarily be in resonance at a single frequency only (f by hypothesis). The same remarks apply to the secondary when the primary circuit is broken.

The further treatment of coupled circuits naturally follows two different lines, according to whether the primary is excited by a sine wave of a definite frequency (producing oscillations), or whether the primary circuit is given a single impulse and then allowed to oscillate freely. (See Sec. 115, p. 251.)

121. Forced Oscillations.—Forced oscillations of frequency f_0 will be caused when a sine-wave emf. of frequency f_0 is applied to the primary of two coupled circuits. When the emf. is initially applied to the primary, the currents in the primary and in the secondary are at first very complicated, and consist of free oscillations of the two resonance frequencies of the circuits as coupled (f' and f'' of the preceding section), superposed upon forced oscillations of the impressed frequency f_0 . The free oscillations quickly die away, and there remain sine-wave currents of frequency f_0 in both the primary and secondary.

High-Frequency Transformer.—It can be shown that to obtain the maximum current in the secondary circuit a certain value of the coupling of the coils is necessary. If the coupling be made either closer or looser than this value the secondary current falls off in value. In general, the proper coupling for maximum secondary current will depend upon the resistances of the primary and secondary and their reactances, and can be determined better by actual experiment than by calculation. For one important case, however, the values of the coupling and the maximum secondary current can be expressed very simply.

If the primary and secondary circuits are separately tuned to the frequency of the applied alternating emf. E , the maximum

possible secondary current has the value $I_2 = \frac{E}{2\sqrt{R_1 R_2}}$ where R_1

and R_2 are the primary and secondary resistances. The value of the mutual inductance (coupling) which gives the maximum secondary current may be calculated from the relation $2\pi f M = \sqrt{R_1 R_2}$. The primary current under these circumstances as-

sumes the value $I_1 = \frac{E}{2R_1}$, which is one-half the resonance value of the primary current when the secondary is absent.

These relations and the dependence of the secondary current on the coupling are illustrated in Fig. 152, which shows the changes of the secondary current as the mutual inductance between the coils is varied. The resistances $R_1=2.0$ and $R_2=12.5$

ohms are assumed, and the secondary current is plotted in terms of its maximum value, which is taken as 1. The abscissas taken are not the mutual inductance itself but $2\pi fM$, so that the curve is applicable to different frequencies, assuming, of course, that in every case the two circuits are tuned to the frequency in question. Maximum secondary current is, in this example, obtained for $2\pi fM = \sqrt{2.0 \times 12.5} = 5$. Supposing, for instance, that

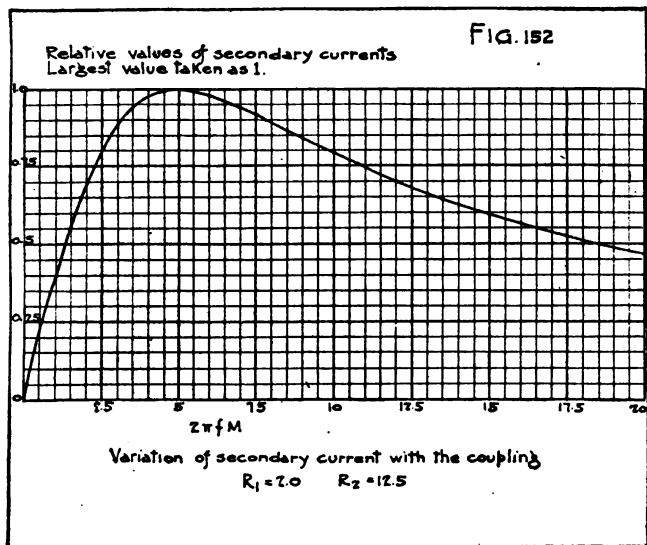

the frequency is 100,000, the coils must be so placed that their mutual inductance is $\frac{5}{2\pi \times 100,000}$, or 7.96 microhenries.

Current and Voltage Ratios.—The current ratio (secondary to primary) in the high-frequency transformer, when adjusted to give maximum current, has been shown to be $\sqrt{\frac{R_1}{R_2}}$, so that, in general, it may be increased by decreasing the secondary resistance or by increasing the primary resistance.

The voltage ratio is in general more complicated. If the two currents are tuned to one another and to the impressed fre-

quency, the voltage ratio (secondary to primary) approaches the value $\sqrt{\frac{C_1}{C_2}}$ as the resistances in the circuits are made smaller.

If the circuits are not tuned to the same frequency, but are closely coupled, the voltage ratio approaches the ratio of the number of turns on the two coils (when the resistance may be neglected), which is the case of the usual alternating-current transformer.

Inductive coupling of transmitting sets is discussed in Section 161, page 370, and types of transformers for high frequencies are described. Transformers used for radio frequencies generally have air cores, that is, no iron is used. In the case of the small radio-frequency transformers used in electron tube amplifiers (see Section 196, page 481) an iron core is sometimes used, very thin laminations being employed. Devices of transformer type, such as the Alexanderson magnetic amplifier (see Section 173, page 399) are used for controlling or modifying radio-frequency currents.

122. Free Oscillations of Coupled Circuits with Small Damping.—Suppose the condenser in the primary circuit is given a charge, and the primary circuit is closed directly or through a spark gap. If the secondary circuit is open, the primary will oscillate freely, the frequency of the current being given by the

equation $f_1 = \frac{1}{2\pi\sqrt{L_1 C_1}}$, the damping of the oscillations being determined by the ratio $\frac{R_1}{2\pi f L_1}$ as treated in Section 116, page 257.

As soon as the secondary is closed, the matter is complicated by the reaction of each circuit upon the other. An emf. is induced in the secondary by the changes of the primary current, and thereby a forced oscillation is started in the secondary. The secondary condenser is charged by this current and starts a free oscillation, whose period will depend on the constants of the secondary circuit. This latter wave will induce a forced oscillation in the primary, and similarly the oscillation which was forced in the secondary by the primary, will react on the primary, modifying the original oscillation in the primary which produced it. The oscillations in the primary will then further react on the secondary, and so on.

Naturally, the result will be very complicated, but it is evident that each circuit is the seat of two waves, one free and the other forced by the other circuit. Each of the waves which we have designated as free is, however, not entirely so, since it forces an oscillation of its own frequency in the other circuit, and has to supply the energy for this induced wave. This has the effect of modifying the frequencies of these waves from the natural values f_1 and f_2 already treated. Of the two waves in the primary, the free wave has (with loose coupling) the greater amplitude, and the same is true of the secondary except that here the amplitudes of the waves are more nearly equal. With close coupling, the forced wave in the primary becomes stronger, owing to the increased amplitude of the secondary free wave. Finally, with very close coupling, those waves predominate the frequency of which is f' . The frequency f'' of the other waves lies so far above the natural frequency of either circuit that only feeble oscillations of this frequency are present.

In general, therefore, the oscillations in both the primary and secondary circuits are compounded of two damped oscillations of different frequencies. It is of interest to study a little more closely the nature of the complex oscillations resulting from the superposition in a single circuit of the two oscillations of different frequencies.

Damping Curves of Coupled Circuits.—Fig. 153 shows two sine waves A and B of equal amplitudes but of different frequencies. Curve C is obtained by taking the algebraic sum of the ordinates of A and B . It is seen to be a curve the oscillations of which alternately increase and die away. The frequency of these fluctuations is equal to the difference of the frequencies of the components A and B . The curve C passes through its zero values at nearly regular intervals of time, the length of the intervals usually being intermediate to the intervals between successive zero values for curve A and the intervals between successive zero values for curve B . In addition, however, curve C passes through zero at one extra point in each cycle of curve C , the intervals between this extra point and adjacent zero values being about one-half of the regular interval. This extra zero value occurs at the mid-point of the cycle of curve C , where curve A and curve B pass through zero

at the same point, which is in the vicinity in which the amplitude of the oscillations of curve *C* is smallest. In Fig. 153 curve *C* has ten zero values in a cycle, including the extra zero value at the mid-point of the cycle. It is also noticeable that the loops of the curve *C* are only approximately of sine shape.

An exactly analogous case is furnished by the resultant sound wave coming from two tuning forks which are vibrating with somewhat different frequencies. The sound which is heard alternately increases and decreases in loudness, giving the phenomenon of "beats." The number of beats per second is equal to the difference in frequencies of the two forks. Thus, if two forks have frequencies of 259 and 255 vibrations per second, they combine to give a sound which beats four times per second.

Beat phenomena in the reception of undamped waves are discussed in Section 205, p. 501.

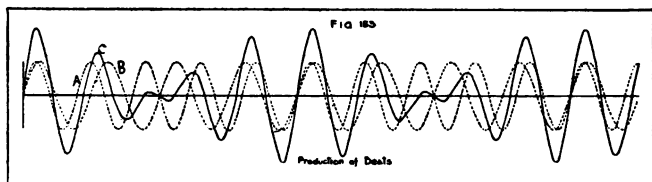

Free oscillations in coupled circuits are damped, so that in addition to the alternate waxing and waning of the resultant oscillation, the energy of the oscillation as a whole dies away according to the laws already treated in Section 116. Fig. 154 shows the nature of the damped oscillations in the primary and secondary circuits. The primary decrement is assumed to be 0.1 and that of the secondary 0.05. The two coexistent frequencies are supposed to have the ratio of 4 to 5. The curve of oscillations is in each case drawn as a full line. The dotted curves show the beating effect described above, while the dashed curves give an indication of the damping effect. It is noticeable that the primary current is passing through its maximum values at the moments when the secondary current is zero, and vice versa. Further, when the primary is passing through a period of intense oscillation, the secondary oscillations are small, etc.

Another important conclusion which can be drawn from Fig. 154 is that the energy of the coupled system is transmitted alternately from the primary to the secondary, and back again from the secondary to the primary. Thus, at certain moments the

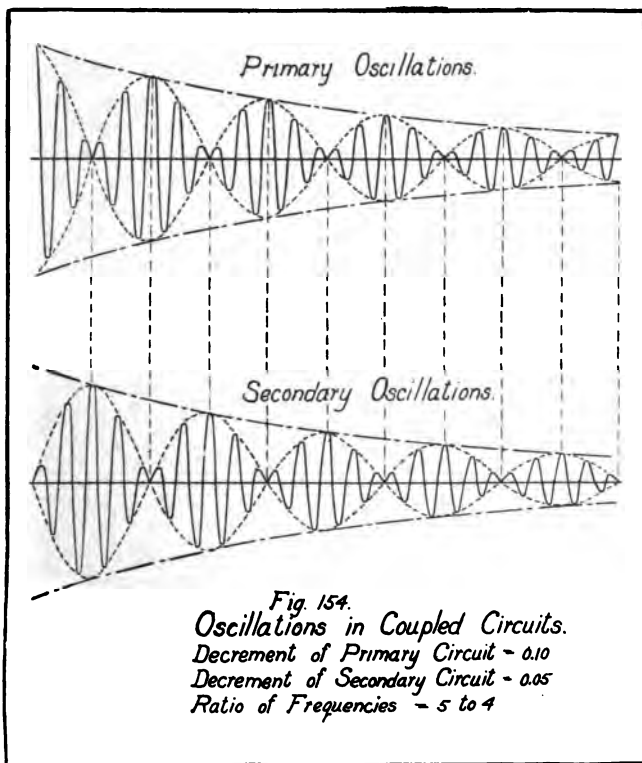

energy is entirely in the primary, at others entirely in the secondary, and at other instants partly in the primary and partly in the secondary. This transfer of energy, first in one direction and then in the other, shows that the primary and secondary play alternately the rôle of driving circuit.

From the standpoint of radiation of energy, it is desirable to hinder the return of energy to the primary, after it has once been given to the secondary. Since the closed primary circuit is of such a nature as to radiate very little energy (see Sec. 136), no useful purpose is served by the transfer of energy back to the primary, and some of the energy thus handed back is necessarily lost in heating in the primary. Further, the radiation of the energy of the secondary in waves of two different frequencies is undesirable. The receiving circuit can be tuned to give a maximum of current for either one of the incoming wave frequencies, but not for both at the same time. The partition of the radiated energy of the secondary in waves of two frequencies is therefore wasteful, since only that wave to which the receiving circuit is tuned is effective, while practically none of the energy of the other wave is usefully employed, and it may cause interference with other stations.

For a further discussion of oscillations in coupled circuits, the reader may refer to Bureau of Standards Circular 74, and to a book by G. W. Pierce, "Electric Oscillations and Electric Waves."

123. Impulse Excitation. Quenched Gap.—If by some means or other the energy of the primary circuit can be transferred to the secondary and then all connection between the circuits can be removed before any energy can be handed back to the primary, we may avoid the disadvantages just mentioned. In this case, the secondary will oscillate simply in its own natural frequency, and the loss of energy in the primary can be restricted to the short interval during which the primary is acting. By properly choosing the resistance of the secondary, the damping of the radiated wave may be kept small, and since only a single frequency is radiated, the advantages of close tuning of the receiving circuit can be realized. Such a method of excitation is known as "impulse excitation," and is analogous to the mechanical case where a body is struck a single sharp blow, and thereafter executes vibrations, the period of which depends entirely on the inertia and elasticity constants of the body itself, and not at all on the nature of the body from which the impulse has emanated.

One means of obtaining an impulse excitation of the secondary is to insert so much resistance in the primary that its current falls away aperiodically (see Sec. 116, p. 257). This has however, the disadvantage that considerable energy is lost in the primary due to the heating of the rather large resistance of the primary by the initially rather large primary current.

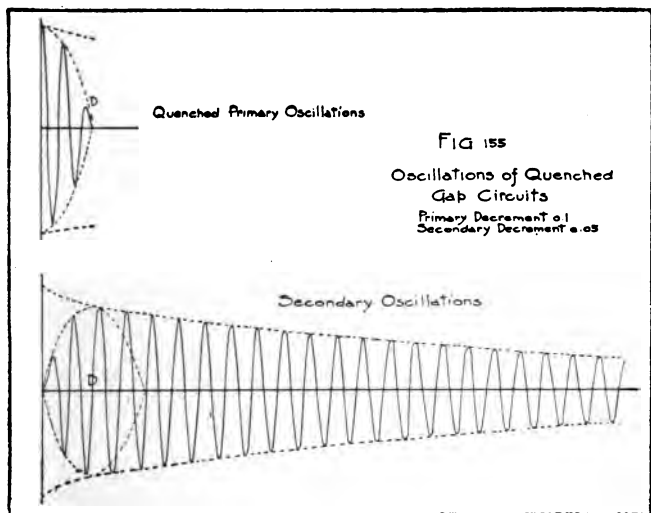

A more satisfactory arrangement is the "quenched gap." By dividing the spark gap in the primary into a number of short gaps in series, the cooling effect of the relatively large amount of metal is available for carrying away the heat of the spark discharge. This is found to be sufficient, in the case of a properly designed quenched gap, to prevent the reestablishment of a spark discharge after the first passage of the primary oscillations through their condition of maximum amplitude to zero, as at point *D*, Fig. 154. The secondary, at this moment, is the seat of the whole of the energy of the system and thereafter oscillates at the single frequency natural to it. The damping of the primary does not have to be made excessive, and the

energy lost in the primary is restricted to the heating during the short interval before the quenching of the primary oscillations.

Fig. 155 shows the form of the oscillations in the two circuits for this case. The curves are the same as in Fig. 154 up to point *D*, after which the secondary curve is a simple feebly damped oscillation. The construction and operation of the quenched gap are treated further in Chapter 5. Section 156.

CHAPTER 4.

ELECTROMAGNETIC WAVES

A. Wave Motion.

124. **Three Ways of Transmitting Energy.**—All of the ways of signaling between distant places operate by one or by a combination of these three methods:

- (a) By a push or pull on something connecting the places.
- (b) By projectiles.
- (c) By wave motion.

Thus think of all the ways in which you can arouse a dog asleep at the other side of a room. You can prod him with a long stick (method *a*). You can throw something at him. If you hit him, it is a case of method *b*; if you miss him, the noise made when the missile hits the wall or floor may wake him, in which case we have a combination of methods *b* and *c*. You can whistle or call, using sound waves (method *c*). Any way that you can think of is an example of one of these three methods.

All these three methods are important in many different kinds of physical phenomena. In the study of radio communication, wave motion, the third method, is of particular importance.

125. **Properties of Wave Motion.**—Everyone is familiar with the to-and-fro motion of water at sea, which we call waves. When a stone is thrown into a quiet pond, ripples, or little waves, are produced, which spread out until they meet the shore, or die away. A moving boat creates a particular kind of wave. Waves can be produced by rocking a boat. Ocean waves may be 40 feet in height, while a ripple may be scarcely perceptible.

If a rope supported at one end is given an impulse at the free end, each point of the rope will have a to-and-fro motion and the rope has a wave motion.

Many of the most familiar phenomena of everyday life are caused by wave motion. Sound is transmitted by waves in the

air. Light and heat are transmitted by exceedingly short waves. Our ears and eyes are detectors for particular kinds of waves. Earthquake disturbances are transmitted by waves in the earth. Air is the *medium* through which sound waves are transmitted.

When wave motion exists in a medium, each particle of the medium executes a series of to-and-fro motions, which are repeated at regular intervals. If a particle at a given point is executing a certain series of motions, then at a later instant a particle farther along in the direction in which the wave is traveling will execute the same series of motions. The number of times in a second that the same series of motions is repeated by a given particle is the *frequency* of the wave motion. Frequency is usually represented by the symbol f .

The instant after a stone is dropped into a pond, waves are formed in the immediate vicinity. (See the frontispiece.) These waves possess energy and are capable of doing work. A minute or two after the stone has been dropped the surface of the water at the spot where it was dropped will be calm again, but there will be waves at a considerable distance also possessing energy. Energy has been transmitted over this distance by means of wave motion.

Every wave has a length. In the case of water waves the wave length is usually determined as the distance between the crests of two successive waves, and the wave length of any kind of wave can be determined in the same way. The alternate crests and troughs, though invisible in many types of waves, are present in all. If we use the term *phase* to mean the position at any time of a point on the wave outline, we can say in general that the wave length is the distance between two successive points in the same phase. It is common practice to use the symbol λ (pronounced lambda) to represent wave length, usually expressed in meters.

Waves of all kinds travel with a definite velocity. When a stone is dropped into a pool, a certain time elapses before the resultant wave reaches the shore. The distance traveled by the wave in one second is its velocity. If a fixed point is watched on the surface of a pool over which waves are moving, it is seen that a crest appears at that point a definite number of times every second; this number is the frequency f . If we

multiply f , the number of waves per second, by λ , the length of each wave, we obtain the distance which the wave travels in one second, which is the velocity c .¹ In symbols, $c = \lambda f$.

Different kinds of waves have frequencies which vary greatly. Large ocean waves may have a frequency of only about two per minute, and be a half mile in length. The waves of yellow light have a frequency of six hundred million million per second, and a wave length of only one twenty-thousandth of a centimeter.

The velocity of different kinds of waves varies greatly. Waves in water do not all have the same velocity. The long ocean wave just mentioned would have a velocity of over a mile per minute. Small ripples may have a velocity of from 10 to 100 centimeters per second. Sound waves travel in air with a velocity of about 330 meters per second, or about 1083 feet per second. The velocity of light waves in space is 300,000,000 meters per second, or about 186,300 miles per second.

It has been demonstrated in many ways that radio waves are transmitted with the same velocity as light waves and the waves which constitute heat radiation, and that the three are the same kind of waves, differing in frequency. Electric waves, including radio waves, light waves, and radiated heat waves, are all referred to by the general term "electromagnetic waves." The alternating electric currents used for commercial lighting have a frequency of 60 per second and may produce electromagnetic waves of that frequency. The electromagnetic waves used for radio communication have frequencies from about 10,000 to 3,000,000 per second. Heat waves are electromagnetic waves having frequencies from about 5 million million to 200 million million per second. The electromagnetic waves which the eye perceives as light have frequencies from about 400 million million to 1000 million million per second.

In the case of water waves the more the surface of the water is displaced by the waves from its position of rest the greater is the amount of energy which is being passed along. The amount of energy transmitted by water waves depends upon the

¹ *Example.*—What is the wave length of waves having a frequency of 100,000 cycles per second which travel with a velocity of 300,000,000 meters per second?

$$\lambda = \frac{c}{f} = \frac{300,000,000}{100,000} = 3000 \text{ meters.}$$

height of the crests and the depth of the troughs. This is true of all kinds of waves.

The greatest displacement from the position of rest that any point undergoes is called the *amplitude* of the wave. In speaking of water waves, we usually call the vertical distance between the crest and the trough the height of the wave, and this is twice the amplitude. In the case of sound waves, the distance through which each particle of air moves is very small.

In general, we say that the energy in wave motion depends on the amplitude. The amount of energy in wave motion depends on the work which has to be done to produce the displacement. This is, in general, equal to the product of the resisting force and the distance moved. In the case of electromagnetic waves, including the waves used in radio communication, the resisting force is proportional to the distance moved. Hence the work done and the energy transmitted is proportional to the *square* of the amplitude of the wave.

Waves have many different kinds of shapes or forms. In the case of water waves, everyone is familiar with the large variety of wave forms produced by different conditions. A simple wave form is the sine wave shown in Fig. 71, page 117. A simple sound, such as that produced by a tuning fork, may produce an air wave having the simple sine wave form. Other sounds such as the notes emitted by musical instruments, and speech, produce air waves having much more complex wave forms. The wave forms used in radio communication may assume a wide variety of forms. (See Secs. 156, 172, 205, 206, pp. 360, 396, 501, 507.)

Every wave has the properties which have been mentioned—wave length, frequency, velocity, amplitude, and wave form. In the case of waves which are always transmitted with the same velocity, such as electromagnetic waves, the wave length, frequency, and velocity have the relation $c=\lambda f$, so that they are not independent properties.

The kind of waves which will be produced by rocking a boat depends on the size, shape, and weight of the boat and how fast it is rocked. If a small boat is rocked rapidly, we get short waves. If a large boat is rocked slowly, we get long waves. Energy is required to rock the boat, and the boat is the device for radiating this energy as waves. In radio communi-

cation the antenna is the device for radiating the electric energy as waves. Long antennas are used in radiating long waves. The antenna is discussed in detail later.

The short waves produced by rocking a small boat die out in a short distance. Longer waves produced by the motion of a large boat travel farther. Ocean waves may be half a mile in length, and travel hundreds of miles. In radio communication it is also found that long waves travel farthest.

When a train of waves due to a disturbance in a medium is transmitted through that medium, the waves are said to be "radiated" through the medium, and the source of the disturbance is said to "radiate" the waves. Thus an antenna "radiates" electromagnetic waves.

Much information concerning wave motion of interest to the student of radio communication is contained in the following books: J. A. Fleming, *Waves and Ripples in Water, Air, and Aether*; J. A. Fleming, *The Wonders of Wireless Telegraphy*; R. C. Maclaurin, *Light*; D. C. Miller, *The Science of Musical Sounds*.

126. Wave Trains, Continuous and Discontinuous.—If a stone is dropped into a quiet pool of water, a "train" of waves is started which soon passes out from the starting point in all directions, leaving the surface behind it undisturbed. If a second stone is dropped just at the moment that the surface at the starting point has completed one up-and-down excursion, another wave train will start in phase with the first, and the two will form one train. If the process is repeated once after each complete vibration of the surface at the starting point, continuous waves are produced. Similarly, if we hold a vibrating body so that it touches the surface, continuous waves are produced. By interrupting the vibrations of the body we can produce interrupted or discontinuous trains of waves. Continuous waves are produced by an organ pipe when the key is held down. Discontinuous, "damped," waves are produced by a piano when a key is struck.

Examples of these two kinds of wave trains are met with often. Thus the sound from a musical instrument where the strings are set in vibration by picking (as with a mandolin) is transmitted in discontinuous trains, while that from an instrument whose strings are bowed (as a violin) is transmitted by

more nearly continuous waves. Similarly, in radio we have to do with both kinds, continuous waves being furnished by high-frequency alternators, the Poulsen arc, and the oscillating electron tube, while discontinuous trains are given by condenser discharges in spark circuits. In these latter the amplitude of the waves diminishes steadily in each wave train; these are called "damped" waves. Such waves are discussed in Section 115.

B. Propagation of Waves.

127. **Wave Propagated by Elastic Properties of Medium.**²—In the case of ripples on the surface of water it is plain to the eye that the waves are transmitted by the passing on of the up-and-down motion of the surface at the source. This is possible because at the surface of the water the particles of the water are held together by forces which resist their displacement. When one particle is displaced its neighbors are dragged with it to some extent. In technical terms the medium of transmission is said to have "elastic" properties and the forces brought into play are said to be elastic forces. The velocity of the waves (ripples) depends on the nature and amount of these elastic forces.

In the case of sound waves in air we do not ordinarily see the vibrations of the particles of the air. The vibrations are quite small and the waves travel so fast that only under quite unusual conditions can they be made visible. But the mechanism by which the energy is transmitted is found to be of the same kind as in the case of water ripples. By the delicate elastic connections between neighboring portions of the air a vibration at one point is passed on to another. Sound waves are of another type than water waves only because the structure of air is different from that of water. Hence the elastic reaction to displacement is different in the two media. This is the sole cause of the differences between any two types of waves.

² For further explanation of the radiation of electric waves, see J. H. Dellinger, Bureau of Standards Scientific Paper No. 354; W. H. Eccles, *Wireless Telegraphy and Telephony*; J. A. Fleming, *Principles of Electric Wave Telegraphy*; G. W. Pierce, *Electric Oscillations and Electric Waves*; S. G. Starling, *Electricity and Magnetism*, pp. 428-429; L. B. Turner, *Wireless Telegraphy and Telephony*.

128. **Properties of Electromagnetic Waves.**—In the case of electromagnetic waves, often called “electric waves,” the displacements produced are of the kind already considered in the section on capacity (Sec. 29). The elastic reactions set up by such displacement currents can be found by the same laws which determine the electric and magnetic forces due to any current. It is beyond the scope of this book to show the nature of these electrical elastic forces. It will be sufficient, however, to state that they are such as to produce waves in which (in free space)—

(a) The displacement (and the electric field intensity) are at right angles to the direction of motion of the wave train.

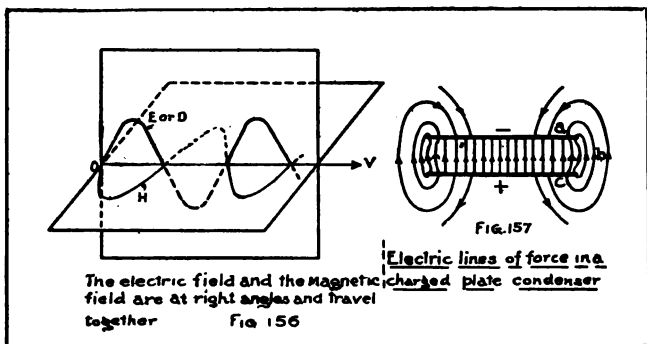

(b) The magnetic field intensity resulting from the displacement current is at right angles to the displacement and to the direction of the wave train.

(c) The variations in the displacement (or the electric field intensity) and the magnetic field intensity are in phase.

(d) The velocity of the waves is 300,000,000 meters per second, the same as the velocity of light (about 186,300 miles per second).

These relations are shown in Fig. 156, where the curve marked E or D shows the variations in the electric field intensity or displacement, and that marked H the variations in the magnetic field intensity, the wave moving in the direction shown by V .

129. Modification of Waves in Free Space Near the Earth.—Such waves if started at a point in free space travel in all directions with the same velocity. They may be modified in various ways as they proceed. Thus, if they pass into a region of different dielectric constant, they are in general changed slightly in direction and partly reflected. Their energy is also absorbed to a greater or less extent in their passage through any medium. This absorption is greater for short than for long waves. In a perfect conductor no waves could be transmitted, since in such a medium there is no elastic opposition to the displacement of electricity. A perfectly conducting sheet would reflect all of the wave energy falling on it. However, a conductor parallel to the direction of motion of a wave acts as a guide to the wave, through the action of currents induced in it by the varying magnetic field of the wave. It takes less energy from the waves, the better conductor it is. In the use of electric waves in radio communication all of these modifications occur and serve to explain many of the irregularities of received signals. We can think of the space through which radio signals are sent as being bounded below by a sheet of varying conductivity (the earth's surface) and above—at a distance of from 30 to 50 miles—by another conducting region. This upper region, where the air is much rarefied, is a fairly good conductor, owing to its ionization by radiations from the sun. The region in between these conducting layers is usually a good dielectric. Thus, this region acts more or less as a speaking tube does for sound waves, though its action is much more complicated. The electromagnetic waves are set up near the earth's surface. They are partly transmitted as guided wave trains along the earth's surface, modified by refractions and absorption at its irregularities; another part, however, goes off as space waves, which by reflections at the upper and lower layers of the conducting boundaries may recombine with the guided wave in such a way as either to add or subtract their effects, depending on circumstances. In the daytime the upper conducting boundary will be less definitely marked than at night, on account of partial ionization of the air by the sun's radiations. Hence, there will be less reflection of the space wave in the daytime, and consequently the guided wave will not be assisted materially by any reflected or refracted part of the space wave. In the night,

however, when the upper boundary is more sharply defined, there is more reflection of the space wave, and in general signals received at night are stronger than in daytime. Night signals are, however, more variable in intensity, particularly for short waves. This is especially true during the time when the sunset line is passing between two communicating stations. This is in general what we should expect, as the upper boundary would be quite variable under such circumstances. Clouds and other meteorological conditions would cause great variations in the sharpness of this boundary surface, and this may explain the rapid fluctuations in the strength of received signals often observed.

From all these considerations it can be seen that the conditions under which received signals will be most uniform in intensity are:

- (a) Transmission using long waves.
- (b) Transmission by daylight.
- (c) Transmission over short distances.
- (d) Transmission over uniform conducting surface of sea water.

It is only under these conditions that the performance of different transmitting stations can be fairly compared.

130. *Difficulties in Transmission.*—There are three principal sources encountered in practice which make it difficult to receive readable radio signals: (1) Interference from transmitting stations whose signals it is not desired to receive, (2) strays or static, and (3) the "fading" of the strength of the received signal.

Interference from other transmitting stations can to a large extent be eliminated by selection of frequency (wave length), particularly by the use of transmitting apparatus which will radiate only a single wave length or a narrow band of wave lengths. Laws have been enacted which are designed to minimize interference from other stations. (See Appendix 6.) Interference from transmitting stations using even the same wave length as the station which it is desired to receive can also be reduced by directional reception and to some extent by directional transmission, which are discussed later.

Strays are electrical disturbances giving rise to irregular interfering noises heard in the telephone receivers. They are

also called "static," "atmospherics," "X's," and other names. Investigations have shown that there are many different causes for these stray waves, but have by no means completely explained their sources. In any particular case the possibility of getting a readable signal depends on the ratio of the strength of the signal to the strength of the static at that time. Experienced operators have stated that it is possible to copy messages when the strays were four times as strong as the signals, but much difficulty is often experienced when the strays are much weaker than this. The most common type of strays produces a grinding noise in the telephones; this type causes the most serious trouble. Another type, which produces a hissing noise, is usually associated with snow or rain. Near-by lightning produces a sharp snap. Another type consists of crashes similar to but stronger than the grinding noises first mentioned. By "stray elimination" is meant methods for increasing the ratio of signal strength to stray strength.

Strays are usually much more serious in the summer than in the winter, and more serious in tropical latitudes than in more temperate latitudes. Radio communication in the Tropics presents many special difficult problems.

Strays are the most serious limitation on radio communication. Transmitting stations of high power can be built, but if the strays are strong at a given time at the receiving station satisfactory communication can not be maintained, at least not with the ordinary types of receiving equipment. A great deal of careful investigation has been done to reduce the effects of strays.

The use in particular ways of the three-electrode electron tube (see Chap. 6) has resulted in considerably reducing the effects of strays as compared with the results obtained with earlier forms of receiving equipment.³ The use of sharply tuned receiving equipment and the use of a musical note in the transmitted signal will usually somewhat reduce the effect of strays.

If the ordinary elevated type of antenna is used alone, a method for reducing strays which has given fairly satisfactory results has been the use of a receiving circuit having a primary circuit containing considerable inductance and having the

³ The use of the beat method of reception, with continuous waves, is one of the most important ways of reducing strays. See Section 205, page 506.

circuit containing the telephone receivers tuned to the audio frequency and loaded with considerable inductance.

The most satisfactory results in stray elimination have been obtained by the use of various kinds of directional receiving antennas—that is, antennas which receive most strongly signals which are transmitted from a particular direction. Such antennas are discussed later in this chapter and include not only particular forms of the ordinary elevated antenna but also the coil antenna and the ground antenna. The best results have been obtained by a combination of coil antennas and ground antennas.⁴ (See Secs. 150–152.)

“Fading” or “swinging” is a rapid variation of the strength of signals received from a given transmitting station, the same circuit adjustments being used at the transmitting and receiving stations. Fading is not usually observed at short distances from a transmitting station, but usually only at distances from the transmitting station which are at least some 10 or 20 per cent of the normal transmitting range of the station. Fading is observed particularly on short wave lengths, especially under 400 meters, and is therefore most important in amateur communication and in communication with airplanes and other special military applications. A certain transmitting station will be received with normal intensity for a few minutes; then for a minute or two the signals will become much louder; and then rapidly become much fainter and may become so weak as to be unreadable for a short time. Fading is usually observed particularly at night and usually only in transmission over land. Fading variations may be very rapid, with a period of about one second, or very slow, with a period of one hour or more. Transmitting stations located on the seacoast seem to fade more than inland stations. The principal method of avoiding transmission difficulties caused by bad fading is to increase considerably the wave length of the transmitting station, when this is possible. Fluctuations of the received signal resembling fading may sometimes be due to variations in the wave length or intensity of the transmitted wave, caused, for instance, by

⁴ Information regarding stray elimination is given in the following papers in the Proceedings of the Institute of Radio Engineers: A. H. Taylor, vol. 7, p. 337, August, 1919; A. H. Taylor, vol. 7, p. 559, December, 1919; A. H. Taylor, vol. 8, p. 171, June, 1920; R. A. Weagant, vol. 7, p. 207, June, 1919; G. W. Pickard, vol. 8, p. 358, October, 1920; L. W. Austin, vol. 9, p. 41, February, 1921.

the position of the transmitting antenna being changed by wind. If the fluctuations are due to wave length variations and are not too rapid, it is possible to vary the tuning adjustments of the receiving set to follow the wave length variations.⁵

C. Theory of Production and Reception of Electromagnetic Waves.

To produce a train of waves of any kind a vibrating body is necessary. The vibrations of this body have next to be communicated to a continuous medium, after which the elastic properties of the medium take care of the transmission of the waves. In the case of electromagnetic waves the vibrating body is an oscillating electric charge in a circuit (the sending antenna circuit), while the means by which these oscillations are communicated to free space can best be described in terms of the motion of the lines of force which, when at rest, are used to picture the field about electric charges as in Fig. 53.

These lines are to be looked upon as lines along which there is a displacement of electricity against the elastic force of the medium. Thus they can not exist in conductors (in which no such elastic forces exist). Under the action of the elastic forces the displaced electricity is continually urged to return to its position of rest. In other words, there is a tension along the lines of force. In addition there must be a pressure at right angles to the lines of force, otherwise those lines would always be straight and parallel under the action of the tensions. These pressures can be thought of as arising from the repulsion between the displaced charges of the same sign in neighboring lines.

Every alternating current has associated with it a magnetic field which can be considered to be the sum of two components having entirely different characteristics called, respectively, the "induction field" and the "radiation field."

The induction field is the only one of importance in the operation of the apparatus ordinarily used with alternating currents of commercial frequencies, such as 60 cycles. The alternating

⁵ For further information regarding fading, see S. Kruse, Q. S. T., vol. 4, p. 5, November, 1920, and vol. 4, p. 13, December, 1920; Dellinger and Whittemore, Journal Washington Academy Sciences, vol. 11, pp. 245-259, June 4, 1921.

currents by which the ordinary transformer operates (see Secs. 45 and 58) are due to the induction field. The cross talk often noticed between adjacent telephone lines is caused by the induction field. The action of the induction field on near-by circuits is often spoken of as "transformer action." If two coils are placed near together, interruptions in an alternating current passing through one coil will be reproduced in the other by the action of the induction field. The intensity of the induction field, due to a current in such a closed coil, decreases rapidly with the distance from the coil and is inversely proportional to the cube of the distance from the coil. Signals can be transmitted by the induction field, using alternating currents having frequencies from about 300 to 3000 cycles; this is called "induction signaling." One of the applications of induction signaling has been to transmit signals from a submerged cable to a ship almost directly over the cable to aid the ship in finding its course. The induction field due to the ordinary type of elevated antenna is inversely proportional to the square of the distance from the antenna. The induction field is not important in the usual applications of radio communication.

The radiation field is transmitted by wave motion. The intensity of the radiation field falls off with the distance from a transmitting station, but is inversely proportional to the distance, instead of being inversely proportional to the square or the cube of the distance. The induction field due to a current in a coil at a distance of 10 miles from the coil is only one one-thousandth of the strength of the induction field at a distance of 1 mile from the coil. The radiation field due to a current in a coil at a distance of 10 miles from the coil is one-tenth of the strength of the radiation field at a distance of 1 mile from the coil. For communication over any considerable distance, it is therefore necessary to make use of the radiation field.

For the ordinary type of elevated antenna, the intensity of the radiation field is greater than that of the induction field at distances from the transmitting station exceeding the wave length divided by 6.28.

The strength of the radiation field at a given point due to an alternating current in the ordinary type of elevated transmitting antenna is directly proportional to the frequency. When the coil antenna is used for transmitting, the strength of the radiated field is proportional to the square of the frequency.

(See Sec. 134.) It is therefore necessary to use high frequencies to get a radiation field sufficiently strong to allow successful communication. With the ordinary type of elevated antenna, the radiation field at a given point due to an alternating current having a frequency of 1,500,000 cycles (wave length=200 meters) would be 25,000 times as strong as the radiation field due to an alternating current having a frequency of 60 cycles.

The above statements are for radiation in free space. In actual communication part of the energy of the radiated field is, however, absorbed in the surface of the earth or in the surface of the ocean as the wave travels. This absorption effect is greater for high frequencies (see Secs. 129 and 134). It need not ordinarily be taken into account in short-distance work, but at distances greater than about 100 kilometers it becomes important. For this reason it is not possible to indefinitely increase the strength of the radiated field at a given distance by increasing the frequency. (See Secs. 134-136.)

The statement is sometimes made that a circuit carrying an alternating current of low frequency, such as 60 cycles, does not radiate. This is not really true; radiation does occur, but is of very feeble intensity.

Another statement sometimes made is that an "open" circuit can radiate, while a "closed" circuit can not; this is not true. All circuits are closed. Radiation from coils is described later in this chapter.

For further information regarding radiation the reader may refer to Bureau of Standards Scientific Paper No. 354.

131. Magnetic Field Produced by Moving Lines of Electric Displacement.—Consider what happens to the lines of force when a condenser is discharged. Before the discharge begins, the field is as shown in Fig. 157. Now, suppose a wire to replace the line *abc*, thus discharging the condenser. The displacements previously existing along *abc* vanish, or, in other words, the line shrinks to nothing when the tension is relieved. But this, at the same time, does away with the sidewise pressure on the neighboring lines, which, since the pressure from the lines outside of them still remains, move inward toward the wire under the action of this unbalanced pressure. Their ends slide along the plates of the condenser during this motion, and when they come to the wire the displacements along their length

vanish. This process continues until all the lines have vanished and the condenser is discharged.

Now, while this is happening to the electric lines of force in the field, a current has been flowing in the condenser plates and the wire *abc*; also, the magnetic lines of force which always accompany any current have sprung into existence and continue to exist as long as the current flows. In the space between the condenser plates these magnetic lines of force will be directed up from the plane of the paper at right angles, both to the electric lines of force and to the direction of their motion. These two facts can be described in terms of the motion of the lines by saying that the motion of the ends of the electric lines along a conductor causes a current to flow in it, while the motion of the electric lines at right angles to their own length produces magnetic lines of force in the other direction, which is perpendicular to the direction of motion. If the motion of the electric line is parallel to its length, there will be no magnetic field produced. From this point of view, what takes place in the medium is the cause of what takes place in conductors. The energy in the former (in the case we are considering) appears in the latter as heat.

132. Mechanism of Radiation from a Simple Oscillator.—Now consider what takes place when the discharge is oscillatory instead of in one direction. To fix our ideas, let us take the case of the simple Hertzian oscillator, the electrostatic field of which, before the gap becomes conducting, is shown in Fig. 158-i.⁶ (The field to the left is shown by dotted lines, in order to be able to keep track of each line clearly in its motion as shown in the following figures.) When a spark passes and the gap becomes conducting, the straight electric line of force represented by the straight line connecting the gap terminals vanishes and those from each side begin to move up under the unbalanced sidewise pressure as before. Here, however, when the ends of the first curved line to the right of the gap in Fig. 158-i reach the gap, we must suppose that it has sufficient momentum so that the ends cross and the middle portion travels across the gap. After two lines have done this, the state of things is as represented in Fig. 158-ii. There will soon come a different state of things, however, owing to the shape of the lines. When the

⁶ See S. G. Starling, *Electricity and Magnetism for Advanced Students*, 2d ed. (1916), pp. 423-429, from which Fig. 158 is taken.

ends get to the gap before the middle portion, as shown in Fig. 158-iii, they will cross as before, and soon thereafter we will have the loop formed as in Fig. 158-iv. Now, at some time as the ends continue to go up, this loop will break, forming two parts m and n , as shown in Fig. 158-v. This is because at that moment the angle of intersection becomes so acute that each part of the line will be moving parallel to its length, in which case neither half will have any magnetic field and, consequently, no momentum to carry them by each other. The process goes on as shown in Figs. 158-vi, 158-vii, and 158-viii, the last of which shows the state of things when one half oscillation has been completed and the charges on the oscillator have been reversed in sign. A cylindrical sheet of lines of force has then been detached from the oscillator and is traveling outward. At this

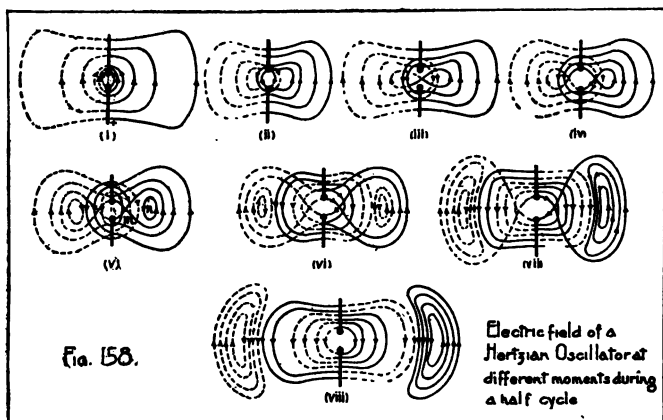

Fig. 158.

Electric field of a
Hertzian Oscillator at
different moments during
a half cycle

moment those lines left attached to the oscillator have been stretched as far as their momentum can carry them, and they begin to contract again and repeat the process, provided the gap is still conducting. In the next half wave length another cylindrical sheet of lines of force will be snapped off, so to speak, and the process will continue until the energy lost as heat in the oscillator has exhausted the supply of lines which remain attached to it. These cylindrical sheets, as they spread out, become more and more nearly plane, the plane being perpendicular to the motion away from the oscillator. During the

process shown in Figs. 158-ii to 158-vii—that is, while the current in the oscillator is flowing upward—the motion of the electric lines of force generate magnetic lines (not shown), which form circles around the oscillator running into the paper to the right and coming out on the left. These magnetic lines vanish at any point, when the electric lines of the attached field come to rest as in Figs. 158-i or 158-viii, but continue with the moving electric lines of the radiated cylindrical sheet. When the cylindrical

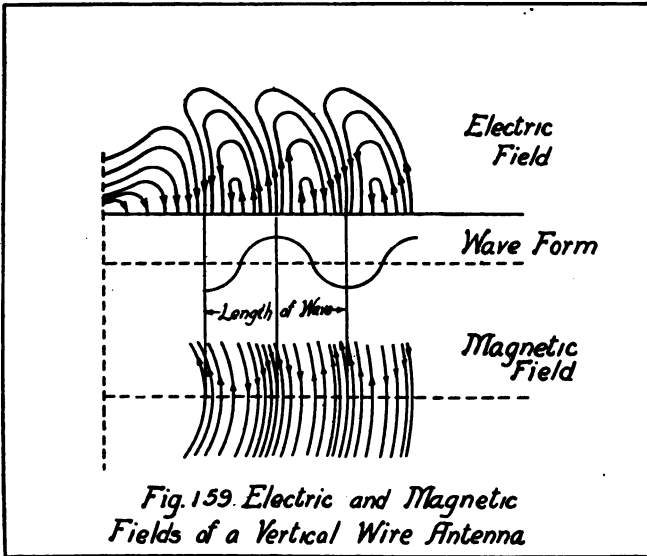

Fig. 159. Electric and Magnetic Fields of a Vertical Wire Antenna

sheets have moved so far that they can be considered practically as planes, then the magnetic lines also lie in these planes, but perpendicular to the electric lines and to the direction of motion.

In the case of a simple vertical antenna, the mechanism of radiation is quite similar. In this case, however, since the lower end of the antenna is earthed, only the upper halves of the waves shown in Figs. 158-i to 158-viii are produced, so that the field looks like that shown in Fig. 159, where the electric lines are shown in elevation and the magnetic lines in plan, while in between is shown the wave form common to both. At

any one point in space the lines approach and separate like a bellows. When the wave has progressed so far that the lines can be regarded as sections of planes, the state of things will be as shown in Fig. 160 for the electric lines, while the same figure will also represent the magnetic lines if rotated through 90° about the line ox . Where the surface over which the waves travel is not a perfect conductor, the ends of the lines will be as shown in Fig. 161.

The same method of picturing the process of wave production applies to other forms of radiating systems of either the open antenna or the closed coil type, (See Sec. 151, p. 330.) In all

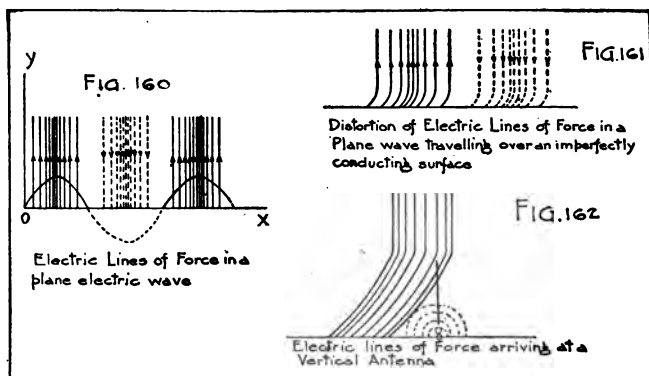

kinds, loops are formed and detached in the same general way. In some of them the distribution of the lines of force is such as to favor the production of more such loops than in others; this means that such an antenna will be a better radiator than the others.

133. Action in Receiving.—The mechanism of the reception of waves by an antenna can be followed through in terms of the lines of force in an analogous manner. Thus, suppose the antenna to be located with respect to the incoming wave train as shown in Fig. 162. Then the upper ends of the lines as they arrive travel down the antenna, as shown in the dotted lines, and give rise to moving charges of electricity in the antenna, or the receiving action can be thought of in another way. As the advancing waves sweep across the receiving antenna the electric

field intensity along the antenna alternates in value. This is equivalent to an alternating voltage between the top of the antenna and the ground. A still different way of looking at the receiving action depends upon the principle that an emf. is induced in a conductor whenever there is relative motion between the conductor and a magnetic field. The moving wave has a magnetic field which sweeps past the antenna, and thus there is relative motion between the antenna and this magnetic field, which results in an emf. in the antenna. This emf. is what causes the received current in the antenna.

The reception of electromagnetic waves in a closed coil used in place of an antenna can be explained by the same principles. The explanation is somewhat difficult because of the differences of phase between those currents in different parts of the coil. For such antennas it is more convenient to think of the current as produced by the changing magnetic flux through the coil, due to the alternations of the magnetic field associated with the wave. Either way of looking at it leads to the same result. (See Section 151, page 330.)

D. Transmission Formulas.

134. **Statement of Formulas.**—When the general ideas of wave production and reception discussed above are put into exact mathematical language, it is possible to deduce certain practically useful formulas connecting the currents in the sending and receiving antennas, their heights, resistances, and distance apart. While it is beyond the scope of this book to derive them, they are given without proof to aid the student in gaining an idea of the magnitude of the effects to be expected at various distances and with different types of antennas. In the formulas which follow h stands for the height of an antenna or coil, I for current, λ for wave length, d for the distance apart of the two antennas or coil aeri-als, while the subscripts s and r refer to the sending and receiving ends, respectively. R stands for the resistance of the receiving circuit. All lengths are supposed to be in meters.

If the waves are sent out by a simple flat top antenna and received on a similar one, we have

$$I_r = \frac{188h_s h_r I_s}{R\lambda d} \quad (83)$$

If the waves are sent out by a simple antenna and received on a coil, we have

$$I_r = \frac{1184 h_s h_r l_r N_r I_s}{R \lambda^2 d} \quad (84)$$

where l_r is the length of the receiving coil and N_r the number of turns of wire with which it is wound.

If the waves are sent out by a coil and received on a simple antenna, we have

$$I_r = \frac{1184 h_s l_s h_r N_s I_s}{R \lambda^2 d} \quad (85)$$

where l_s is the length of the sending coil and N_s the number of turns of wire with which it is wound.

If the waves are sent out by a coil and received on a similar one, we have

$$I_r = \frac{7450 h_s l_s h_r l_r N_s N_r I_s}{R \lambda^3 d} \quad (86)$$

The above formulas are for transmission through free space, and do not take into consideration the diminution of the wave intensity by absorption of the radiated energy in the surface over which the wave travels. The absorption effect can be taken into account by multiplying the values of received current obtained from any of the above formulas by the factor

$$e^{-0.000047 \frac{d}{\sqrt{\lambda}}}$$

where d is the distance in meters, λ is in meters, and e is equal to 2.718. This correction factor as computed from this formula is intended to apply to daytime transmission over sea water. It can be neglected in short-distance work. Thus, at wave lengths of about 1000 meters this correction can be neglected at distances less than 100 miles, but at considerable distances becomes much more important. For transmission over land the value of this correction factor will be modified according to the nature of the land. If it is night in all or part of the territory over which the waves travel the received current is somewhat greater.

These formulas were developed by J. H. Dellinger and first published in Radio Transmission Formulas, a confidential paper of July, 1917. They are given in Bureau of Standards

Scientific Paper No. 354, Principles of Radio Transmission and Reception with Antenna and Coil Aerials, by J. H. Dellinger, June 18, 1919.

The formula (83) given above for transmission from a simple flat-top antenna to a similar antenna is the theoretical formula for a Hertzian oscillator having its length the actual height, h_s , of the antenna above ground. For an antenna over a good conducting surface there is probably a considerable image effect, tending to increase the value of h_s , but there are other factors which tend to reduce it; hence the formula is a practical approximation to ordinary conditions. Austin's formula, which has been much used, assumes the existence of a perfectly conducting surface but defines h_s not as the actual height, but as the "effective height" of the antenna. If the ground is assumed to be a perfect conductor, the antenna and its image can be considered to form a hypothetical oscillator of a length equal to twice the height of the antenna to its center of capacity. It is found in many cases that the effective height is about half the total height, and seldom approaches the full value. The effective height depends on how good a conducting surface there is under the antenna, and is greater for a good conducting surface. Dr. Austin has also published formulas for the other three cases, in which coil antennas are used, which yield values of received current twice the values which are obtained from equations (83), (84), (85), (86), given above. Dr. Austin has published his formulas, together with experimentally observed values, in the "Proceedings of the Institute of Radio Engineers," vol. 8, pages 416-420, October, 1920. Transmission formulas are also discussed by G. W. O. Howe, Radio Review, vol. 1, page 598, September, 1920.

135. **Examples of Use.**—To illustrate the use of the formulas suppose it is desired to know how much current must be put into a plain antenna 20 meters high sending a 300-meter wave, in order that the current in a similar antenna 50 km. away shall be detectable easily with a crystal detector (that is, shall be about 10^{-10} amp.), the resistance of the receiving antenna being 10 ohms.

Solving the first equation for I_s , we have:

$$I_s = \frac{R\lambda d I_r}{188 h_s h_r} = \frac{10 \times 300 \times 50,000 \times 10^{-10}}{188 \times 20 \times 20} = \frac{1}{5} \text{ amp. approximately.}$$

As another example, suppose that the receiving antenna, in the first example, is replaced by a square coil of 2 ohms resistance, having sides 2 meters long and wound with 10 turns of wire. If the sending current is $\frac{1}{2}$ amp. as before, what will be the current in the receiving coil? Using the second formula

$$I_r = \frac{1184 h_s h_r l_r N_r I_s}{R \lambda^3 d} = \frac{1184 \times 20 \times 2 \times 2 \times 10 \times \frac{1}{2}}{2 \times 300 \times 300 \times 50,000} = \frac{2.1}{10^6} \text{ amperes.}$$

For a current of this size it would be best to use a simple electron tube receiver instead of a crystal detector.

As a third example, suppose the sending aerial to consist of a single square turn of wire 10 meters on a side, in which the current is $\frac{1}{2}$ amp. at $\lambda=1000$ meters. With how many turns should a square coil 2 meters on a side and having a resistance of 5 ohms be wound to receive at a distance of 50 km., if an electron tube which can detect a current of $\frac{1}{10^6}$ ampere is used? Solving the fourth equation for N_r we have

$$N_r = \frac{R \lambda^3 d I_r}{7450 h_s l_s h_r l_r N_s I_s} = \frac{5 \times 10^9 \times 5 \times 10^4 \times 1/10^6}{7450 \times 10 \times 10 \times 2 \times 2 \times 1 \times \frac{1}{2}} = 4 \text{ turns (about).}$$

136. General Deductions.—From the formulas certain general conclusions can be drawn. Thus since λ appears in the denominator, it follows that, for given heights of antenna, sending current, receiver resistance, and distance apart, there will be more current in the receiver, the shorter the wave length used. On the other hand, there is more absorption of short waves than long ones, as was stated when we were considering the modifications that free waves undergo (Sec. 129). This effect is taken account of in the correction factor to be used for large distances. In this factor, λ enters in such a way as to make the received current less when the wave length is short than when it is long. Hence, in general, we conclude that to get the greatest possible received current, we should use short waves for short distances and long waves for long distances.

It may be seen from the formulas that, for simple antennas, the received current (for a given wave length, sending current, receiver resistance, and distance apart) is greater, the greater the heights of the antennas. In the case of coil aeriels under the same conditions, the received current is greater the larger the areas and the number of turns of the coils. For the dimensions actually used, antennas are much more effective radiators and

receivers than closed coils. In order to secure the same radiation or received current with a closed coil as with an antenna, other conditions being the same, its dimensions must be made nearly as great as the antenna height. However, it is often pos-

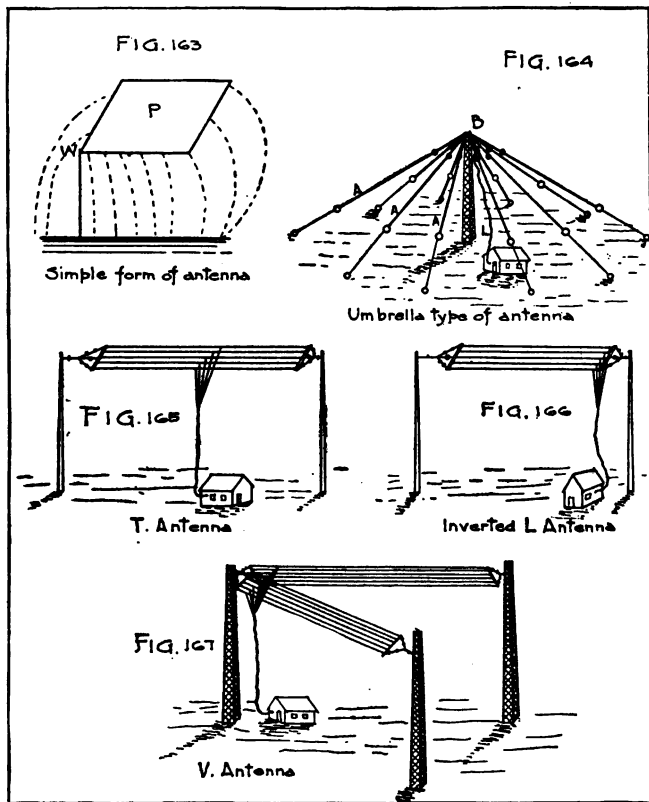

possible to put more current into a transmitting coil than into the corresponding antenna, and also the resistance of a receiving coil is usually smaller than that of the corresponding receiving antenna. Hence the coil can be a smaller structure than the antenna.

The coil has some other advantages. For a given power input in the transmitter, the coil aerial is not at quite such a disadvantage with the ordinary antenna as the formulas show, because a larger fraction of the radiation is sent out in the direction desired. As a receiver, the coil has the very great advantage that the direction of the waves it receives can be determined. These points are discussed further in Sections 151-152.

E. Devices for Radiating and Receiving Waves.

137. Description of the Antenna.—In radio communication it is necessary to have a device to radiate electric waves and a device to receive electric waves. Devices used for this purpose are called antennas. Often the same antenna is used both to radiate and receive.

There are two general classes of antennas, those which act primarily as electrical condensers and those which act primarily as electrical inductances. The first type is usually referred to simply as an "antenna." The second type is usually referred to as a "coil antenna," "coil aerial," "loop," or, when used for a particular purpose, as a "direction finder." We will first consider antennas of the first type. Coil antennas are discussed in Sections 151-152.

A simple antenna of the condenser type would consist simply of two parallel metal plates, separated, as shown in Fig. 157. The energy radiated or absorbed by an antenna of the condenser type depends on its capacity, and to form an antenna of large capacity two metal plates would have to be so large as to be very expensive and cumbersome.

Instead of using two parallel metal plates, it would be possible to form a condenser consisting of one metal plate suspended over and parallel to the ground, providing the surface of the ground is appreciably conducting. Such an antenna is shown in Fig. 163. The plate *P* is supported above the earth and insulated from it, except for the connection through the wire *W*, called the "lead-in wire," or "lead-in." The plate and the conducting surface of the earth form the two plates of a condenser, the air between them furnishing the dielectric. The apparatus used for receiving is introduced into the lead-in, between the plate and the ground. When radio waves reach

an antenna they set up an alternating emf. between the wires and the ground. When an alternating emf. is introduced into the wire, charging currents flow into and out of P and the earth, the dielectric being strained first in one direction and then in the other. As has been explained in the previous chapter, these strains are equivalent to displacement currents of electricity through the dielectric, which serves to complete the circuit. A region in which the dielectric is undergoing alternating strains is the starting point of electric waves. The larger the plate and the higher it is raised from the earth, the greater the amount of space in which this strained condition exists, and the more powerful the waves which are radiated.

However, in order to construct with a given amount of metal an antenna having the greatest possible capacity, the metal should not be used in the form of a single plate. A much more efficient form consists of a number of parallel wires. The antennas found in practice usually consist of arrangements of wires. A single vertical wire is, for its size, the best radiator, but it has to be made extremely long in order to get sufficient capacity for long wave or long distance work (see Sec. 141). Antennas consisting of horizontal or inclined wires are, however, also very satisfactory. Any arrangement of wires which will constitute one plate of a condenser may be used, although some arrangements will radiate and receive much better than others.

An investigation has been made at the Bureau of Standards of the use for reception of a condenser antenna consisting of two parallel pieces of metal screen a few feet apart.¹ The amount of energy absorbed by such an antenna is necessarily small, but for some purposes, when used with sensitive receiving equipment, it has advantages.

A satisfactory antenna can also be constructed, using a suitable arrangement of wires for the upper plate of the condenser and using for the lower plate a number of parallel wires elevated a few feet from the earth and insulated from the earth. No connection is then made to the earth itself. The wires forming the lower plate of the condenser are then called a "counterpoise antenna" or simply a "counterpoise."

¹ See *Wireless Age*, 8, pp. 11-14, April, 1921.

In reception electric waves reaching an antenna set up an alternating emf. between the wires forming the upper plate of the condenser, and the ground or other lower plate of the condenser. The longer and higher the wires forming the antenna the greater the emf. produced. As a result of this emf. an alternating current will flow in the antenna wires. The energy of the current is absorbed from the passing wave, just as some of the energy of a water wave is used up in causing vibrations in a slender reed which stands in its way.

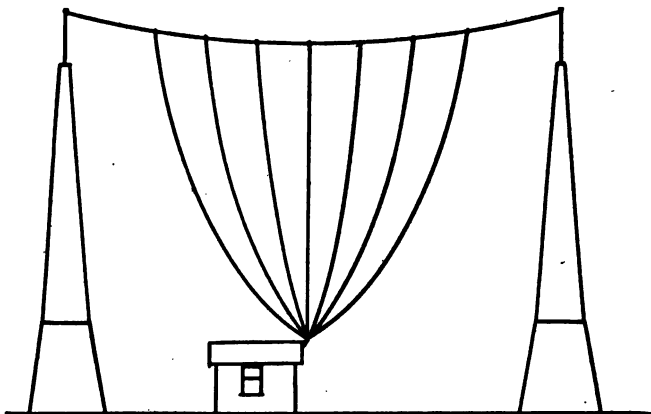

FIG.167-A
"FAN" OR "HARP" ANTENNA.

138. **Different Types.**—An antenna consisting of horizontal parallel wires supported between two masts and insulated therefrom is common. This is a standard form for ship stations. If the lead-in wires are attached at the end of the horizontal wires (Fig. 166) the antenna is said to be of the inverted *L* type. If the lead-in wires are attached at the center of the horizontal wires, the antenna is said to be of the *T* type. Both of these types are found at many land stations, including amateur stations. The wires are kept apart by "spreaders," which may be of wood. These two types are often referred to as "flat-top" antennas.

The *V* type of antenna (Fig. 167) consists of two sets of horizontal or slightly inclined wires supported by three masts, so

that the horizontal portions form an angle. The V type is used to some extent in military work, but is not much used elsewhere.

The "fan" or "harp" antenna consists of a number of wires radiating upwards from a common terminal to various points on a supporting wire to which they are connected. (Fig. 167-A.) The supporting wire is insulated at each end from the tower or other support. Practical advantages of the fan type are that there are only two insulators, so that leakage is small, and that the mechanical strain to be carried by the supports is comparatively small.

The "cage" type of antenna is used to a considerable extent, particularly on ships. (Fig. 167-B.) A number of parallel wires, often six or eight, are supported from a single point and are kept apart by star-shaped separators which may be of wood, or by hoops. One advantage of the cage type for military purposes is that if one or two wires are shot away the antenna can still be used.

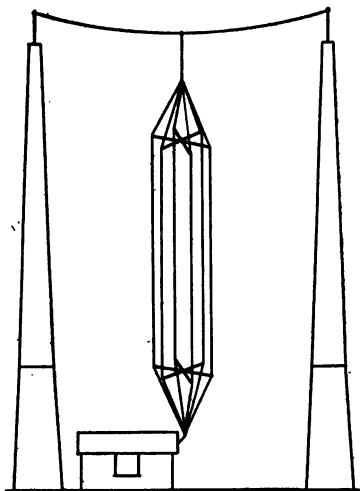

FIG. 167-B
"CAGE" ANTENNA.

For transmission over short distances a very simple antenna may be used, such as, for example, a single wire supported between two stakes at a height of only a few feet from the ground. In some cases a long insulated wire may be laid upon the ground or in a shallow trench, forming a "ground antenna." (See Sec. 150a.) For receiving stations equipped with good electron tube amplifiers (see Chapter 6) very simple antennas may be employed, even for long-distance work, such as a single suspended wire, a ground antenna, or a coil antenna. (See Sec. 151.)

The umbrella type of antenna, Fig. 164, consists of a number of wires which diverge from the top of a mast, and are attached

to anchors in the ground through insulators, *A*, as shown in the figure. Lead-in wires *L* are brought down from the junction of the wires *B* to the apparatus.

For high-power stations a type called the "multiple-tuned antenna" is sometimes used; this is described briefly in Section 143.

139. Current and Voltage Distribution in an Antenna.—When an emf. is introduced into an antenna, a charging current flows in the wires as was described in the ideal case of Fig. 163. If we attempt to form a picture of this process in the wire antenna, we must remember that every inch of the wire forms a little condenser, with the earth acting as the other plate. The antenna is said to have a distributed capacity.

As the electricity flows from the bottom of the antenna, some of it accumulates on each portion *A* of the wire, causing a displacement current through the dielectric to earth, as shown in

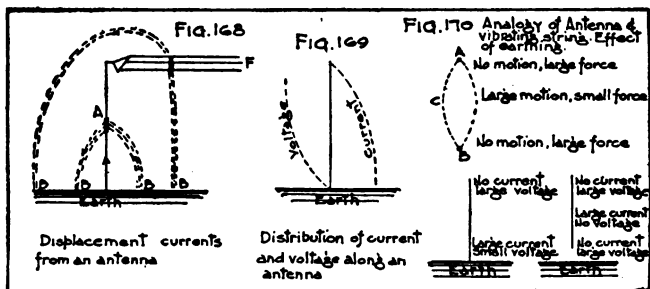

AB (Fig. 168). The current in the wire accordingly diminishes as the free end *F* of the antenna is approached, and becomes zero at that end. The current is evidently different at different parts of the antenna, being zero at the free end and a maximum where the antenna is connected to the ground (Fig. 169). This is in marked contrast to the case of a direct current, which always has the same value at every point of the circuit. The difference here is brought about by the very high frequency of the currents.

The voltage of the antenna, on the contrary, is zero at the grounded end and has a maximum value at the free end. In fact, the latter is the point where the most intense sparks can be drawn off; therefore the insulation of the antenna from

near-by objects and the earth must be particularly good at this point. (In Fig. 169 the voltage and current are supposed to be measured by the horizontal distance from the solid vertical line.)

A large capacity to earth, concentrated at any point of the antenna, causes a large change in the current at that part of the antenna. If this bunched capacity is located at the top of the antenna, such as is the case with a flat-topped antenna of long wires, with only a few vertical lead-in wires, the average current in the flat top portion will be large, and it increases slightly in strength as the charges pass down through the lead-in wire (picking up the charges there), hence giving a large current through the receiving apparatus. It is a distinct advantage to have as large a part of the total capacity of the antenna as possible at the top.

The action of antennas is discussed in Bureau of Standards Circular No. 74 and in Bureau of Standards Scientific Paper No. 326, "Electrical Oscillations in Antennas and Inductance Coils," by John M. Miller.

140. Action of the Ground—Counterpoises.—The electric oscillations in an antenna may be regarded as somewhat analogous to the vibrations of a string stretched between two points *A* and *B* and plucked at the middle, *C*, in Fig. 170. The stretching forces on the string are greatest at the points *A* and *B*, while the portion *C* is under very small force. The motion of the string is most considerable at *C*, while the points *A* and *B* do not move. If we regard current as similar to motion and voltage to force, we can see (according to statement in the preceding section) that the top of the antenna resembles in its behavior the end *A* (or *B*) of the string, while the bottom of the antenna corresponds to the point *C* of the string.

The part played by the earth may now be understood. If we suppose for a moment that the antenna is disconnected from the ground and insulated, then the lower free end would become a point where the current would be zero and where the variations of voltage would be large (corresponding to point *B*, Fig. 170). The portion where the current would be a maximum would lie at some elevated point. To set a string in vibration requires the smallest force when it is plucked at the middle. Right at the ends it is almost impossible to set it in vibration. Just so the antenna, if disconnected from earth, would be almost impos-

sible to set in vibration if the emf. were applied at the bottom end. For successful working, the exciting apparatus would have to be joined to inaccessible points of the wire higher up. It is necessary, then, to make sure that the lower end of the antenna is a region where a current is large, and with a good ground this condition is satisfied.

In places where the ground has poor conductivity (dry, rocky soil, with ground water at some considerable depth) it becomes difficult to satisfy the above condition. In such cases a "counterpoise antenna" or "earth capacity" must be used. The counterpoise is another antenna of suitable type, supported a few feet above the ground, and insulated from it. The station apparatus is connected to the regular antenna and the counter-

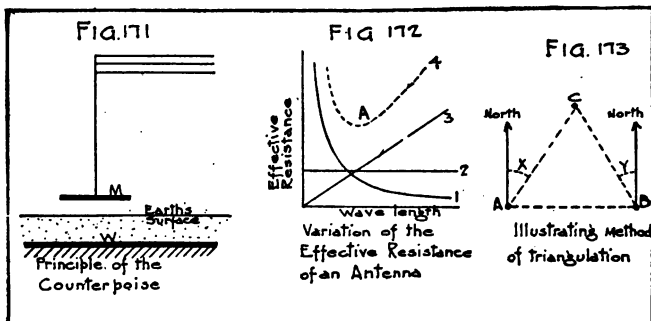

poise, instead of to the regular antenna and earth. The use of a properly designed counterpoise is often advantageous even where the earth has fairly good conductivity. As far as the antenna is concerned, the counterpoise takes the place of the ground. To some extent the action of a counterpoise can be considered as that of two condensers in series; one antenna consisting of the regular antenna and the counterpoise, and the other consisting of the counterpoise and the more moist layers of the earth (*W*, Fig. 171) deep below the surface. The counterpoise is usually simply a number of wires supported a few feet from the ground, but may be a metal screen or netting. The wires may be distributed radially from the foot of the antenna. The area covered by the counterpoise should preferably be several times as large as the area of the antenna itself, but in any event should be as large as the area of the antenna.

On aircraft, a counterpoise must necessarily be used. The counterpoise is furnished by the metal wires of the framework, the engine, stay wires, metalized wings, etc. The antenna may consist of a long wire which trails behind the plane when in flight, has a weight attached to its end, and is wound up on a reel before landing.⁸ With such an antenna the antenna is below the counterpoise, but the action is not different from the ordinary antenna and counterpoise systems. The trailing wire antenna is inconvenient in some respects. In many cases it is found more convenient on aircraft to use a coil antenna, which may be wound on the wings of a plane, or may be wound on a small frame and installed aft in the plane (see Sec. 152).

F. Antenna Characteristics.

The behavior of an antenna depends upon its capacity, inductance, and effective resistance, just as is the case with any oscillating circuit. The capacity and inductance determine the length of the radiated waves (see Sec. 116); the resistance determines the damping.

141. **Capacity.**—The energy which can be given to a condenser, when it is charged to a voltage E , is equal to one-half the capacity C , multiplied by the square of the voltage. The energy which is supplied to an antenna each second when it receives N charges per second is, therefore (as given in Sec. 34),

$$P = \frac{1}{2} CE^2 N.$$

We may, evidently, increase the supply of power to an antenna by increasing the number of charges per second, or by raising the voltage.

It is not practicable to raise the rate of charging beyond about 1,000 to 1,500 sparks per second. The voltage on the antenna can not be made greater than about 50,000 volts without loss of power through leakage and brush discharges. The only remaining factor which can be varied is C in the above formula; therefore, a high power sending antenna must have a

⁸ See J. M. Cork, Airplane Antenna Constants, Bureau of Standards Scientific Paper No. 341; 1919.

large capacity. Large capacity means many wires of great length; that is, a large and costly structure.

The capacity of a single wire parallel to the ground can be calculated approximately, as also the capacity of certain simple arrangements of parallel wires (see Circular 74, pp. 237-242). Even in the simplest cases, however, the presence of houses, trees, and other neighboring objects, and the difficulty of allowing for the lead-in wire, makes any precise calculation impossible. It should be noted, however, that the capacity of a wire is proportional to its length. The capacity of two wires near together is less than the sum of their capacities, and, in general, although each added wire adds something to the capacity, it adds much less than the capacity it would have alone in the same position. As an indication of what values of antenna capacity may be expected, the following values may be cited:

Airplane and small amateur antennas, 0.0002 to 0.0005 microfarad.

Ship antennas, 0.0007 to 0.0015 microfarad.

Large land station antennas, 0.005 to 0.015 microfarad.

That is, in spite of their size and extent, antennas do not possess greater capacity than is found in ordinary variable air condensers (see Sec. 32 and Sec. 184).

The following formula has been found to give fairly accurate values for the capacity of a flat-top antenna under conditions met in practice:

Taking C =capacity of antenna, micromicrofarads

A =Area of flat top of antenna in square meters (the triangular, or quadrilateral area, or area of other shape, inclosed by the bounding wires of the antenna)

h =average value of actual height of antenna above ground, in meters (for horizontal top, h =actual height above surface of ground)

the formula may be written

$$C=40\sqrt{A}+8.85 \frac{A}{h}$$

For a very long antenna, having a length l more than eight times the breadth of b , the above formula must be multiplied by an elongation factor

$$\left(1+0.01\frac{l}{b}\right)$$

For values of capacity computed by this formula the height is not so important as it is for values of capacity computed according to some other formulas which have been suggested. Values of capacity computed according to the formula just given have been found to agree fairly well with measurements made on actual antennas.

This formula was published by L. W. Austin, *Journal Washington Academy Sciences*, volume 9, page 393, August 19, 1919; *Proceedings Institute Radio Engineers*, volume 8, page 164, April, 1920; and has been discussed by G. W. O. Howe, *Radio Review*, volume 1, page 710, November, 1920.

142. **Inductance.**—Although principal stress has been laid upon the conception of the antenna as a condenser, the inductance which its wires necessarily possess is of equal importance in determining the wave length of the radiated waves. The antenna is, in fact, an oscillating circuit, and as such the wave length or frequency of free oscillation depends upon the product of the inductance and capacity. See formula (79), Section 116.

The inductance in general is not large—50 to 100 microhenries is a common range of values—but larger capacity is necessarily associated with larger inductance, so that high-power antennas are naturally long-wave antennas. Methods for measuring inductance and capacity of antennas are described in Section 171, page 392, and in Circular 74 of the Bureau of Standards, pages 79 to 86, and 98. The relations between the wave length of an antenna, and its capacity and inductance, are discussed in Circular 74, page 79.

143. **Resistance.**—The wires of an antenna offer resistance to the current, which is greater for the high-frequency antenna current than it would be for a steady current, on account of the skin effect (see Sec. 117). In addition to this, the radiation of energy in waves causes a further increase in the apparent resistance of the antenna. The "effective resistance of the antenna" is defined as the quotient of the power given to the antenna by the square of the antenna current. That is, if R is the effective resistance, the total power put into the antenna is RI^2 , where I is measured at the base of the antenna. The effective resistance is different for different frequencies, as is shown below.

The total power is dissipated in the following ways: (1) As heat in the antenna wires and earth connection, (2) brush discharge, (3) leakage over or through insulators, (4) heat in the dielectric surrounding the antenna, and in any condensers that are in the antenna circuit, and (5) radiated waves. Part of (5) will also be turned into useless heat by inducing eddy currents in near-by conductors, such as guy wires or metal masts. If $R'I^2$ represents all the power except that radiated, and $R''I^2$ represents the power radiated as waves, then it is evident that $R'I^2 + R''I^2 = RI^2$, or $R' + R'' = R$, the effective resistance. R'' is called the "radiation resistance." It might be defined as that resistance which, if placed at the base of the antenna, would cause as great a dissipation of energy as the energy radiated in waves. It will be different at different frequencies. It gives an idea of the radiating power of the antenna for each ampere of antenna current.

When the effective resistance of an antenna is measured at a number of frequencies and the results are plotted, a curve is obtained like curve 4, Fig. 172, page 310. The shape of the curve is explained by considering the laws according to which the different kinds of resistance in the antenna vary with the wave length. The radiation resistance decreases as the wave length increases, the relation being that the radiation resistance is inversely proportional to the square of the wave length. Such a variation is represented by curve 1, Fig. 172, page 310. The resistance of the conductors and earth connection is nearly constant with different wave lengths, curve 2. The dielectric resistance increases nearly as the wave length, curve 3. Curve 4 is the sum of curves 1, 2, 3. If the losses in the dielectric are very small, the curve does not have a minimum, as at A, but becomes horizontal at the right end. If these are negligible, the curve merely falls toward a limiting value.

To reduce the dielectric losses, no portion of the antenna should be near buildings or trees. To reduce eddy current losses, care should be taken to have the antenna a reasonable distance from guy wires, and especially large masses of metal. Guy wires may be cut up and insulated in sections. On shipboard, induced currents are produced in iron stacks and guy wires near the antenna, and in cases where the frequency of the waves agrees with the natural frequency of oscillation of

these metal objects, considerable power losses may result. These show themselves, when they are present, as humps on the experimental curve 4, Fig. 172, page 310, at the frequencies in question. Reference may also be made to Bureau of Standards Scientific Paper No. 269, "Effect of Imperfect Dielectrics in the Field of a Radiotelegraphic Antenna," by John M. Miller.

The effective resistance of an antenna is often as high as 20 to 30 ohms at the fundamental wave length. The minimum value may be 5 to 10 ohms for a land station and as low as 2 ohms for a ship station.

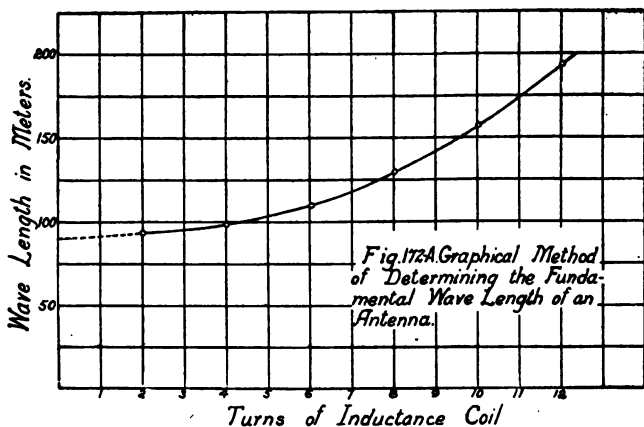

Methods for the measurement of the capacity, inductance, and resistance of an antenna are described in Section 171, page 392.

At high-power stations employing high-frequency alternators an antenna of comparatively small effective resistance has been secured by the use of a "multiple-tuned antenna." At such stations the antenna may be a mile or more in length and may constitute a considerable part of the total cost of the station equipment. The multiple-tuned antenna is a long antenna which is grounded at several points along its length through loading inductances, by means of which the individual sections are tuned to the wave length which it is desired to radiate. (See Fig. 173-A.) A high-frequency alternator or other transmitting apparatus may be inserted, as shown at A.

This is equivalent to connecting several antennas in parallel; the radiation resistance remains the same as for the antenna connected in the ordinary way, but the actual resistance of the ground connections of the whole antenna is the resistance of a single ground connection divided by the number of ground connections. The antenna at the high-frequency alternator station at New Brunswick, N. J., is about 1 mile long, and has been grounded at five intermediate equidistant points. The antenna so connected is equivalent to six independent radiators, and the total resistance of the antenna has dropped from 3.8 ohms with the ordinary system of grounding to 0.5 ohm with the multiple ground at a wave length of 13,600 meters. The ground resistance has been reduced from about 2 ohms to

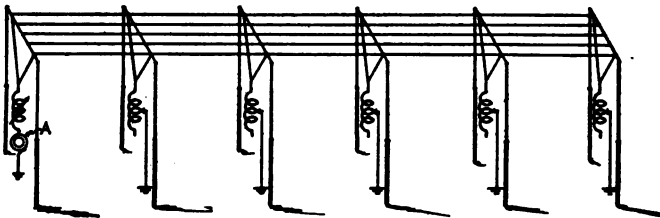

FIG.173A.MULTIPLE-TUNED ANTENNA.

0.33 ohm. Antennas of this type have so far been used only for high-power work, and a detailed description will not be given here. The multiple-tuned antenna is well adapted for use with the high-frequency alternator, because in this case the radiated wave length of a given alternator depends only on its speed and not on the antenna. The multiple-tuned antenna does not, however, seem to be so well adapted to tube and arc transmitters and not at all to spark transmitters, because in such transmitters the radiated wave length depends on the antenna. For further information the reader may consult papers by E. F. W. Alexanderson, *General Electric Review*, volume 23, page 794, and E. E. Bucher, *General Electric Review*, volume 23, page 813, October, 1920.

144. **Wave Length and its Measurement.**—The wave length of the waves emitted by an antenna, when no added inductance or capacity is inserted in the antenna circuit, is known as its "fundamental wave length." By putting inductance coils

("loading coils") in the antenna circuit, longer waves may be radiated, while on the contrary, condensers put in series with the antenna enable it to produce shorter waves than the fundamental. The use of a series condenser is avoided where possible, since it has the effect of decreasing the total capacity of the antenna circuit (Condensers in Series, Sec. 35) and thereby diminishing the amount of power which can be given to the antenna. The addition of some inductance has a beneficial effect, since the decrement of the antenna is thereby lessened and a sharper wave results. It is not advisable to load the antenna with a very great inductance, however, as it is not an efficient radiator of waves. The waves emitted are very much longer than the fundamental wave length. As a general rule small sending stations, for short ranges, work best on short waves, and long-distance stations on long waves. Long waves have the advantage for long-distance work that they are not absorbed in traveling long distances to the extent that short waves are.

The United States radio laws at present provide that every commercial radio station shall be required to designate a certain definite wave length as its normal transmitting and receiving wave length, and that this wave length must not exceed 600 meters or must be longer than 1,600 meters. Ship stations must be equipped to transmit on either 300 or 600 meters. Amateur stations must not transmit on a wave length exceeding 200 meters. It is probable that the radio laws will be revised in the immediate future. For authoritative information regarding current radio laws and regulations inquiry should be made of the Bureau of Navigation, Department of Commerce, Washington, D. C. See also Appendix 6.

Communication with ships is usually carried on with a wave length of about 600 meters. Radio compass stations on shore operate on 800 meters, and radio beacon stations on shore, which transmit to ships to enable the navigator on the ship to determine its position, usually operate on 1,000 meters. Most high-power stations, such as those for transatlantic work, operate on a wave length of at least 2,500 meters, usually considerably more. The Annapolis station, for instance, operates on about 16,900 meters and the New Brunswick station on about 13,600 meters.

Measurement of Antenna Wave Length.—For a simple vertical wire grounded antenna the fundamental wave length is slightly greater than four times the length of the wire. The constant is often used as 4.2, and applies approximately also to flat top antennas (*L* or *T* types) with vertical lead-in wire, the total length being measured from the transmitting apparatus up the lead-in wire and over to the end of the flat top. It is usually easier, and certainly more accurate, to measure the wave length radiated from an antenna directly by the use of a wavemeter (Sec. 112). The wavemeter coil needs merely to be brought somewhere near the antenna or lead-in wire and the condenser of the wavemeter adjusted to give maximum current in the wavemeter indicator. The wave length corresponding to the wavemeter setting is then the length of the waves radiated by the antenna. The "fundamental" wave length of the antenna may be determined by gradually decreasing the number of turns in the loading coil, measuring the wave length for each setting of the loading coil, and plotting a curve showing the wave length corresponding to the various numbers of turns of the loading coil, as shown in Fig. 172-A. The "fundamental" is the wave length corresponding to zero turns, and corresponds to the point where the extension of the curve cuts the wave length axis.

The amateur is required by law to transmit on a wave length not exceeding 200 meters and is interested to know the kind of antenna to use. It is impossible to give an exact rule for constructing an antenna for a particular wave length, because many local conditions peculiar to each case must receive consideration. An approximate rule which will be found convenient in constructing an antenna which is to transmit on a wave length not exceeding 200 meters is that the over-all length of the circuit from the ground connection through the entire path which the current follows to the end of the antenna must not exceed 120 feet. This distance, 120 feet, includes the distance from ground up the ground lead to the antenna switch, from the antenna switch to the oscillation transformer and back to the antenna switch, through the antenna lead-in to the antenna top, and along the antenna top to its end. This approximate rule applies to the various types of antennas ordinarily found at amateur stations, including inverted *L*, *T*, and fans. In the case of an antenna for which the lead-in is taken

off the antenna top at an intermediate point, as in a *T* antenna, the distance along the antenna top should be measured to the most distant end of the top, if the lead-in is not connected at the middle of the top. If an antenna is constructed in which the distance measured as described does not exceed 120 feet, it is probable that with suitable transmitting apparatus and no loading it will be possible to transmit on less than 200 meters, but if loading inductances are used or equivalent changes made in the transmitting apparatus the emitted wave length may, of course, considerably exceed 200 meters.

145. Harmonics of Wave Length.—A simple radio circuit has a reactance equal to zero at a single frequency, namely, the resonance frequency, and the maximum current possible with the given emf. will then flow. This result is strictly true only when the capacity and inductance are concentrated at definite points of the circuit. In an antenna, however, the inductance and capacity are distributed, and it is found that a maximum of current is obtained for a whole series of different frequencies or wave lengths.

What is called the "fundamental frequency" is the lowest frequency for which the current attains a maximum when not loaded with either capacity or inductance. Denoting this by f , there are in the same antenna other resonance frequencies $3f$, $5f$, $7f$, etc., called the "harmonic frequencies" of the antenna. With the usual methods of producing current in an antenna it radiates principally waves of its fundamental frequency alone; free oscillations of the harmonic wave lengths are almost entirely lacking. However, when emfs. having the harmonic frequencies are applied, vigorous oscillations of those frequencies may be set up. (See also Bureau of Standards Scientific Paper No. 326.)

146. Directional Effect.—It is a familiar fact that devices for transmitting or receiving wave motion of any kind, which are not symmetrical with respect to a line perpendicular to the plane in which the wave travels, will transmit and receive better in one direction than in another. Thus a resonator for receiving sound from a distance should be turned perpendicular to the direction of the source of the sound, to give the maximum response.

A single vertical wire (Fig. 173-B) forms an antenna which is entirely symmetrical for radio waves traveling horizontally, and such a wire has no directional effect. If for a given antenna fixed in a given position we plot a curve showing the strength of the received current received from transmitting stations located in different directions, we will find this curve a very useful means of describing the directional characteristics



FIG. 173-B.

SIMPLE VERTICAL WIRE
ANTENNA AND ITS DIREC-
TIONAL CHARACTERISTIC.

of the antenna. For the single vertical wire the directional characteristic is simply a circle drawn with the foot of the wire as center. The electrical and magnetic fields radiated in transmitting from a vertical wire antenna are shown in Fig. 159, page 297. Most of the other types of antennas ordinarily used have directional properties, at least to some extent. The inverted *L* antenna has a considerable directional effect. An inverted *L* antenna with a long, low top (Fig. 173-C), such as are often found at large stations, has a marked directional effect, as shown by the directional characteristic in Fig. 173-C. The length of the line drawn from the central point *A* in any direction indicates the strength of the current received from a transmitting station located in that direction. It will be noted that the inverted *L* transmits and receives best in the direction opposite to that in which the antenna top points. The multiple-tuned antenna, as shown in

Fig. 173-A, has a considerable directional effect. Ground antennas (see Sec. 150-a) have marked directional characteristics. The most important type of directional antenna is, however, the coil antenna, described in Sections 151-152. Particular kinds of directional effects can be secured by combining different kinds of directional antennas.

The directional properties are most often made use of for receiving, but are also used for transmitting.

In transmitting, a considerable part of the energy may be concentrated in a particular direction by the use of a direc-

tional antenna, and the range of a transmitting station thus increased and interference decreased. Directive transmission may also be very helpful to a ship or airplane in aiding it to determine its location.

In receiving, an antenna having a marked directional characteristic, such as a coil antenna, will receive strong signals from a particular direction, and weaker signals from other directions. This is valuable in reducing interference from stations which it is not desired to receive, since in general the interfering station is not likely to lie in the same direction as the station which it is desired to receive.

A further and very important application of antennas with directional characteristics is the possibility of triangulation. If

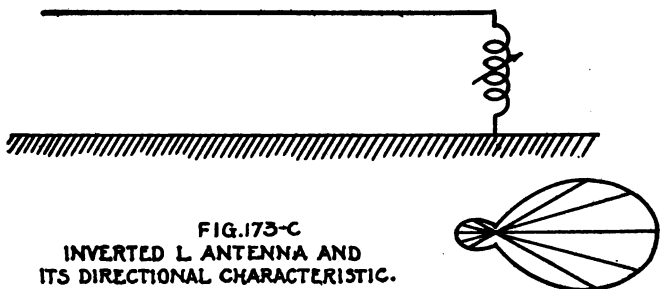

C, Fig. 173, page 310, is a transmitting station, and the waves come in to station *A* from a direction which makes an angle α with the north, while at station *B* waves from *C* arrive from the direction *BC*, which makes an angle γ with the north, then the positions of the stations *A*, *B*, *C* can be calculated, provided only that the distance *AB* and the angles α and γ are known. If *C* is an enemy station, it may be located by measurements of its direction, as observed from receiving stations *A* and *B*, whose positions are known. Or if *C* is supposed to be a lighthouse station which is radiating signals, a vessel can determine its unknown position *A*, even in a fog, by observing the direction of *C* and then after sailing a known distance *AB* making similar radio observations of the direction of *C* from its new position *B*. The positions *A* and *B* and the ship's course can be worked out. Even in clear weather it is often desirable

to have a means of checking up astronomical observations of the ship's position, since a small error of observation may have serious consequences when a vessel is near the coast. For further information regarding direction finding see Sections 151-152.

G. Antenna Construction.

147. **Towers and Supports.**—For land stations wooden masts have been much employed. For portable antennas these are made in sections, which fit together like a fishing rod. For higher-power stations latticed metal masts are common and in some cases tubular metal masts in telescoping sections. Except in special instances, guy ropes or wires are necessary, and in some cases the support is sustained entirely by these. It has been quite generally regarded as a structural advantage to allow a small freedom of movement to the mast, so that it may rock slightly in the wind. A simple one-wire antenna may be held by any support that is available. When a tree is used to support either end, a rope should run out for some distance from the tree and the wire be attached to this by an insulator, so that the antenna wire itself may not be in or near the tree. The standard flat-top ship antenna makes use of the ship's masts for supports. The antenna wires are stretched between two booms or spreaders, from which halyards run to the masts.

148. **Insulators.**—The insulation of an antenna is a matter requiring careful attention. If an insulator is defective or dirty or wet, the energy radiated from the antenna will be considerably reduced. Defects of insulators may be caused by breakage after installation or faulty manufacture, such as small cracks or other openings through which the insulator may absorb water, or nonuniformity of the material of the insulator. Dirty insulators are likely to be found near industrial plants, and on ships wet or salt-covered insulators may cause trouble. In Fig. 174 is shown an antenna of a type often found on ships and at the smaller land stations, with its insulators. Porcelain is one of the most satisfactory materials for use in constructing insulators because of the large voltages which it will stand without failure, but it is not suitable for use under severe mechanical vibration. Antenna insulators are often made of compositions, such as the material called "electrose," which is made

with a shellac binder. These insulators are made in various shapes, including rods, and usually have eyebolts or other metal pieces molded in. Insulators are also made with ribs or petticoats which may extend farther than the ribs shown in Fig. 176; the purpose of the ribs is to lengthen the leakage path which the current must follow between eyebolts and to secure

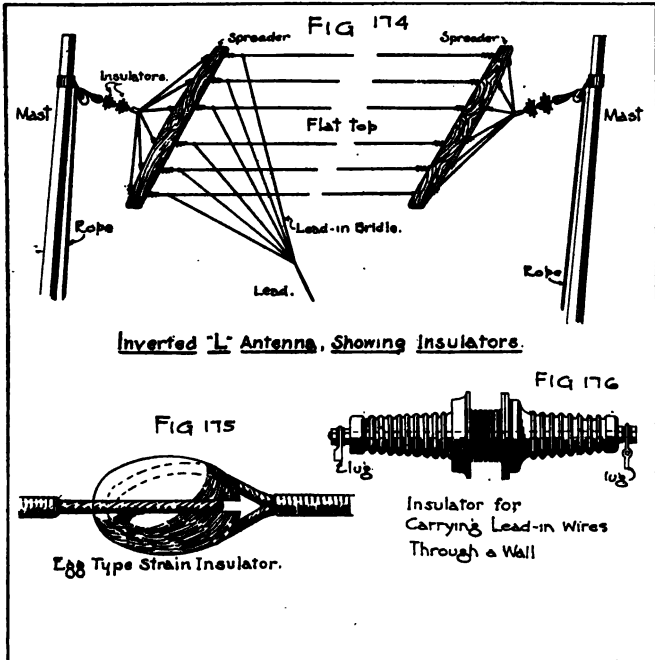

better insulation when the insulator is wet by collecting the water on the lowest points of the ribs. In the case of antennas for land stations, wire guys are interrupted by "strain" insulators to prevent the guy from having a natural wave length approximately the same as the wave length of the antenna. A form of nearly spherical porcelain insulator, so grooved as to carry the two wires firmly without their coming in contact, is

shown in Fig. 175. In the event of this insulator breaking, the wires do not part.

Where the lead-in wires from the antenna pass through the walls of the house in which the sending and receiving apparatus is installed, special care needs to be taken to ensure good insulation. A form much used for this purpose is shown in Fig. 176. In the case of some large aerials, the supporting mast itself has to be insulated from the ground at its base. The design of an insulator which combines sufficient mechanical strength with good dielectric properties is a difficult matter.

149. Antenna Switch. Conductors.—An antenna switch is a necessity in all permanent installations. This has the function of disconnecting the receiving apparatus from the antenna completely when a message is to be sent, and vice versa. The action of such a switch is made such that it is impossible for the operator to make a mistake and impress the large sending voltage upon the delicate receiving apparatus.

Every radio station should be provided with a lightning switch on the outside of the building by means of which the antenna should be grounded at all times when not in use to avoid possible damage from lightning. Information regarding the requirements made by insurance companies for lightning protection may be secured from the National Board of Fire Underwriters, New York, and from local insurance agents. See also Appendix 9, page 578.

Antenna wire.—Desirable qualities in a metal to be used for antenna wire are that it shall not be brittle, that it shall be durable when exposed to weather and other conditions met in service, that its weight shall not be excessive, that its cost shall be reasonable, and that its ohmic resistance shall be low. It is also sometimes important that a metal used for antenna wire shall possess high tensile strength; this is obviously most important for large antennas of long span.

It has been pointed out in Section 117, page 263, that at high frequencies the flow of current in a conductor takes place largely near its circumference. This results in the resistance of a wire at radio frequencies being higher than its resistance to direct current or to alternating current of low frequencies, such as 60 cycles, and is called the "skin effect." The skin effect is considerably greater for wires of iron or steel or other magnetic material. For this reason ordinary iron or steel wires are not suitable for use as antenna wire.

Hard-drawn copper wire is often used, but has the disadvantage that it is brittle and kinks easily. Tinned copper wire is sometimes used. Soft-drawn copper wire may also be used, depending on the tensile strength required for the distance to be covered. Aluminum wire is also used, and is satisfactory if careful attention is given to the connections and joints, to avoid corrosion. An important advantage of aluminum wire is that it is light. This is particularly important in large antennas, which cover long distances.

Iron or steel wire which has been heavily galvanized is also used. Since the current flows largely in the zinc coating, the resistance is much less than that of an ungalvanized steel wire. Steel wire to which a thick coating of copper has been permanently welded, is sometimes used. Information regarding the resistance of coated wires of this kind is given in Bureau of Standards Scientific Paper No. 252, "Effective Resistance and Inductance of Iron and Bimetallic Wires," by John M. Miller. The resistance losses in the coated steel wires are about the same as in solid copper wire, provided that the coated steel conductors are not too close together.

Bare, uninsulated wires are in general use. In some cases the antenna wire is covered with a thin coating of enamel, whose purpose is to eliminate corrosion of the wire by exposure to the weather, smoke, or acid or other fumes.

Solid copper or other conductor, in sizes such as No. 14, is often used. Stranded conductor, however, has advantages, including flexibility, and lower resistance at high frequencies than solid conductor, because of the skin effect. In the stranded conductor for a given weight of copper there is much more cross-sectional area available for carrying the current than there is in the solid conductor. The individual strands should, however, always be enameled in stranded wire used for radio-frequency currents, or the stranded conductor may have a higher resistance than solid conductor of the same weight.

An antenna conductor composed of seven or more strands of carefully enameled No. 22 copper wire is usually found to give good satisfaction. Antennas of unenameled solid conductor, which are very satisfactory on the day they are installed, after exposure for even a week to the weather, often show a very considerable increase of resistance. Phosphor-bronze stranded wire of seven or more strands is sometimes used, has a high

tensile strength, but is open to the objections that it is relatively very expensive, and has a comparatively high ohmic resistance. Phosphor-bronze wire corrodes easily when exposed to weather, and when corroded is very likely to have higher resistance than a solid conductor. A silicon bronze wire is now being used to some extent, which does not corrode easily, has comparatively low ohmic resistance, high tensile strength, and has been found very satisfactory. For many ordinary antennas, hard-drawn solid copper wire, carefully enameled, will be found most convenient, and will give good satisfaction.

150. **Grounds and Counterpoises.**—To obtain a good conducting ground connection is a comparatively easy matter for a ship station. In a steel ship a wire is attached to the hull of the ship and the good conductivity of the sea water assures an intimate connection with the ground. A usual method of grounding on a wooden ship propelled by steam is to connect the ground lead to the thrust box and depend on the propeller to make contact with the water. The hulls of some wooden ships are protected by being covered with copper sheathing, and a good ground connection may be made to this sheathing. In some cases a ground for a wooden ship may be made by means of a large metal plate attached to the outside of the ship, under water.

The ground connections for a land station should be designed with the idea of constructing one plate of a condenser of which the antenna is the upper plate. The area covered by the ground connections should be several times the area of the antenna, and should be laid out fairly symmetrically with respect to the antenna. The effort should be made to obtain a considerable number of points of contact with the earth, having paths of low resistance. Metal plates buried in the earth are often used. A good ground system may be constructed by burying metal plates of the same area, symmetrically arranged around the circumference of a circle having the station as the center, and connected to the station by wires suspended a short distance above the earth. A good general principle to follow is that the same current should be carried per unit area by each buried plate. If this principle is not observed, as in a ground system laid out at random consisting of a number of ground connections of different impedances located at varying distances from the station, it

may be found that the over-all resistance of the system will be considerably greater than the resistance of the best one of the ground connections used alone. A considerable number of copper wires run radially from the foot of the antenna to a distance considerably greater than the length of the antenna will make a good ground if the earth is moist. When radial wires are used it is often found advantageous to run the wires for a short distance suspended above the ground before burying them. In dry localities a ground connection is sometimes made to a well; this may be found useful for receiving, but in general is not very satisfactory. In cities a ground connection may be made to water pipes or gas pipes. Connections to steam pipes and sometimes to gas pipes may be unsatisfactory because they may make poor contact with the ground. Connections to gas pipes should always be made between the meter and the street.

Counterpoises have been briefly discussed in Section 140. The counterpoise should be designed with the idea of constructing the lower plate of a condenser of which the antenna is the upper plate, and should cover an area at least as great as that of the antenna, and preferably somewhat greater. The counterpoise may consist of an arrangement of parallel or of radial wires, supported 3 or 4 feet above the surface of the ground and insulated from the ground. Metal screen may also be used. A counterpoise should be supported at as few points as possible to keep its resistance low. To construct an antenna system of low resistance it is necessary to take all precautions to keep low the resistance of the condenser constituting the antenna. Only those insulating materials should be allowed in the field of the counterpoise which have little dielectric power loss. Wooden stakes should be kept out of the field of the counterpoise, because wood usually has a considerable power loss. Porcelain insulators are usually satisfactory. The counterpoise should be carefully insulated from any wooden stakes which support it by suitable insulators. If used for transmission with continuous waves, a counterpoise should be rigidly supported so that it will not sway with the wind in order to prevent variations in the transmitted wave length.

150a. **Ground Antennas.**—It has been found by Kiebitz and many other observers that signals can be effectively received on an antenna consisting of a single long wire on or a short

distance under the surface of the ground. This is called a ground antenna. It operates more effectively when the soil is wet rather than dry, and with an insulated rather than a bare wire. It can also be used under the surface of either fresh or salt water. In salt water it should be submerged only a short distance below the surface. The best results are usually obtained with wires well insulated with moisture-proof material.

It seems on first consideration contrary to the usual explanations of radio reception that an antenna extended in a horizontal direction and on or under the ground should be acted upon by a radio wave. The explanation is, first, the wave front of an advancing radio wave is tilted, the amount of this tilt probably being greater just at the surface of the ground than at higher points; and, second, the waves penetrate the ground to some extent, the amount of penetration depending upon the wave length and character of the ground.

The amount of power received by a ground antenna is considerably less than that received by the usual elevated antenna. It is usually necessary to use amplifiers (see chapter 6) to get satisfactory signals. The ground antenna, however, has a number of compensating advantages, so that for some kinds of work its use is desirable. It is a directional receiving device, the strongest signals being received when the wire extends along the line of direction of propagation of the waves. It is stated that the ground antenna does not exhibit the usual troubles during local thunderstorms which make an elevated antenna dangerous to the operator. The ground antenna also, as sometimes employed, has a somewhat greater ratio of signal strength to strays than the usual elevated antenna. The use of the ground antenna in combination with a coil antenna has been found to be of considerable assistance in the elimination of interference and strays, since under proper conditions this combination forms a unidirectional receiving system.

Ground antennas have been used in some experiments for transmitting, but there is apparently no advantage in their use for this purpose.

The length of the wire which should be used as the ground antenna depends on the wave length of the signals to be received. Thus for long wave lengths longer wires should be used than for short wave lengths. The length of the ground antenna

or underwater antenna which should be used for the reception of a particular wave length depends on the diameter of the conductor itself and also on the nature of the dielectric material adjacent to the conductor. That is, the best working wave length of a given wire depends on the kind of insulation used on the wire, whether the wire is in earth or in water, and if in earth whether the earth is dry or moist. It has been stated that the best working wave length of a ground antenna is inversely proportional to the capacity of the wire to ground per unit length of the wire. That is, with a given size of wire, the thicker the insulation the longer the most effective wave length, and with a given thickness of insulation, the larger the wires the shorter the most effective working wave length.

If it is desired that a wire buried in the ground should remain in effective operation for more than a few months it is usually necessary to use wire insulated with at least one-fourth inch of good live rubber. Such construction is, of course, expensive. For temporary work an insulated wire is sometimes simply laid out on the surface of the ground.

In earth of the average range of moisture content a ground antenna 75 feet long may be expected to give satisfactory reception from about 150 to 500 meters. For the reception of long waves, as 6,000 meters to 15,000 meters, it may be necessary to use a ground antenna 1,000 or 1,500 feet long. Under average conditions it will be found suitable to use stranded or solid copper conductor, about No. 14 B. & S., with good rubber insulation, buried in a shallow trench from 6 to 12 inches below the surface of the ground. Under some conditions it may be advisable to bury a wire as deep as 24 inches.

It has been found advantageous to place wires in fairly wet soil or in water, because louder signals will be usually obtained and because the best working wave length of a given wire will remain more nearly constant.

With an underwater wire the signal falls off rapidly with the depth in salt water, but in fresh water wires have been submerged as deep as 60 feet without appreciable decrease of signal.

It should be noted that a ground antenna can not be expected to give good results when used with a crystal detector alone or with a single detector tube, and that for good signals it is

usually necessary to use several stages of amplification. (See Sec. 196, p. 479.) At a small receiving station with usual equipment it will usually be found more satisfactory to use the ordinary elevated antenna with good ground connection in preference to a ground antenna.

For further information regarding ground antenna the reader should consult the following papers in the Proceedings of the Institute of Radio Engineers: A. H. Taylor, volume 7, page 337, August, 1919; A. H. Taylor, volume 7, page 559, December, 1919; A. H. Taylor, volume 8, page 171, June, 1920; R. A. Weagant, volume 7, page 207, June, 1919; L. W. Austin, volume 9, page 41, February, 1921.

H. Coil Antennas.

151. Coil Antennas—Directional Characteristics.—It has been pointed out in Section 137 that the ordinary elevated antenna acts primarily as an electrical condenser, while the coil antenna can be considered to act primarily as an electrical inductance. A coil antenna consists essentially of one or more turns of wire, forming a simple inductance coil.

In both types of antennas, an approaching radio wave induces an emf. in a wire or arrangement of wires. In the ordinary elevated antenna the induced emf. causes a current to flow in a circuit which includes a condenser consisting of the antenna and ground, or antenna and counterpoise. In the coil antenna the induced emf. causes a current to flow in a circuit connected to the detecting apparatus which is completely metallic.

It is a common experience in radio stations to be able to hear signals on a sensitive receiving set when the antenna is entirely disconnected from the set. This is largely due to the action of the wiring of the set as a coil antenna.

A common type of coil antenna consists of four turns of copper wire wound on a square wooden frame about 4 feet on a side. The amount of energy received on such a coil antenna is far less than that received on any of the ordinary elevated types of antennas as practically used.

It can not be emphasized too strongly that satisfactory results can not be expected in reception using coil antennas unless very good electron tube amplifiers are used to amplify

many times the feeble current received in the coil. Usually a six-stage amplifier (see Chapter 6) is used for satisfactory results, but even with two stages of audio-frequency amplification, some signals can be received from nearby stations.

The practical development of the coil antenna and its present widespread applications are due entirely to the development of the electron tube amplifier to a high state of perfection.

Coil antennas may be used for either transmission or reception, but their use for transmission is rather limited, while their use for reception is extensive and constantly increasing.

A coil antenna may be used with satisfactory results inside an ordinary building. With suitable amplification a comparatively small coil can be used for receiving transatlantic stations.

Coil antennas are particularly used when a compact, portable, type of antenna is desired, or when an antenna having a marked directional characteristic is desired.

The action of the coil antenna can be considered from different points of view. We can imagine two vertical wires of the same length, say 300 meters apart, supported by and insulated from any convenient supports, with their lower ends also insulated. Then any radio wave approaching the two wires will induce an emf. in each wire. If the wave approaches from a direction perpendicular to the plane of the two wires, the crest of the wave will reach each of the wires at the same instant and the two induced emf.'s will be exactly in phase. If the wave approaches from any other direction, the induced emf.'s will in general be out of phase, and for a given wave length the difference of phase will be greatest for a wave approaching in the direction of the plane of the two wires. If we assume a wave approaching from the direction of the plane of the two wires and having a wave length of 600 meters, the emf.'s induced in the two wires will be 180° out of phase, because the time required for the wave to travel the distance of 300 meters between the two wires will be one one-millionth of a second, or one-half the time required for the wave to pass a given point. Hence the emf. at the lower end of one wire will have a positive maximum when the emf. at the lower end of the other wire has a negative maximum. If now the upper ends of the two wires are connected and receiving apparatus is connected across the lower ends of the two vertical wires, a

current will flow in the rectangular circuit so formed and can be detected in the usual manner. The horizontal wires contribute nothing to the effective emf. in the coil circuit.

However, for a wave approaching from a direction perpendicular to the plane of the two coils the emf.'s induced in the two vertical wires will be exactly in phase, and the emf. at the lower end of one vertical wire will reach a maximum at the same instant as the emf. at the lower end of the other vertical wire, and no current will flow in the rectangular circuit.

A similar explanation will obtain for a wave length other than twice the distance between the two vertical wires. For a given wave length the maximum instantaneous potential difference will exist across the lower ends of the two wires for a wave approaching in the direction of the plane of the two wires, and no potential difference will exist for a wave approaching perpendicular to this direction.

The rectangular circuit, consisting of the two vertical wires and the two horizontal cross connections, of course constitutes a coil antenna. Coils consisting of two or more turns of wire can be regarded as equivalent to vertical antennas of two or more times the height of the side of the coil.

Another way of regarding the action of the coil antenna is to consider it as an inductance coil which is threaded by the magnetic field of varying intensity which is associated with a radio wave. As pointed out in Section 128, this varying magnetic field is at right angles to the direction of travel of the wave, and it is horizontal. When the wave is traveling in the plane of the coil, the maximum number of lines of magnetic force are linked with the coil. When the wave is traveling in a direction perpendicular to the plane of the coil, no lines of magnetic force are linked with the coil and no emf. is induced in the coil.

It is obvious that if the coil is mounted on a frame which can be rotated about a vertical axis, then for a wave approaching from a given direction the position of the coil can be adjusted so that zero signal will be obtained in receiving apparatus connected in the coil circuit. The adjustment of the position of a coil for zero signal is analogous to the adjustment of the arms of a Wheatstone bridge (Sec. 27) to obtain zero current

in the galvanometer or other detecting apparatus used with the bridge.

Constants and Design of Coil Antennas.—The turns of a coil antenna possess a distributed capacity of their own, and the coil has a natural or fundamental wave length of its own. The fundamental wave length of a coil antenna is the wave length which is radiated by the coil when oscillating freely by itself without being loaded with any other capacity or inductance (Secs. 114, 144, 145). As a guiding rule, it may be stated that a coil antenna should not be used to receive waves which are shorter than about two or three times its fundamental wave length. However, when not used for direction-finder purposes, very satisfactory results can be obtained by using a coil near

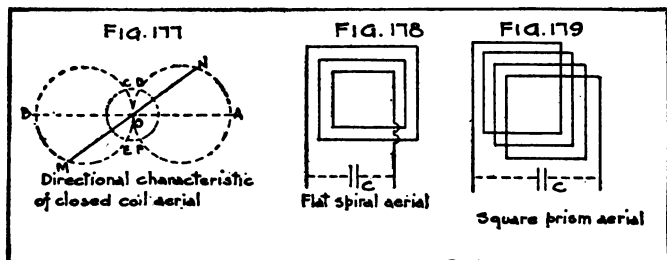

its natural wave length. That is, to receive short waves a coil of small inductance and small distributed capacity should be used. Such a coil must have few turns. To receive longer waves, coils of a larger number of turns may be used. Experience shows that best results are obtained with one or two turns embracing a large area for use with short waves, and for long waves coils with 20 to 30 turns, or even 100 turns, not so large in area.

It is, of course, desirable to make the received current as large as possible. It is found that in a coil antenna turned in the direction of the approaching waves the received current is greater, the larger the number of turns of wire on the coil, the greater the area of the coil and the greater its inductance. The current varies directly as the area, directly as the number of turns, inversely as the resistance, and inversely as the wave length of the wave which is being received.

It would seem at first sight that the increase in resistance due to increasing the number of turns and their area would be offset by the rapid increase of the inductance with the number of turns and the area of the coil. The resistance to high-frequency currents is, however, dependent on the wave length and increases rapidly as the latter approaches the value of the fundamental wave length of the coil.

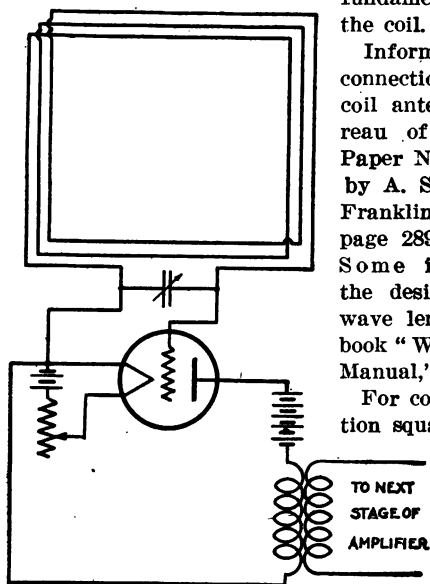

FIG. 179-A

SIMPLE COIL ANTENNA CIRCUIT.

be the most suitable. The wire may be wound in a flat spiral (Fig. 178) or on the surface of a square frame (Fig. 179). With flat spirals only a few turns are used, since the inner turns rapidly become less useful as the area diminishes. The spiral type of coil is comparatively little used in the United States.

The usual type of coil antenna consists of one or more turns of wire wound on a square or rectangular frame. One or two turns of copper wire wound on a simple wooden frame 3 or 4 feet square will make a simple coil which will be suitable for some purposes. For indoor use for all ordinary purposes the

Information of interest in connection with the design of coil antennas is given in Bureau of Standards Scientific Paper No. 354 and in a paper by A. S. Blatterman, Journal Franklin Institute, volume 188, page 289, September, 1919. Some information regarding the design of coils for short wave lengths is given in the book "Wireless Experimenter's Manual," by E. E. Bucher.

For convenience of construction square coils are found to

wire used for a coil antenna may be No. 20 or No. 22 ordinary insulated copper wire, with solid conductor.

The spacing of the turns of a coil depends on the allowable capacity of the coil. Spacings of one-half inch and 1 inch are common; a spacing of one-quarter inch is also used sometimes.

The capacity of a coil of given dimensions increases with the number of turns, at first rapidly, and then more slowly. With the wires close together, the capacity is a maximum and grows rapidly less when the wires are separated, until a certain critical spacing is reached, beyond which the capacity changes very slowly.

For a square coil 8 feet on a side the wires should be placed at least 0.35 inch apart; for one 4 feet square, 0.2 inch; and for a 2-foot coil, one-eighth inch. Increasing the distance between the wires decreases the inductance of the coil; at the same time it reduces the capacity. However, it is found that, for a given length of wire, properly spaced as just indicated, the fundamental wave length of the coil is about the same with different dimensions. This fact is illustrated in the following table, where 96 feet of wire are used in each case.

Characteristics of coil antennas.

Length of a side of the square (feet).	Number of turns.	Spacing of wires (inch).	Inductance (microhenries).	Capacity (micro-microfarads).	Fundamental wave length (meters).
8	3	1	96	75	160
6	4	1/2	124	66	170
4	6	1/4	154	55	174
3	8	1/8	193	49	183

These coils should be used with a condenser of sufficient capacity to bring them into resonance at 500 to 600 meters. The first coil would be most suitable for these wave lengths on account of its small high-frequency resistance and greater effective area.

The following observations, taken on actual coils, show the effective wave-length ranges of different types of construction for a given capacity of tuning condenser, connected directly across the coil terminals, as shown in the circuit of Fig. 179-A.

Coil, 5 feet square, spacing of turns in each case, one-half inch. Using variable condenser having maximum capacity 0.00065 microfarad, minimum capacity 0.00004 microfarad.

With 4 turns..... $\lambda=200$ to 400 meters.

With 8 turns..... $\lambda=350$ to 700 meters.

With 16 turns..... $\lambda=500$ to 1,000 meters.

Coil, 5 feet square. Spacing of turns, one-half inch. Using variable condenser having maximum capacity 0.00140 microfarad, minimum 0.000045 microfarad.

With 4 turns..... $\lambda=380$ to 650 meters.

With 8 turns..... $\lambda=400$ to 950 meters.

With 16 turns..... $\lambda=675$ to 2,300 meters.

Coil, 4 feet square. Four turns, spaced 1 inch. Using variable condenser having maximum capacity 0.00140 microfarad, minimum 0.000045 microfarad, $\lambda=180$ to 500 meters.

Coil, 4 feet square. Four turns, spaced 1 inch. Using variable condenser having maximum capacity 0.00060 microfarad, minimum 0.00004 microfarad, $\lambda=150$ to 350 meters.

Additional data on 4-foot coils is given in the following table:

[Wave-length range in meters for various values of capacity across coil terminals, using circuit of Fig. 179-A. Coil four feet square, wound with No. 20 double cotton-covered copper wire, turns spaced one-half inch. Above 24 turns the winding is sectioned and is wound with 2, 3, 5, or 10 conductors in each of 24 slots, as stated, the entire winding consisting of 24 groups of turns connected in series, the wire composing each group being continuous.]

Number of turns.	Condenser capacity (microfarads).					Remarks.	
	0.00005	0.0001	0.0005	0.001	0.002		0.003
1.....		65	128	178	250	310	
3.....	130	155	290	400	550	675	
6.....	230	280	500	710	1,000	1,200	
12.....	430	490	920	1,250	1,700	2,050	
24.....	760	880	1,600	2,100	3,000	3,600	
48.....	1,550	1,775	3,150	4,300	6,000	7,000	24 slots, 2 turns per slot.
72.....	2,200	2,650	4,800	6,400	8,800	11,000	24 slots, 3 turns per slot.
120.....	3,930	4,500	7,900	10,000	14,700	17,700	24 slots, 5 turns per slot.
240.....	7,600	9,000	15,650	20,500	27,200	32,900	24 slots, 10 turns per slot.

NOTE.—Condensers having maximum capacities from 0.0005 to 0.003 microfarad may be expected to have a minimum capacity of about 0.00005 microfarad. Hence, from the table, with a condenser of maximum capacity of 0.001 microfarad, and three turns on the 4-foot coil, the wave-length range will be from 130 to 400 meters.

The distance over which coil antennas can be used for the reception of field transmitting sets is, of course, short. When used to receive high-power stations, however, very good results may be obtained. With good amplification the high-power European stations can be heard in Washington, using coil antennas such as have been described. An instance is on record where all the great European stations were received in France on a coil only 18 centimeters square, having 200 turns. On a coil 10 inches in diameter signals have been received in Paris from the arc station at Annapolis.

Very compact, self-contained, receiving sets can be made using coil antennas. A successful receiving set has been made at the Bureau of Standards in a small suit case only 7 by 11 by 18 inches, containing a coil antenna and six electron tubes, type N (see Sec. 193). Good signals from near-by stations can be received with this set.

The name "resonance wave coil" has been applied to a coil antenna consisting of a large number of turns of very fine wire wound on a tube a few inches in diameter. When one terminal of such a coil is connected to ground and the other end left free, and a turn or two of wire coupled to the coil and connected to the input of a good amplifier, signals can be received from a considerable distance. Such a device, however, does not act entirely as a coil antenna.

It is not necessary that a coil antenna be entirely insulated from ground, although this is desirable. Signals can be received with a single-turn coil having the lower cross connection completed through the ground. Thus, in a large building having two perpendicular pipes, perhaps 30 feet or more long and a similar distance apart, running direct from the ground up above the roof, a workable single-turn coil antenna can be constructed by simply connecting the upper ends of the pipes by a wire and inserting the receiving apparatus in the middle of the wire. The current flows from the top of one pipe down that pipe, through the ground, up the other pipe, and across the connecting wire through the receiving apparatus to the top of the first pipe. Good results have been obtained with such a single turn coil, and it has been found to have well-marked directional properties. Since it is always grounded, it is at all times protected against lightning. If it is not convenient to lo-

cate the receiving apparatus on the top floor of the building, a pair of wires may be tapped in on the upper connecting wire and run down to a lower floor. On account of the large size of a loop of this kind it is not well adapted for the reception of waves less than about 1,000 meters in length, the effective working wave length range of a particular loop depending of course on its dimensions.

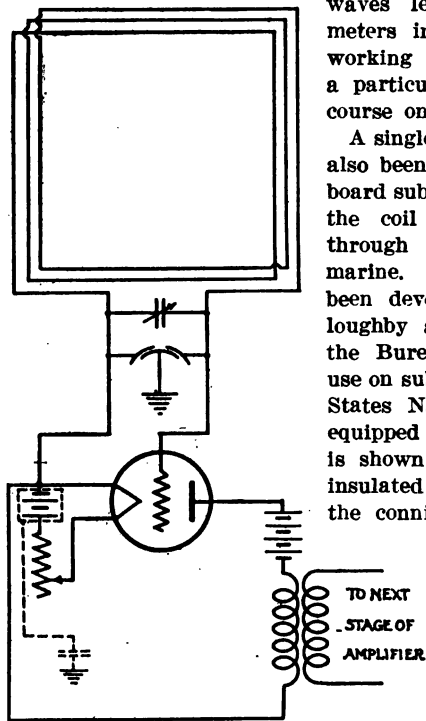

FIG. 179-B.

**COIL ANTENNA CIRCUIT WITH BALANCING CONDENSER,
FOR USE AS DIRECTION FINDER.**

transmit and receive when completely submerged, and it is therefore possible for a submerged submarine to remain in communication with ship and shore stations and other submarines. Good signals have been received from European long-wave stations on submarines off the New England coast when the top of

A single-turn coil antenna has also been developed for use on board submarine boats, in which the coil circuit is completed through the hull of the submarine. This type of coil has been developed by J. A. Willoughby and P. D. Lowell, of the Bureau of Standards, for use on submarines of the United States Navy. A submarine equipped with this type of coil is shown in Fig. 179-C. Two insulated wires are run from the conning tower of the submarine through insulated supports,

and one wire is fastened to each end of the hull, to which it is electrically connected. Tests have shown that a submarine equipped with such a single-turn loop may both

the loop was submerged 8 feet below the surface. Signals have been successfully transmitted from a submarine to a distance of 3 miles, with the top of the loop submerged 9 feet below the surface, using a 1-kilowatt transmitting set.

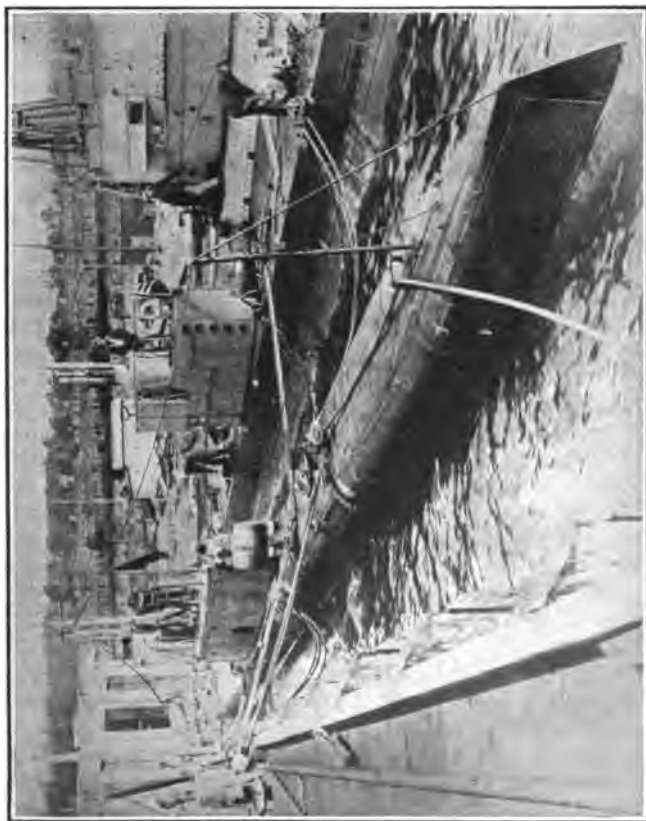

FIG. 179-C.—Submarine equipped with single-turn loop antenna.

152. Direction Finders.—In Section 146 the directional effect of several types of antenna has been discussed. The coil antenna is much more markedly directional than any of the other types ordinarily used. The directional characteristic of a coil antenna

is shown in Fig. 177, and consists of two equal circles, tangent. As has been stated, in reception the strongest signal is received when the transmitting station being received is located in the plane of the coil. In Fig. 177 the coil antenna can be considered to be fixed in position with its plane in the direction BOA and its vertical axis passing through the point O . The maximum signal will then be received from a transmitting station located in the direction OA , or in the direction OB , and the current received from a station located in the direction OA is indicated by the length of the line OA .

The strength of the current received from a transmitting station located in another direction, such as ON , is indicated by the length of the line ON . From a station located in a direction perpendicular to the line OA , no signal at all will be received.

It is evident that with the curve of Fig. 177 the characteristic is symmetrical with reference to a plane through O perpendicular to the line BA , and that the current received from any direction, such as ON , is the same as the current received from the opposite direction, differing by 180 degrees, such as OM .

If a coil antenna is mounted on a vertical axis so that it can be rotated freely, and a curve is plotted showing for a wave approaching from a particular direction the variations in the strength of the received current as the coil is rotated, there will be obtained the same kind of a curve as the one shown in Fig. 177. A coil so mounted is called a *direction finder*, or *radio compass*.

By rotating the coil while receiving from a particular station it is therefore possible to locate the line of direction of the station. The coil may be for maximum signal and the transmitting station then lies in the plane of the coil. Or the coil may be set for minimum signal and the transmitting station then lies in a direction perpendicular to the plane of the coil. It will be noted by reference to Fig. 177, however, that for a variation of, say, 3 degrees, a much greater change in received current is caused when the coil is at the minimum than when at the maximum. Therefore a much sharper determination of direction is possible by setting on the minimum position, and the minimum method is the one usually used for direction-finder work. One

difficulty with the minimum method is that the minimum signal may be obscured by transmission from another station. The maximum method is not subject to this objection.

It should be noted that with this simple apparatus it is possible to determine only the *line* of direction of the transmitting station, but not its sense. That is, if the line of direction determined is east and west, it is not known whether the transmitting station is located on the east or on the west. Methods for determining the sense of the direction will be discussed later.

A simple coil antenna circuit is shown in Fig. 179-A. The coil is tuned to the wave length of the incoming wave by means of a variable condenser connected across its terminals. These terminals are also directly connected to the input of the electron tube amplifier.

A direction finder is provided with a horizontal graduated circle to identify the position of the plane of the coil. To make a determination of direction, the coil is rotated on its vertical axis until the signals disappear. There will usually be a certain range of angular positions of the coil, perhaps between 1 and 5 degrees, for which no response will be obtained in the detector. For a given coil and a given transmitting station this range depends on the sensitivity of the receiving apparatus and the sensitivity of the ear of the receiving operator. The action can be understood by again referring to Fig. 177. If the radius of the circle, drawn with O as a center, represents the smallest received current which causes a just audible signal in the detecting circuit, then it is evident that for positions of the coil lying within the angles COD and EOF no signal can be received.

To determine the line of direction of the waves the positions C and D may be noted on the graduated scale, for which the signals just disappear and just become audible, respectively, and then the coil is turned about 180° and the two similar positions E and F are sought. By taking the average of the circle readings at C and D and E and F that position of the coil may be determined which lies at right angles with the desired direction. The instrument is set up at the start, so that the scale reading will give directly the direction of the waves

in degrees from the north and south line. This method is, however, not ordinarily necessary when a direction finder has been calibrated, as described below.

The characteristic shown in Fig. 177, consisting of two equal tangent circles, is an ideal characteristic, and fails to take into account several conditions found in practice.

As has been stated, a coil antenna can be considered to act primarily as an inductance. It is, however, an arrangement of wires elevated above the ground, and with the ground forms a condenser. The coil antenna will act as an ordinary condenser antenna to an extent depending on what kind of a condenser it forms with the ground. In considering this condenser we should take into account not simply the capacity of the coil alone to ground but also the capacity of all the receiving apparatus associated with the coil.

Let us return to the consideration of the coil antenna as two ungrounded simple vertical wire antennas having the same length as the height of the coil. The emf. induced by an approaching wave in each wire will tend to cause a current to flow between each vertical wire and the ground, through the capacity of each vertical wire to ground. If the coil system is symmetrical about its vertical axis, and the receiving apparatus associated with the coil is symmetrical with respect to this axis, so that the capacity to ground of each lateral half of the coil and coil circuit is the same, this effect is not important and will not destroy the symmetry of the directional characteristic.

In the circuit shown in Fig. 179-A it will be noted that the filament battery and other apparatus is connected to the left coil terminal, while the right coil terminal is connected only to the grid of the first tube. The filament battery of course has an appreciable capacity of its own to ground, and therefore the system consisting of the coil and its associated apparatus has a greater capacity to ground on the side to which the filament connection is made than on the other side. Other parts of the circuit and the operator's body may also contribute to unsymmetrical capacities to ground. The emf.'s induced in the two vertical sides of the coil will cause a current to flow through the unsymmetrical ground capacities, and this current will flow even when the coil is perpendicular to the direction in which the wave is traveling. The effect is that the directional char-

acteristic of a coil system with unsymmetrical capacities to ground is not the two equal tangent circles shown in Fig. 177, but is a figure shaped like an hourglass, the width of the neck depending on the extent to which the capacities are unsymmetrical. There is an appreciable signal when the coil is at right angles to the direction of the approaching wave, and if the effort is being made to rotate the coil to determine this direction it is much more difficult to determine the position of minimum signal. This troublesome effect can be reduced by placing the batteries as far above the ground as is practicable.

This undesirable effect can be eliminated by use of a "balancing condenser," as shown in Fig. 179-B. This is simply a variable condenser with two sets of fixed plates and one set of moving plates, connected as shown, the moving set of plates being connected to ground. The condenser is adjusted until the capacity to ground on the side of the coil connected to the grid is equal to the capacity to ground on the side connected to the filament. This restores the sharpness of the position of minimum signal. The ground connection of the compensating condenser should be symmetrically placed so that the compensating adjustment of the condenser will be independent of the station being received. Compensation is not particularly important when a coil antenna is being used simply for reception, but is very important when it is being used for direction-finding work.

Coil antennas can be used satisfactorily for the reception of wave lengths of 200 meters, but when used for direction-finding work the simple coil circuit should not be used at wave lengths of less than 300 meters and preferably not less than 450 meters. If the effort is made to use an ordinary coil antenna as a direction finder at a wave length of 200 meters, the effect of the capacity to ground of even a pair of leads 3 feet long may be greater than the effect of the coil antenna proper. If it is desired to use a direction finder for such short wave lengths, a balancing condenser should be used, the batteries, amplifier, and other receiving apparatus should be mounted symmetrically inside of the coil itself and all wiring made symmetrically.

For operating coil antennas on comparatively short wave lengths the method described in Section 205 of reducing the high radio frequency of the input voltage to the amplifier by a beat method to a lower radio frequency may be used to

advantage. The use of such a method of beat reception for this purpose is described in Q. S. T., volume 5, page 24, August, 1921.

In Section 130 reference was made to "strays," or atmospheric disturbances, which often cause serious interference in radio reception. Strays of some kinds come from particular directions, and can be minimized by directional reception; that is, the ratio of signal to strays is increased by directional reception. Coil antennas are often used for this purpose. The combination of a coil antenna and a ground antenna has been found particularly good for eliminating strays.⁹ Such directional reception can also be used for eliminating signals from stations which it is not desired to receive. For long-distance reception in commercial and Government communication, either coil antennas or ground antennas or a combination of both are largely used now. The coil antennas used may, however, be out of doors and of dimensions comparable to those of an ordinary antenna of medium size.

When with a direction finder equipped with an amplifier giving high amplification the signal entirely disappears when the coil is at right angles to the direction of the approaching wave, the direction finder is said to have a "perfect minimum." This can be obtained only with very good balancing. It is evidently very desirable to have a very sharp minimum, both to obtain precise settings and to obtain speed in taking bearings. In order to get a sharp minimum, it is necessary to have a fairly strong signal and a good amplifier, usually a 6-stage amplifier. Under such conditions an experienced operator can often make a very accurate setting with only two swings of the coil.

A coil antenna can be used with a circuit of the type shown in Fig. 239-A, page 427. The part of Fig. 239-A to the left of points A and B should be deleted, and the terminals of the coil antenna connected directly to points A and B. This circuit is particularly advantageous on short wave lengths.

⁹ See the following papers in the Proceedings of the Institute of Radio Engineers: A. H. Taylor, vol. 7, p. 337, August, 1919; A. H. Taylor, vol. 7, p. 559, December, 1919; A. H. Taylor, vol. 8, p. 171, June, 1920; R. A. Weagant, vol. 7, p. 207, June, 1919; G. W. Pickard, vol. 8, p. 358, October, 1920; L. W. Austin, vol. 9, p. 41, February, 1921.

The type of coil for direction finding work described above consists of simply one rectangular inductance coil of one or more turns. Direction finders have been developed in which two similar coils are used, crossed at right angles to each other. Such a direction finder has a directional characteristic which is the resultant of the directional characteristics of the two coils alone, and has advantages for particular purposes. For information regarding this "double-coil" or "crossed-coil" direction finder the reader may refer to any standard treatise on radio communication or to the paper by H. J. Round mentioned at the close of this section.

A direction finder has also been developed in which the circuit is open at the top—that is, there are two vertical sides and one lower horizontal connection. Sometimes the two vertical sides are bent toward each other, but they do not touch. This is one of the early types developed by Bellini and Tosi. This direction finder does not act as a coil antenna, but is a particular kind of a directional antenna. The later form of the Bellini-Tosi direction finder employs two triangular antennas, open at the top, and crossed at right angles. These crossed triangular antennas are used with auxiliary apparatus, as described in books listed at the end of this Section.

Unidirectional Direction Finders.—It has been pointed out above that the simple coil antenna having a symmetrical directional characteristic will give the line of direction of a transmitting station, but will not tell on which side the transmitting station lies. It is evident that if we have an antenna having an unsymmetrical directional characteristic, such as that of the inverted *L* antenna, as shown in Fig. 173-C, it will be possible also to tell on which side the transmitting station lies. In general, it is found that the line of direction can be determined most accurately by using a coil antenna alone with proper balancing, and then afterwards to determine on which side the transmitting station is located by a "unilateral" method, which does not alone give the line of direction so accurately.

To get a direction finder suitable for determining on which side the transmitting station is located, we have only to destroy the symmetry of the coil's directional characteristic in some way. One way to do this is by throwing the balancing condenser

out of balance and inserting in the ground lead of the balancing condenser an inductance and capacity in parallel, by which the coil is tuned as a vertical antenna to the incoming wave length.

Another way is to use an antenna of the condenser type coupled to the coil antenna. The antenna used is ordinarily a short vertical wire erected along the axis of the coil, and is

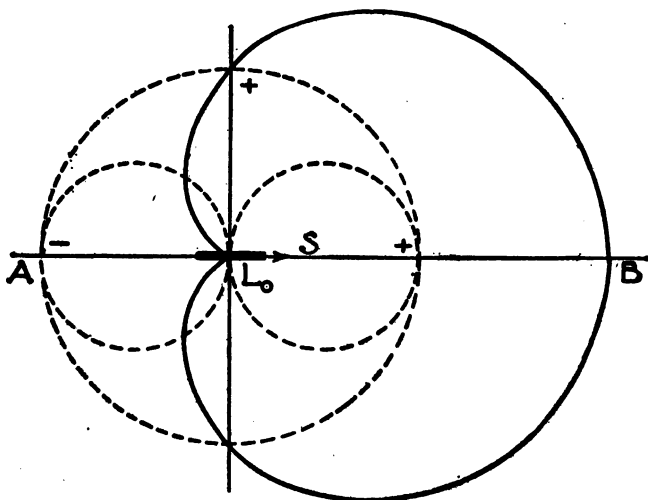

FIG.179-D.

**UNILATERAL DIRECTIONAL CHARACTERISTIC OF SYSTEM
CONSISTING OF COIL AND VERTICAL ANTENNA.**

coupled to the coil antenna circuit in the usual way with a variable coupler. This coupling is adjusted until the strength of the signal from the antenna alone is the same as the strength of the signal from the coil alone, when the coil is in the position for maximum signal. Under these conditions the directional characteristic of the combined system is as shown in Fig. 179-D. In this figure the small dotted circles are the symmetrical directional characteristics of the coil alone. The coil is shown as a heavy line at L_0 . The large dotted circle is

the directional characteristic of the vertical antenna alone. The resultant characteristic is the curve shown in full line passing through *B*. It is evident that for a wave approaching from *B* a good signal will be received, while for a wave approaching from *A* practically no signal will be heard.

It is often not necessary to use a unilateral connection to determine on which side a station lies. Thus in the case of a direction-finder station located on the coast which is receiving signals from a ship it is definitely known that the ship can be on one side only. When a direction finder is used on a ship which wishes to determine the bearing of another ship, however, the unilateral method is desirable in general.

With a coil antenna properly adjusted for unidirectional reception it is possible in Washington to receive signals from San Diego, Calif., while the station at New Brunswick, N. J., is transmitting, although the directions of San Diego and New Brunswick from Washington are nearly in the same straight line.

Distortion of Wave.—When possible a coil antenna used as a direction finder should be used in a location well removed from buildings, trees, and, as far as possible, from any metal of any kind. Such objects distort the wave front and an erroneous determination of direction may be made. Neighboring masses of metal having a natural frequency of oscillation approximately the same as that of the wave being received are likely to cause particularly bad errors in determinations of direction. The Bureau of Standards has used direction finders in the immediate neighborhood of the Washington Monument and has investigated the distortion of the wave front in that locality for different wave lengths. At a wave length of 800 meters the maximum error occurred in the reading given by the direction finder, showing that the natural wave length of the Monument is about 800 meters. When a direction finder is used on board ship, it is of course not possible to get away from all sources of distortion, but the effort should be made to get as far away as possible from such objects, and to have such distorting objects as are present arranged as symmetrically as possible with respect to the center line of the ship from bow to stern. By calibrating a direction finder, as described below, the errors caused by such distortion can be corrected.

When a coil antenna is used in a closely built-up city block it will seldom give accurate bearings because the wave tends to follow the electric wires in the street and other metal masses which run largely in the length of the block.

Undamped waves of long wave length are particularly likely to have their wave front considerably distorted, even when well removed from metal and other objects. Such distortion is especially marked at sunrise and sunset. (See A. H. Taylor, Bureau of Standards Scientific Paper No. 353; 1919.)

Calibration.—After a direction finder is installed in as favorable a location as possible it should be *calibrated*, as is usually done with measuring instruments of all kinds. The direction finder receives signals from a station whose direction is known by other methods, and the difference between the observed bearing and the true bearing is noted. This is done for as many different directions as convenient, and a curve is plotted showing the corrections which must be made to get the true bearing. Points for the calibration curve should be taken at least every 10 degrees. When a direction finder on board ship is to be calibrated, the ship may be navigated in a circular course in sight of a transmitting radio station, and simultaneous visual and radio bearings taken. Information regarding the calibration of direction finders will be found in the paper by Kolster and Dunmore, mentioned at the close of this section.

Applications of Direction Finders.—One of the most important applications of the radio direction finder is in navigation. A ship lost in thick fog can determine its position and set a course if it is equipped with a radio direction finder. By communicating by radio with direction-finder stations on the shore it can also determine its position. This application is of great practical importance, since many lives and much property may be saved if a ship can be navigated correctly in dangerous waters in thick weather. In thick weather the beam of light from lighthouses does not penetrate far, and the observed direction of sound signals sent out from lighthouses may vary a great deal from the true direction.

The Bureau of Standards has developed a system of radio direction finding for use on ships which is very simple and accurate. Two or more radio transmitting stations are erected

at points in the neighborhood of a harbor and automatically transmit characteristic signals during a fog, each station having a different characteristic. Thus one station may transmit dots in groups of three, a second may transmit dots in groups of two, and a third may transmit dots in groups of twenty or more. The navigator takes successive bearings on each of the transmitting stations. The position of the ship is then easily determined by plotting the bearings on a map.

In cooperation with the Bureau of Lighthouses, the Bureau of Standards has installed transmitting equipment for this purpose at three light stations at the approaches to New York Harbor—Fire Island Lightship, Ambrose Channel Lightship, and the light station at Sea Girt, N. J. Radio transmitting stations intended for this service are called "radio beacons." These three radio beacons are now regularly in commission, and any ship approaching New York which is equipped with a radio compass can get bearings. The Bureau of Standards has also designed a coil for use on shipboard and has installed such a coil direction finder on the lighthouse tender *Tulip*. This direction finder is shown in Fig. 179-E. Accurate determinations of direction can be rapidly made by the navigator of the ship; it is not necessary that radio bearings be taken by an experienced radio operator. This system has proved to be very satisfactory, and plans are being made to establish other radio beacons at other light stations in the United States. For further information regarding this system see the paper by Kolster and Dunmore mentioned at the close of this section.

San Francisco Light Vessel has recently been equipped and placed in commission as a radio beacon.

There is another system of applying the radio direction finder to navigation in which a ship desiring to learn its position is not equipped with a direction finder but simply with radio transmitting apparatus. On shore there is a group of direction-finder stations connected by a land wire. The ship sends out a request for its position, which is received by the several stations on shore, and each shore station takes a bearing and transmits the observed bearing to a central control station, which plots the bearings and determines the ship's position, which is transmitted to the ship by radio. In this method considerable time may elapse between the request for position and the return of this information from the central control station, and the delay



FIG. 179-E.—Bureau of Standards type of direction finder installed on lighthouse tender *Tulip*.

is necessarily greatest in the thickest weather, when every ship wants radio bearings, and the interference caused by various ships transmitting simultaneously may be serious.

The radio direction finder is also very useful on airplanes. A number of turns of wire may be wound on the wings of an airplane and used as a coil antenna, and as a direction finder. When it is desired to do direction-finding work on a large airplane it is usual to mount a small rotatable coil aft in the fuselage. The direction finder will permit flying at night or in thick weather, when flying would otherwise not be possible. The use of direction finders on airplanes is in itself an important problem on which a great deal of work has been done and a considerable number of papers have been published.

On airplanes considerable interference may be caused in receiving signals by the ignition system of the engines. This may be considerably reduced by very careful shielding of all the wiring of the ignition system.

The direction finder has found important uses in military operations, and can be used for determining the positions of enemy stations of various kinds.

Coil Transmitters.—Coil antennas can be used for transmitting as well as for receiving, although at the present time their use as transmitters is much less important. Coils are used for transmitting, in most cases, when a transmitted wave having a marked directional characteristic is desired. It has been found that two similar coils mounted on the same axis perpendicular to each other give a directional characteristic which is very useful for some purposes. Coil transmitters have been employed to aid a ship or an airplane to determine its direction from a fixed transmitting station. If desired, a course can be set for the transmitting station. As has been mentioned, the single turn loop installed on a submarine has been used for transmitting.

The use of a coil antenna may be particularly advantageous on small boats when conditions prohibit elevated structures of any kind. Thus on a lifeboat, it is not possible to have any elevated wires strung over the boat, because they would interfere with the throwing of lines. The Bureau of Standards, in cooperation with the U. S. Coast Guard, has recently developed a single-turn coil antenna for use on lifeboats of the Coast

Guard. A 36-foot motor-driven lifeboat with heavy metal keel has been equipped with a single-turn coil antenna of which the metal keel formed a part. Two-way radiotelephone conversations have been maintained between the boat and the shore, using transmitting apparatus of low power.

For further information regarding coil antennas and direction finders, the reader may refer to:

J. H. DELLINGER. Principles of Radio Transmission and Reception with Antennas and Coil Aerials. Bureau of Standards Scientific Paper No. 354: 1919.

F. A. KOLSTER and F. W. DUNMORE. The Radio Direction Finder and Its Application to Navigation. Bureau of Standards Scientific Paper No. 428: 1922.

F. A. KOLSTER. Blindfold Navigation—By Radio. Shipping, vol. 13, p. 13, Feb. 25, 1921.

G. W. PICKARD. Proceedings Institute Radio Engineers, vol. 8, p. 358, October, 1920.

S. BALLANTINE. Year Book of Wireless Telegraphy, 1921. Page 1131.

H. J. ROUND. Direction and Position Finding. Journal Institution Electrical Engineers (London), vol. 58, p. 224, March, 1920. Science Abstracts B No. 428, April, 1920.

J. ROBINSON. Method of Direction Finding by Wireless Waves. Radio Review, vol. 1, p. 213, February, 1920, and vol. 1, p. 265, March, 1920. Science Abstracts B No. 429, April, 1920.

CHAPTER 5.

APPARATUS FOR TRANSMISSION AND RECEPTION

(Exclusive of Electron Tubes.)

A. Apparatus for Damped Wave Transmission.

153. **Function of Transmitting Apparatus.**—Electric waves, by means of which radio communication is carried on, are produced by the transmitting apparatus. Power must be supplied by some kind of electric generator; this must be converted into high-frequency currents which flow in the transmitting aerial and cause electric waves which travel out through space. The waves may be undamped or damped. Damped waves consist of groups or trains of oscillations repeated at regular intervals, the amplitude of the oscillations in each train decreasing continuously. The number of these trains of waves per second is some audible frequency. When such waves strike a receiving apparatus (described later), they cause a sound in the telephone receiver. Signals are produced by means of a sending key, which lets the trains of waves go on for a short length of time (producing a dot) or a longer time (producing a dash).

The principles of damped and of undamped waves are the same in many respects, so that much of what is told regarding apparatus for damped waves applies to apparatus for undamped waves as well. Particular attention is first given to damped waves, since the apparatus is simple and easily adjusted, and is suitable for portable sets and for short-distance communication.

The most important type of apparatus used for generating damped waves is the spark gap, including the rotary gap and the quenched gap. For field use, for emergencies, and for amateur communication, where low power is sufficient, the induction coil is sometimes used. For generating undamped waves the important sources are the high-frequency alternator, the arc converter, and electron tubes. The timed spark gap gives waves which are practically undamped. When an undamped wave is interrupted at the transmitting station at an audible frequency by a "chopper," the wave radiated affects receiving apparatus in some ways as if it were a damped wave.

154. **Simple Spark Discharge Apparatus.**—Damped oscillations are produced when a condenser discharges in a circuit containing inductance. The condenser is discharged by placing it in series with a spark gap and applying a voltage to it high enough to break down or spark across the gap. As explained in Section 115, the oscillations produced when the condenser discharges in such a circuit are damped and soon die out. Methods of producing a regular succession of such condenser discharges are explained in the following. A high voltage must be applied to the condenser at regular intervals. This is done by the use of a transformer. Through the primary of the transformer is passed either an alternating current or a

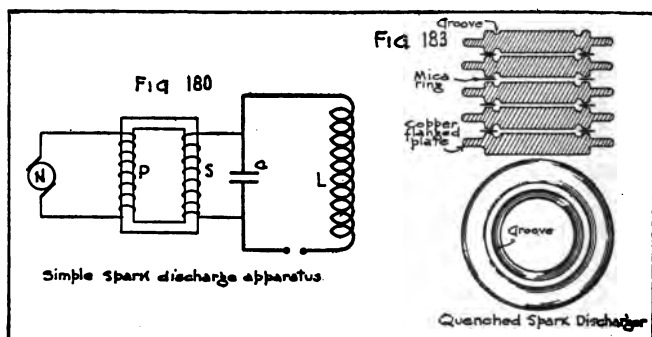

current regularly interrupted by a vibrator operated by the transformer (induction coil). For the use of the induction coil, as in radio trench sets, see Section 157. The principle is best studied first in the alternating-current method.

In Fig. 180, *P* and *S* are the primary and secondary of a step-up transformer (Section 58), which receives power from an a.c. generator. The primary may be wound for 110 volts, and the secondary for 5,000 to 20,000 volts. By means of the transformer the condenser *C* is charged to a high voltage, and stores up energy. When the voltage becomes great enough it breaks down the spark gap and the discharge takes place as an oscillatory current in the inductance coil *L* and its leads. See Section 115. The main discharge does not take place through the turns of *S* on account of its relatively high impedance. The

transformer is sometimes still further protected from the condenser discharge by inserting choke coils (not shown in Fig. 180) in the leads between the transformer and condenser. These obstruct the high-frequency current, but do not hinder the passage of the low-frequency charging current into the condenser. Fig. 181 shows a transformer used in radio sets.

The standard generator frequency is 500 cycles per second. This causes the condenser to discharge 1000 times a second, once for each positive and each negative maximum if the spark gap

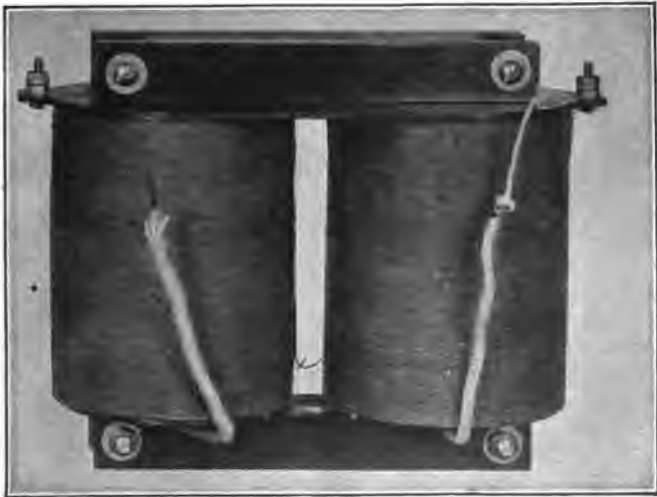

FIG. 181.—Step-up transformer for charging condenser.

is of such length as to break down at the maximum voltage given by the transformer. The number of sparks per second is called the "spark frequency." With the standard spark frequency of 1000 per second the amount of power the set sends out is considerably greater than it would be at a low frequency like 60 cycles per second, because the transmitted radio waves are more nearly continuous, as will be shown later. The radiated wave trains strike a receiving antenna more frequently and their amplitude does not need to be so great to produce the same effect as stronger waves received at longer intervals of time. The

higher frequency produces a tone in the receiving telephone that is more easily heard, because the ear is most sensitive to sound waves of about 1000 per second and also the tone is more easily heard through atmospheric disturbances. A 60-cycle supply may be used if the number of sparks per second is increased by using a rotary spark gap giving several sparks per cycle. See Section 156.

Each condenser discharge produces a train of oscillations in the circuit, and each train of oscillations consists of alternations of current which grow less and less in amplitude. This is illustrated in Fig. 192, and the comparative lengths of the trains of oscillations and the lapse of time between their occurrence are discussed in Section 160.

155. Transmitting Condensers.—Before discussing the means of getting the oscillations into an antenna (Section 160), the apparatus used in generating the oscillations will be described in detail.

The most common types of condensers used in radio transmitting circuits have mica or glass as the dielectric, with tin-foil or thin copper as the conducting coatings. Condensers having air or oil as dielectric are sometimes used, but are bulky. For very high voltages the condenser plates are immersed in oil to prevent brush discharge. For moderate voltages a coating of paraffin over glass jars, especially at the edges of the metal foil, will satisfactorily reduce brush discharge. For calculation of the size of transmitting condenser needed see Section 170.

156. Spark Gaps.—When the gap is broken down by the high voltage it becomes a conductor, and readily allows the oscillations of the condenser discharge to pass. During the interval between discharges the gap cools off and quickly becomes non-conducting again. (See Section 160.) If the gap did not resume its non-conducting condition, the condenser would not charge again, since it would be short circuited by the gap, and further oscillations could not be produced. The restoration of the non-conducting state is called "quenching." A device called the "quenched gap" for very rapid quenching of the spark is described below in this section. Additional appliances for the prevention of arcing are discussed in Section 167.

Plain Gap.—A plain spark gap usually consists of two metal rods so arranged that their distance apart is closely adjustable.

(See Fig. 182.) It is important that the gap be kept cool or it will arc; for that reason the sparking surfaces should be ample. Often the electrodes have fins for radiating away the heat. An air blast across the gap will greatly aid the recharging by removing the ionized air, to which the conducting power of the gap is due. At the sparking surfaces an oxide slowly forms which, being easily removed in the case of zinc or magnesium, is not very troublesome. With other metals in general the oxidation is serious and is rapid enough to make operation unstable and inconvenient.

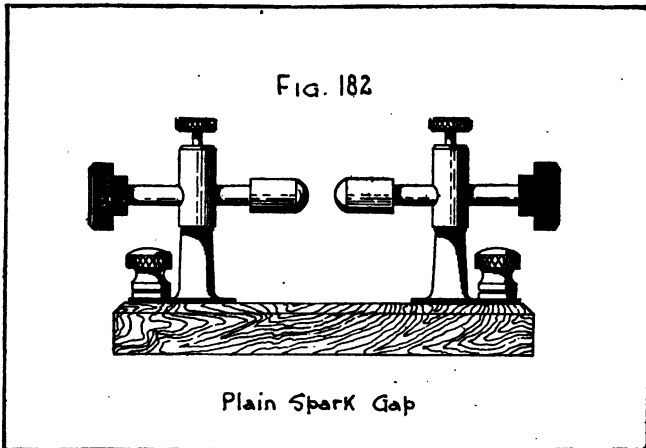

With a given condenser, the quantity of electricity stored on the plates at each charging is proportional to the voltage impressed (Sec. 30), and this can be regulated by lengthening or shortening the spark gap to obtain a higher or lower voltage at the beginning of the discharge. The length of the gap which can be employed is limited by the voltage that the transformer is capable of producing, the ability of the condenser dielectric to withstand the voltage, and the fact that for readable signals the spark discharge must be regular. If the gap is too long, sparks will not pass, or only at irregular intervals. The condenser is endangered also. If the gap is too short it may arc and burn the electrodes. Arcing causes a short circuit of the

transformer, and the heavy current that flows interferes with the high-frequency oscillations. An arc gives a yellowish color and is easily distinguished from the bluish white, snappy sparks of normal operation. Even if no arc takes place, the voltage is reduced by using too short a gap, and this results in reduced power and range. The length for smooth operation can usually be determined by trial.

Quenched Gap.—It is found that a short spark between cool electrodes is quenched very quickly, the air becoming non-conducting almost immediately after the spark is broken down, or as soon as the current falls to a low value. This action is also improved if the sparking chamber is air tight. The standard form of quenched gap consists of a number of flat copper or silver discs of large surface, say 7 cm. to 10 cm. in diameter at the sparking surface, with their faces separated by about 0.2 mm. To provide the necessary total length of gap for high-voltage charging, a number of these small gaps are put in series, so that the spark must jump them all, one after the other. The discs are separated by rings of mica or paper, see Fig. 183, p. 354. Fig. 184, p. 359, shows a commercial type of quenched gap. The motor-driven blower attached serves to keep the discs cool. They are usually made with projecting fins for radiating the heat, and in one design air spaces are provided between the pairs of discs which form the successive gaps. The number of gaps is determined by the voltage, allowing about 1200 volts for each gap. Eight or ten gaps are usually sufficient. (See also Section 123, page 279.)

Until comparatively recently the quenched gap has not been in use on a supply frequency as low as 60 cycles per second. It has recently been found possible to use quenched gaps with 60-cycle supply and still get smooth tones and excellent communication by the use of a variable series resistance in the primary circuit of the transformer, and also by employing a transformer of the resonance type with an unusually high secondary voltage. By altering the series resistance, the spark rate may be changed as desired, as to 60, 120, or 240 per second. This adjustment is somewhat critical and difficult to maintain exactly under conditions where line voltage variations are encountered. Such variations of line voltage result in a roughening of the tone, which does not, however, seem to seriously affect communication.

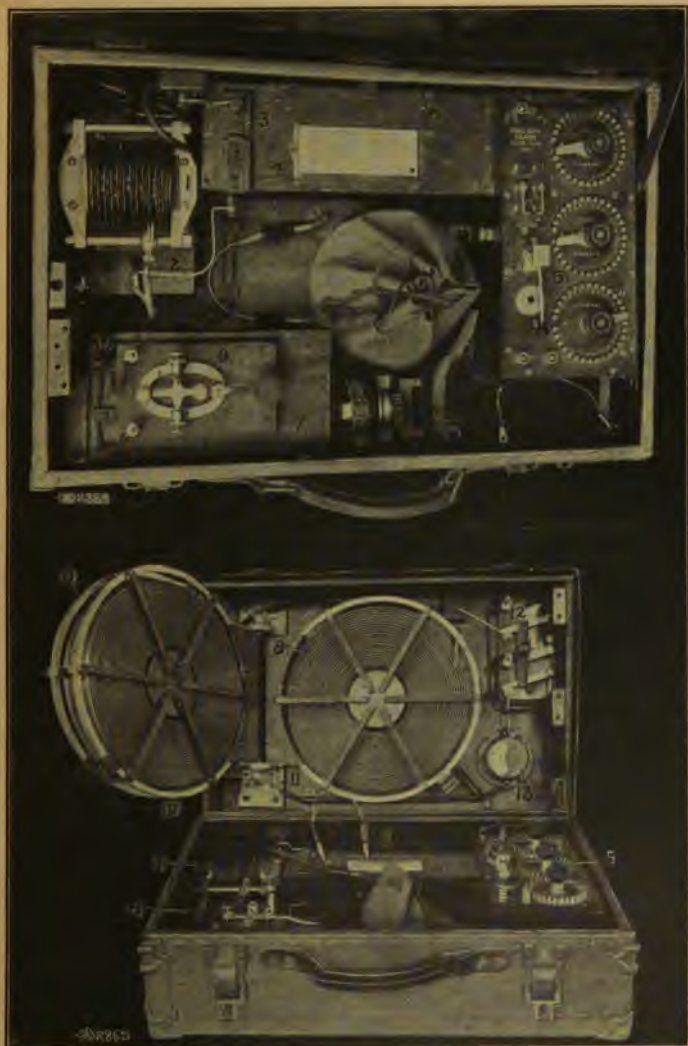

FIG. 184.—Radio telegraph transmitting and receiving set with quenched gap. Signal Corps Type SCR-49. (Pack set.)

- | | |
|----------------------------|---|
| 1. Quenched gap. | 8. Loading inductance. |
| 2. Transmitting condenser. | 9. Primary inductance. |
| 3. Safety gap. | 10. Secondary inductance. |
| 4. Transformer. | 11. Common terminal of primary and secondary. |
| 5. Receiving set. | 12. Antenna switch. |
| 6. Key. | 13. Ammeter in counterpoise lead. |
| 7. Tool box. | |

One advantage of the quenched gap is its quietness of operation, in comparison with the noisy discharge of the ordinary types of rotary gap. This is because of the very short gaps, and the inclosure of the spark.

When 500-cycle supply is used with a quenched gap, it is customary to so adjust the voltage and the number of gaps that there is one discharge per half cycle, or 1,000 sparks per second. (See Fig. 185.)

Unless the antenna resistance is very high, there will usually be found with any quenched gap critical values of coupling between the primary and secondary of the oscillation transformer. The antenna current will be found to decrease when the coupling is either tightened or loosened from one of these critical coupling adjustments. There may be as many as three

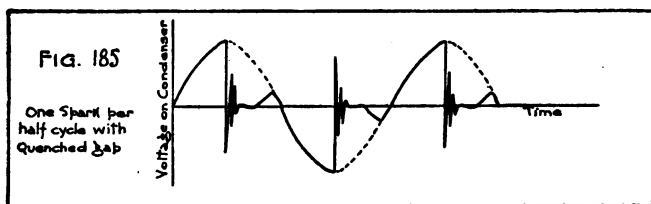

of these critical values of coupling. When the coupling is not adjusted at one of the critical values, the tone usually becomes rough and the wave becomes broad, or even shows two well-marked peaks on its resonance curve. By not properly adjusting quenched gap circuits it is quite possible to produce a very broad wave comparable to the waves of worst interfering qualities produced by other types of sets. Some of these broad-wave adjustments may result in large antenna currents which may seem desirable to the operator, although resulting in far less effective communication than a sharper wave with less antenna current and a clear tone. The desirable qualities of a pure wave are discussed in section 165, page 377.

The adjustment of the generator voltage is also critical and determines to a large extent the purity of both the tone and the wave.

The quenched gap will continue to operate fairly satisfactorily under close coupling, while the usual type of rotary gap

would begin to produce coupling waves under the same conditions. The operation and adjustment of quenched gap sets are further discussed on page 378.

For further information regarding the quenched gap, the reader may refer to "Wireless Telegraphy, with Special Reference to the Quenched Spark System," by Bernard Leggett.

Rotary Gaps.—A rotary gap consists of a motor-driven wheel with projecting teeth. There are usually two fixed electrodes so placed that when a moving tooth on the wheel comes opposite one fixed electrode, another moving tooth is opposite the other fixed electrode. A recent type of rotary gap is shown in figure 186. When two teeth are respectively opposite the two fixed electrodes the current jumps from the one fixed electrode to the wheel, flows across the wheel, and jumps to the other fixed electrode. There are thus two sparks in series. In this way a spark occurs each time that a tooth passes a fixed electrode. Arcing is prevented by interruptions produced by the rotating wheel.

The principal advantages of a rotary gap are:

- (1) It serves as an automatic switch and discharges the condenser at regular intervals, thus producing a steady tone.
- (2) The fanning action of the wheel keeps the gap cool.
- (3) The spark takes place in the compressed air driven ahead of the teeth, and hence the spark is better quenched.

When the rotary gap is mounted on the shaft of the alternator supplying the alternating current of 500 cycles or other frequency, or is driven by a synchronous motor from the same line which supplies the transformer, it is known as a synchronous gap. Such gaps are usually equipped with as many teeth as there are poles on the generator; hence one spark occurs per half cycle, giving the same pitch but a better quality tone than a fixed gap. The fixed electrodes are mounted on an adjustable member which is rotated until the spark takes place at the instant that the alternating voltage on the condenser reaches its maximum values, positive and negative. This means that the teeth must be closest to the fixed electrodes a little after the condenser would reach full charge, since the spark will jump to the moving tooth a little before the tooth is opposite the fixed electrode. Synchronous gaps are also constructed with twice as many teeth as there are generator poles, giving two sparks per half cycle. These sparks are spaced the same dis-

tance on both sides of the peak of the condenser voltage wave. Thus all sparks are still exactly alike and the synchronous quality of the tone is retained, but the pitch is raised an octave.

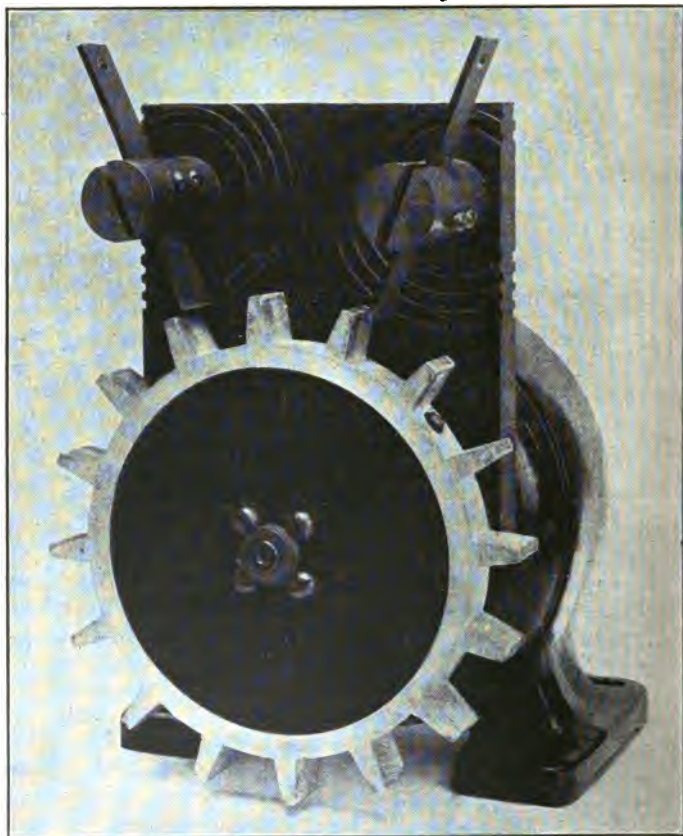

FIG. 186.—Nonsynchronous rotary gap.

This is sometimes regarded as desirable on 60-cycle supply frequency, and such gaps have been used to a considerable extent.

More than two sparks per half cycle can not be produced without having some of them occur at different voltages.

If it is desired to secure a higher pitch than the double-frequency note mentioned above, or if it is not convenient to mount the gap on the generator shaft, it is customary to use a separate motor which runs without any special regard to the generator speed. Such a gap is called a nonsynchronous gap and is usually operated at speeds giving from two to four sparks per half cycle. Better communication is secured with the lower rates of discharge, even though they involve the use of a less desirable tone.

A modified form of rotary gap is shown in Fig. 187.

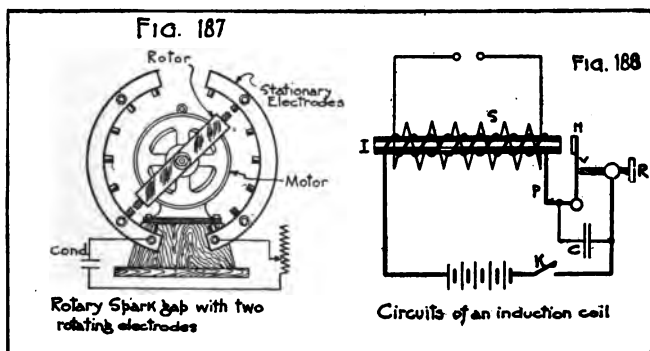

Muffled rotary gaps.—Rotary gaps are frequently muffled to diminish the noise of the discharge. The muffling drum of metal or wood carries insulating bushing through which the fixed electrodes pass. In the case of a synchronous gap the drum is made adjustable so that it can be rotated. Muffled gaps have the incidental advantage that after a portion of the oxygen in the air has been combined with other gases present, a little better operation is obtained. Sometimes a hydrocarbon gas is introduced into the muffling drum. Hydrogen may be drawn from a cylinder, or illuminating gas may be used. Sometimes alcohol is allowed to drop into the muffling drum; the heat of the discharge decomposes the alcohol, producing hydrogen. The presence of the hydrogen in the drum accelerates deionization and results in better quenching, for reasons which

are explained in connection with the arc converter in Section 177, page 413.

Special types of rotary gaps have also been constructed which have in series a number of very short gaps with large surface, one gap being provided for approximately each 1,100 volts. Such gaps are known as rotary quenched gaps, and are usually muffled, or equipped with a discharge chamber which can be filled with a gas, but sometimes operate in the open air. This type of gap produces a note that has the qualities of the note of a 500-cycle quenched gap, but operates on commercial supply frequencies.

When large powers are used, the problem of removing the heat generated in a rotary gap becomes quite serious, since it is difficult to provide a method of ventilation without destroying the effectiveness of the muffler. For medium powers, cooling vanes exposed to an air blast are used.

The plain spark gap is not now used except in small sets; quenched or rotary gaps are the rule. The plain gap can not be properly deionized to allow the condenser to recharge, and it is very difficult, or impossible, to prevent arcing when large power is used, especially with a large number of sparks per second, as in modern practice.

When a rotary gap is used on an airplane, it may be driven by a small fan. The speed of the fan is usually regulated by a self-governing mechanism, so that the speed of the gap does not vary seriously when the speed or direction of the airplane changes. Electron tube transmitters are used considerably for transmitting from airplanes. (See Chapter 6.)

Timed Spark.—A form of rotary gap called the "timed spark" has been developed, which gives substantially continuous or undamped waves. The essential feature of the timed spark transmitter is a series of synchronous rotary gaps mounted on the same shaft, each gap having the same number of electrodes and the electrodes of successive gaps being staggered, so that each gap discharges at a different time. Several forms of circuit have been used. In one circuit each gap is connected in a separate primary circuit and all the primary circuits are coupled to the same antenna circuit. The times of discharge of the various gaps are so arranged that the resultant

wave in the antenna circuit is substantially smooth and continuous. Stations of this type have given very satisfactory service. The stations at Marion, Mass., and Stavanger, Norway, use timed spark transmitters. For further information, the reader may consult A. N. Goldsmith, *Radio Telephony*, page 73, and E. E. Bucher, *Practical Wireless Telegraphy*, page 274. The use of timed spark transmitters is decreasing, because of improvements in other generators of undamped waves, particularly the high-frequency alternator and the arc transmitter.

157. **Simple Induction Coil Set.**—For short distance communication in trenches, and in general for power below $\frac{1}{2}$ kw., it is common to use an induction coil or a power buzzer instead of an alternator and transformer, to charge the condenser. The wiring of an induction coil is shown in Fig. 188. *P* is the primary coil of a few turns (heavy lines); *S* is the secondary of many turns of fine wire; *I* is a laminated soft-iron core magnetized by the primary current; and *H* is a piece of soft iron at the end of a spring forming a sort of vibrating hammer; *R* is an adjusting screw for the vibrator; *C* is a condenser of a few microfarads shunted around the vibrator points to prevent their burning. The vibrator points may be replaced when necessary by drilling a hole and driving in a piece of silver. *V* shows the vibrator points where the primary current is made and broken in rapid succession as long as the key *K* is closed. When current flows, *H* is first attracted by the iron core, breaking the current at *V* after which the spring causes it to return to its first position, remaking the current. The action is then repeated. The frequency of operation depends upon the mass of the hammer *H* and the stiffness and length of the spring. It is similar in that respect to an electric bell. This piece of apparatus is really an open core transformer, the changes of current being produced by the automatic interrupter or vibrator, which is operated by the magnetism of the core. The source of power is usually a storage battery of 8 to 20 volts. Owing to the changes of primary current, rapid changes of magnetic flux occur and produce a high voltage in the large number of turns of the secondary coil.

Referring again to Fig. 180, consider the induction coil put in place of the a.c. transformer. When the coil is put into

operation, with its secondary terminals connected to the condenser and discharge circuit, a continuous stream of sparks will pass across the spark gap as long as the key is pressed.

158. **Operation of Induction Coils from Power Lines.**—Fairly large power induction coil sets are used as emergency transmitters on ships. These employ batteries, so as to be independent of the ship's generator. On land, however, when a battery is not available, it is possible to operate an induction coil from a d.c. 110-volt power line by inserting a rheostat in series. In this case, it is absolutely necessary to shunt the transmitting key with a condenser similar to the vibrator condenser, or else a serious arc at the key will take place at the

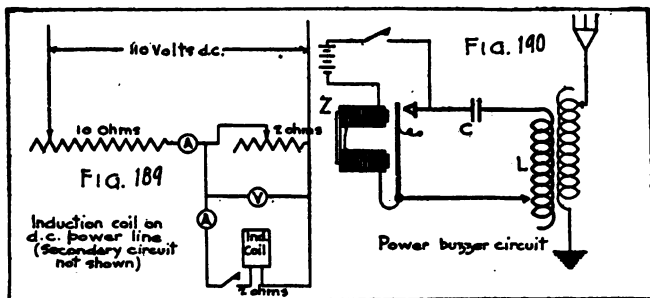

first attempt to signal, and the current will not be broken when the key is released. Of course, the method of inserting a rheostat is very wasteful, since the RI^2 loss in the rheostat is large, much greater in fact, than the power actually used in the radio apparatus.

A scheme to avoid a voltage as high as the 110 volts across the break at the key is to use a voltage divider (see Sec. 15) consisting of two rheostats in series, as in Fig. 189. Suppose the spark coil has 2 ohms resistance in the primary, and requires 10 volts to operate it. If one rheostat is set at 10 ohms and the other at 2 ohms, with the induction coil and key in a shunt around the 2-ohm coil, then the voltage applied to the induction coil will be 10 volts with the key closed. Note that the voltage across the key when open is 18.3 volts.

With a.c. supply the methods are different. One method of operating an induction coil from 110 volts a.c. is to use a small,

step-down transformer to reduce the voltage to an equivalent battery voltage. This requires no series resistance or reactance, and is a fairly efficient method. Induction coils are sometimes operated on 110-volt a.c. power lines by insertion of a series reactance. The vibrator in the primary circuit is not necessary if the supply is 500-cycle, and it is preferable to clamp it permanently in the closed position. The set then becomes similar to Fig. 180. Induction coils may have the primary wound for 110 volts, in which case there is no need for any step-down transformer series reactance, or resistance.

159. Portable Transmitting Sets.—For portable sets, or for Army field use the simplest apparatus for short distance is a small induction coil set, operated from a storage battery. A plain spark gap may be used, for simplicity, but the use of a quenched gap will usually improve the operation. When fairly long distances are to be covered it is advisable to replace the induction coil by a small step-up transformer. A source of alternating current then takes the place of the battery. For a small set this source may be a generator which is driven by hand through gearing. For larger power the generator may be driven by the engine of a motor-cycle or some other gasoline engine.

For short-distance work the condenser may be charged and radio oscillations produced, without an induction coil, by the use of a power buzzer and a storage battery or a few dry cells. See Fig. 190. The buzzer is shown at *Z*. The more voltage applied to it the greater is the charge given to the condenser *C*. When the vibrator arm is at the right in the diagram, the condenser discharges through the inductance *L*. This forms the closed oscillating circuit. The condenser should be comparatively small; the apparatus is limited to short wave lengths.

160. Simple Connections for the Production of Electric Waves.—Up to this point have been shown the means by which an oscillating discharge is produced in a condenser circuit. It is necessary now to learn how the oscillations can be gotten into an antenna so they may be sent out as radio waves. The wiring connections for the different methods are given in this and the following sections, showing first the simplest transmitting connections and then leading up to standard sets.

The simplest possible wave transmitter is a straight wire cut in the middle by a small spark gap. See Fig. 191. If the wire were not cut, and if oscillations could be produced in it, the charges would travel rapidly back and forth owing to the capacity and inductance of the wire and waves would move out into space as explained in Chapter 4. The oscillations taking place in the wire are of the same nature as those in the circuit *CL* of Fig. 180. The student should learn to think of the wire as uncut, for the gap becomes a conductor when the spark is passing. Oscillations are produced by the same means described in Section 154, using a high voltage to start a discharge across the spark gap. This is done by connecting a transformer or an induction coil to the gap. The use of an induction coil is shown in Fig. 191. The two halves of the wire charge up as a condenser until the potential difference rises so high that the insulating property of the gap is broken down. There is then a discharge across the gaps and oscillations pass freely until the energy is spent. The gap then becomes nonconducting again, as has been explained, and permits a renewed charging. The process is repeated as many times a second as the vibrator works.

The interval from one break at the vibrator to the next may be about 0.01 second, while it will take only in the neighborhood of 0.00001 second for the discharge to be completely accomplished (basis of illustration is a wave length of 150 meters, 20 waves to a train). Thus it is seen that there is a comparatively large time interval between successive wave trains, in which the gap may cool and be restored. A sketch of the discharge current is shown in Fig. 192, but the wave trains are not shown nearly far enough apart for the case of a damped oscillator such as that of Fig. 191. To show how relatively large the time interval between successive wave trains is, it might be stated that in this illustration the length of the wave train itself compares with the length of the idle interval between wave trains about in the same ratio as one day compares with three years.

The next theoretical step toward a standard radio transmitting set is to add large metal plates to the outer ends of the straight wires. See Fig. 193. This increases the capacity of the oscillator and causes larger charges to accumulate for the same

potential difference, thus giving a larger flow of current back and forth in the wire and sending out more electric and magnetic lines of force. The strength of signals and the range are thus increased.

It is shown in Section 132 that the lower half of the oscillating system, Figs. 191 or 193, may be replaced by the ground, the action of the upper half remaining as before. Also, it is customary to replace the upper capacity plate of Fig. 193 by

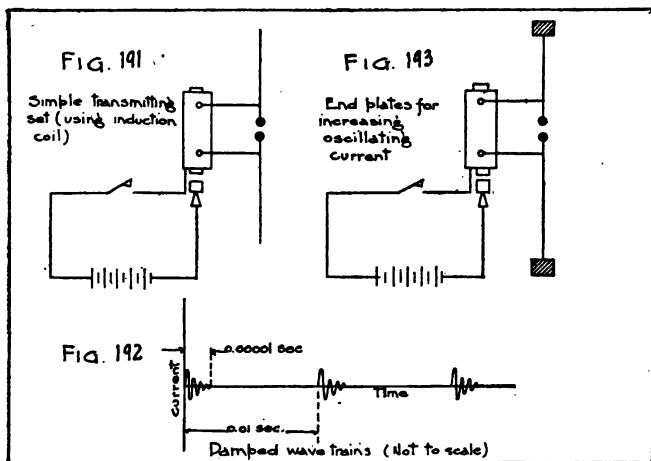

one or more wires, horizontal or nearly so. See Fig. 194. A relatively large capacity can thus be added, and the constructional difficulties and arrangements of support are simplified. This assemblage of wires forms the "antenna." A variable inductance coil inserted in the antenna wire will permit tuning to different frequencies or wave lengths. Thus a simple transmitting outfit is built up.

The arrangement shown in Fig. 194 is sometimes called a "plain antenna connection" to distinguish it from the inductively coupled set explained below. It is a good radiating system, but the waves emitted are of such high decrement that they can not be readily tuned out in receiving apparatus when

one does not desire to receive them. See Section 116. Hence this system is not permissible in general practice.¹ Its advantages besides simplicity are, however, its effectiveness in cases where the sending operator wants all possible stations to hear him, as, for instance, when a ship needs help, and secondly its military use in purposely drowning out or "jamming" other signals which an enemy is trying to receive. The connection is very quickly made by inserting the spark gap directly between the antenna and ground wires and

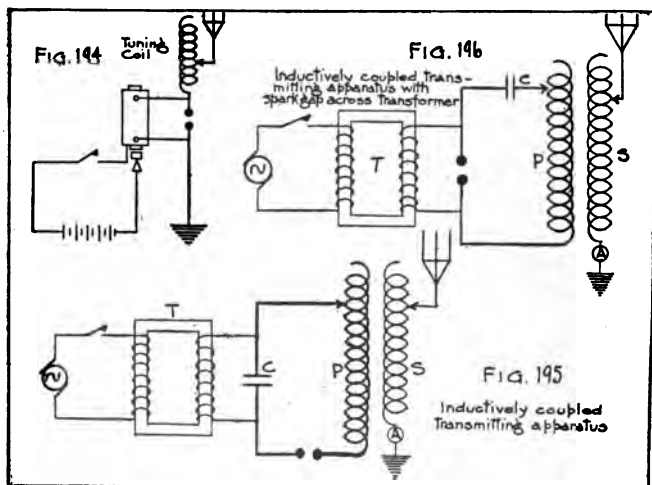

connecting the current source across the gap. Arcing in the gap must be guarded against, and care should be taken not to open the gap too wide, or the antenna insulation may break down.

161. Inductively Coupled Transmitting Set.—Instead of connecting the spark gap directly in series with the antenna it may be placed in a separate oscillating circuit like that of Fig. 180 and this circuit then coupled with the antenna. In the most

¹The radiation of a wave having a decrement per complete oscillation exceeding 0.2 is forbidden by law, except for the transmission of distress signals. See the pamphlet Radio Communication Laws of the United States, for sale by the Superintendent of Documents, Washington, D. C.

common method the coil of the oscillating circuit (called the "closed" circuit to distinguish it from the open or antenna circuit) is coupled inductively to the inductance coil in series with the antenna. The circuits thus become Fig. 195. One of the advantages of this method is that the condenser in the closed circuit may have much greater capacity than the antenna and thus may store more energy for each alternation of the supply voltage; this energy is handed over to the antenna, which thus becomes a more powerful radiator. Other features of the method are given in Section 163 below.

As before, either an induction coil or a transformer with a.c. supply voltage may be used. In Fig. 195 the latter is shown. *T* is an iron core transformer, somewhat similar in construction to the ordinary transformer used in electric light systems. The two inductance coils *P* and *S* constitute what is sometimes called an "oscillation transformer." A hot-wire ammeter is in series with the antenna. The positions of the spark gap and condenser are sometimes interchanged, bringing the spark gap across the transformer. See Fig. 196. There is no practical difference in the operation.

The condenser discharge can not take place through the transformer *T* on account of its very great impedance, but passes across the spark gap and through the few turns of the primary coil *P*, producing a rapidly changing magnetic flux within the coil. The secondary coil *S* is placed near or inside of coil *P*, so that part of the alternating magnetic flux of *P* passes through *S*. There are three principal styles of oscillation transformer, the double helix, hinged coil, and flat spiral types. See Figs. 197, 198, 199. In order to have a low resistance the conductor is usually a copper ribbon of large surface, or edgewise-wound copper strip. The amount of coupling, or the mutual inductance, between them is varied by moving one or both of the pair. Connections are made to such coils by movable clips, so that any desired amount of self-inductance may be used.

The hot-wire ammeter is used for measuring the current in the antenna circuit. For merely tuning to resonance a low-resistance lamp such as a small flashlight lamp may be used in place of the hot-wire ammeter, the maximum current being indicated by the maximum brightness of the lamp filament. If the

current is too great for the lamp, it should be shunted by a short length of wire. The ammeter or lamp may be short cir-

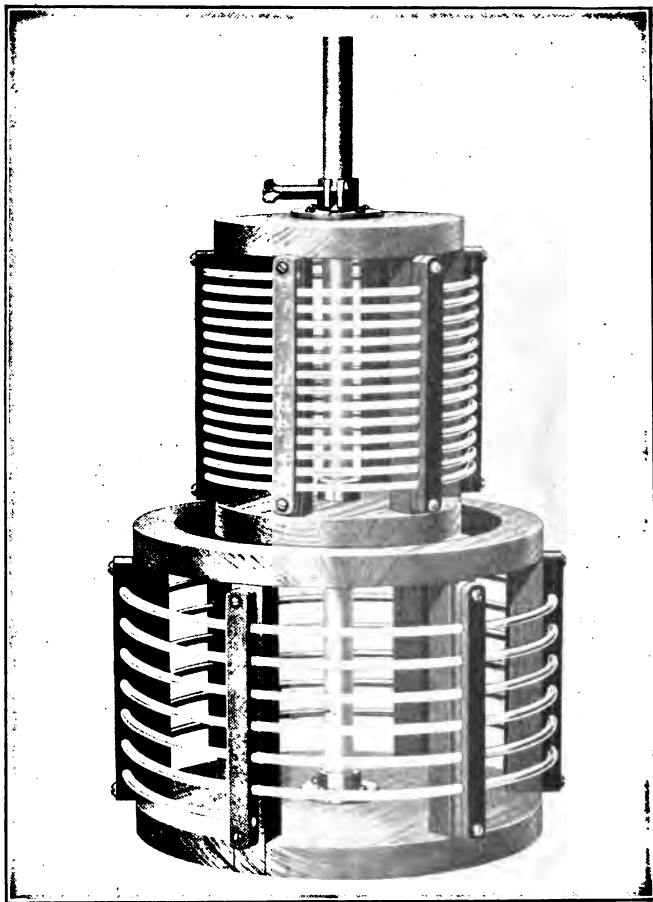

FIG. 197.—Double helix oscillation transformer; coils separated axially. cuit except when actually needed in order to keep the resistance of the antenna circuit low.

162. **Direct Coupled Transmitting Set.**—Direct instead of inductive coupling may be used between the closed circuit and the antenna circuit, as in Fig. 200. (Direct coupling was explained in Sec. 119.) One inductance coil is all that is needed. By the contacts shown, as much or as little of the inductance as desired can be used in either circuit. In order to tune to some wave lengths it may be necessary to have an additional coil in

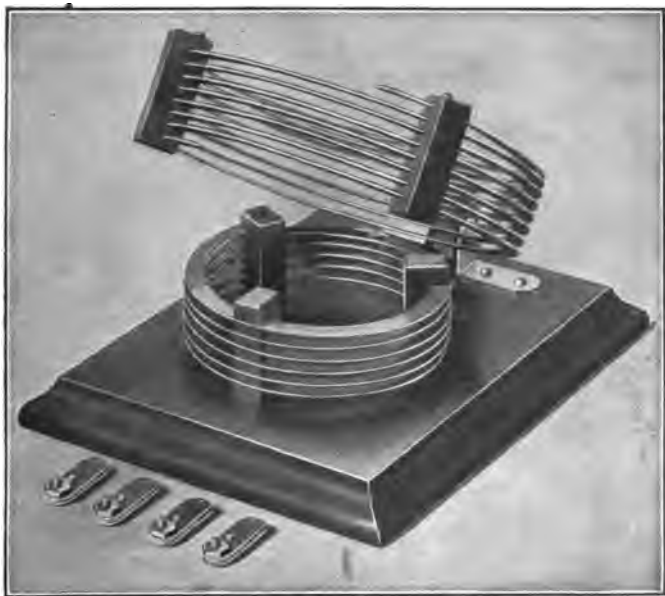
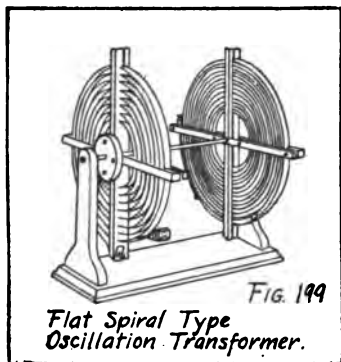

FIG. 198.—Hinged coil oscillation transformer.

series in the closed circuit. By making the part of the inductance that is common to both circuits a small part of the total inductances in the circuits the coupling can be made as loose as desired. Since direct and inductive coupling are strictly equivalent, the discussion of one applies to both.

163. **Comparison of Coupled and Plain Antenna Sets.**—In the plain antenna set of Fig. 194 the spark gap is in series with the antenna. Thus the resistance of the gap is present and helps to

make the decrement of the radiated waves high. While high decrement is an advantage in special cases, as explained in Section 160, it is usually not desirable. When the spark gap is in a separate circuit, coupled either inductively or directly to the antenna, as in Figs. 195 or 200, the resistance of the spark gap does not enter into the antenna resistance. The resistance of the gap is high, and can not be changed much under practical operating conditions, and therefore in a set with plain antenna connection the decrement of the emitted wave is only to a small extent subject to control. If a set with a plain antenna connection is worked at a wave length several times the fundamental of the antenna, a smaller decrement can be obtained, but the power radiated will be considerably reduced.



In a coupled circuit the resistance of the antenna and the resistance of the ground connection are important factors in determining the decrement of the radiated wave. Hence in a coupled circuit, for a given gap adjustment, the decrement of the radiated wave can to a considerable

extent be controlled by varying the resistances of the antenna and the ground connection and by varying the coupling. The varying of the coupling will affect the decrement as well as the "purity" of the radiated wave. In a coupled circuit, with the resistance fixed, increasing the capacity of the primary circuit and decreasing its inductance will decrease the decrement of the radiated wave.

One important advantage of the coupled connection is that the maximum power which can be radiated from a given antenna is considerably greater with a coupled connection than with a plain antenna connection.

Radiation of a sharp wave is especially important in military work. There may be several hundred stations transmitting in the area occupied by an Army corps, and the wave emitted by

even the best spark transmitter may not be satisfactory. The use of the electron tube transmitter (see Chap. 6) is being greatly extended for such work, and spark sets are used only under special conditions.

When a quenched gap is used it would make the decrement much worse if used in the antenna circuit. When used in the closed circuit, however, the oscillations in the closed circuit have such a high decrement that they stop almost immediately and simply start the antenna circuit oscillating, which thereafter oscillates with its natural decrement, which may be small. This is the condition which exists when the proper

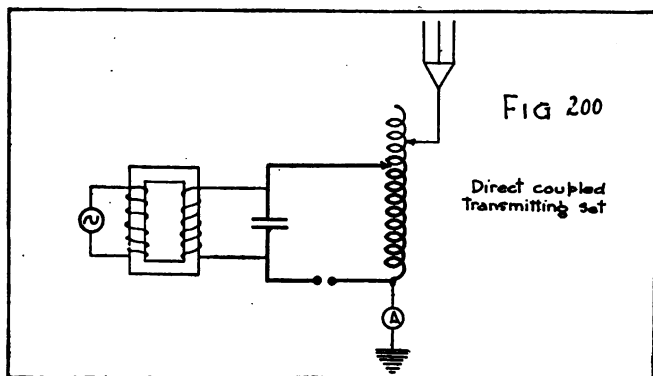

critical coupling is used. Many operators, however, fail to operate quenched gap sets properly adjusted for critical coupling. When a quenched gap is not properly adjusted, the wave may be very broad and the tone may be very poor. (See also page 360.)

On account of the small decrement of the oscillations in the antenna circuit the instantaneous voltages do not reach as high values, with a given current and power output, as they do when the oscillations are strongly damped. Thus the voltages in the antenna are not as great when the coupled circuit is used and the antenna insulators are not as likely to fail.

164. **Tuning and Resonance.**—A very pronounced maximum of current is obtained in the antenna circuit when its natural period of oscillation is the same as that of the primary circuit. This occurs when $L_s C_s = L_p C_p$. (See Chap. 3, Sec. 116.) L_s is

the inductance of the antenna circuit, including the antenna itself, lead-in wire, and the secondary coil of the air-core transformer. C_s is the capacity of the same circuit. L_p is the inductance of the primary circuit, and since the wiring is short the inductance is nearly all in the coil L . Likewise, since C has a large capacity, C_p is practically the capacity of this condenser. It is not necessary in operation to measure any of these quantities. The hot-wire ammeter will show by trials when the products are equal, or a wavemeter will enable the operator to adjust each circuit P and S to the same frequency, or to any desired wave length. The principal case where the inductances and capacities need to be known is in the design of a set which differs from previous sets so much that the proper size of apparatus is not known. To adjust the apparatus to send out long waves, a large inductance may be used in series with the antenna. It is preferable, however, to use a large antenna, thus obtaining large capacity, which stores up large charges and allows a large radiating current.

165. Coupling.—When the antenna and closed circuits are adjusted independently to the same frequency or wave length, and then closely coupled together, waves of two frequencies appear in each circuit. See Section 120. For showing the double wave in radio apparatus, a wavemeter (see Section 112) placed near either of these coupled radio circuits will be found to indicate a maximum response at two different wave lengths. If then the coupling between the two circuits is diminished, the two wave lengths approach each other and the wave length for which the circuits were set, and at a very loose coupling only one wave length will be discernible. Figs. 201 to 204 show resonance curves for the case where the primary and secondary are adjusted separately to 600 meters, and then are coupled by bringing the secondary and primary coils near together (when the coupling is inductive). When the coupling is direct it is made closer by making a larger part of the inductance of each circuit common to both circuits. These effects are more pronounced when a plain or rotary rather than a quenched gap is used.

Fig. 201 might allow of fairly sharp tuning on one of the wave lengths, but only the energy of one wave could be utilized by a receiving apparatus. Figs. 202 and 203 would be the

equivalent of a single wave of very broad shape or high decrement, such that the strength of the signals is nearly the same over a wide range of wave lengths. In Fig. 204 the signals are strong at or near only one wave length, and diminish rapidly if any of the apparatus adjustments are changed. This is said to be a "pure" wave.³ It is desirable to have as sharp a resonance curve as possible, and hence loose coupling is the rule when a plain gap is used. The advantage is that all the power sent out is concentrated into a narrow range of wave lengths, and that receiving stations can tune to the one wave length

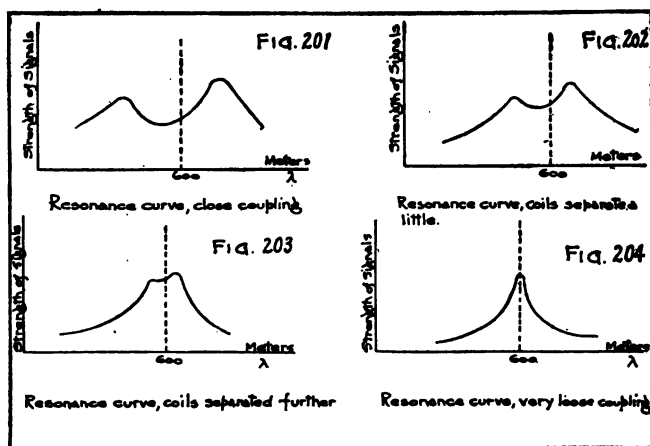

emitted by the transmitting station which they desire to receive and exclude all other wave lengths from other transmitting stations.

Action of the Quenched Gap; Relation to Coupling.—Refer again to the inductively coupled apparatus of Fig. 195 and to the waves of Fig. 154 in Chapter 3. Also refer to the description

³ The United States radio law requires that if a transmitting station emits more than one wave length, the energy in no one of the lesser waves shall exceed one-tenth of the energy in the principal wave. See the pamphlet, "Radio Communication Laws of the United States," issued by the Bureau of Navigation, Department of Commerce. Copies may be secured from the Superintendent of Documents, Government Printing Office, Washington, for 15 cents each.

of the quenched gap in Section 156. The action of the quenched gap is to open the primary circuit, by suppression of the spark at the end of its first train of waves (point *D* in Fig. 154). This prevents the secondary from inducing oscillations in the primary again; that is, from giving energy back to the primary. The secondary or antenna oscillations are not thereafter interfered with by the primary and the antenna goes on oscillating until the energy is all dissipated as waves or heat (see Fig. 155). The length of the train will depend only upon the decrement of the antenna circuit. By reducing the resistance, the dielectric losses, the brush discharges and leakage, the antenna current may be made to oscillate for a comparatively long time, at the frequency for which the set was adjusted. This quenching of the primary avoids the double waves of Figs. 201, 202, and 203, even with close coupling. In fact, the coupling should be close for good operation with the quenched gap. Some care has to be taken in the adjustment of the coupling, but when adjusted properly this gap gives a high pitched, clear note. The wavemeter will readily show when a single sharp wave is obtained (see Section 168), and the sound in the telephone receiver will indicate the proper adjustment for good tone. The quenched gap is very efficient, because the close coupling produces a large current in the antenna.

It is well to note that the principles of operation of the quenched gap and plain gap are exactly opposite. The former aims to stop the primary oscillations quickly, after the secondary has been brought to full activity. The latter aims to keep the primary oscillations going as long as possible, all the time giving energy to the secondary as it is radiated away; the coupling is loose and the primary decrement is kept low. The rapid decrease of the oscillations in a quenched gap circuit is assisted by having a large ratio of capacity to inductance. This has the incidental advantage that the voltages across the condenser and coil are thus kept low.

166. Damping and Decrement.—If the energy in the antenna circuit is dissipated at too rapid a rate, owing either to radiated waves or heat losses, the oscillations die out rapidly and not enough waves exist in a received train to set up oscillations of a well-defined period in a receiving antenna. Such waves are strongly damped and have a large decrement. They produce

received currents of about the same value for a considerable range of wave lengths. Thus selective tuning is not possible.⁸ To increase the number of waves sent out in each wave train from the open circuit (that is, to make the oscillations last longer) the resistance of the circuits must be kept low. When using a plain spark gap the coupling between closed and antenna circuits must be small enough not to take energy too fast from the closed oscillating circuits. At each condenser discharge the primary has a train of oscillations which at best die out long before another train starts (see Fig. 192); these oscillations are stopped more quickly, however, if the energy is drawn rapidly out of the circuit by the antenna. Close coupling is permissible only when a quenched gap is used (see remarks at the end of the preceding section). With any other kind of gap the secondary is kept oscillating by energy continually received from the primary.

A great many factors contribute to the resistance of the antenna circuit, and this must be kept as low as possible. The antenna must have a good low-resistance ground, must use wires of fairly low resistance, and must not be directly over trees or other poor dielectrics. The resistance of the closed circuit particularly must be very low. Heavier currents flow here than in the antenna wires. For this reason the closed circuit wires should be short and of large surface, preferably stranded wires or copper tubing. The condenser should be a good one, free from power loss.

167. Additional Appliances.—A number of additional appliances are necessary or desirable for the operation of a damped wave generating set. The operation is improved by having a variable reactance (iron core inductor) in series with the alternator, to tune the alternator circuit to the alternator frequency. See Bureau of Standards Circular 74, p. 230.

Changes of Wave Length.—In many sets of apparatus it is customary to have connections arranged by means of which different chosen wave lengths, say 300 or 600 meters, can be transmitted without the necessity of a readjustment of the apparatus after each change. An antenna alone without any inductance coil has a natural wave length of its own, dependent

⁸ See also section 116. The United States radio laws require that no station shall transmit a wave having a decrement exceeding 0.2.

upon its inductance and capacity. See Sections 116 and 145. The antenna is usually so designed that its natural wave length is shorter than the wave length to be used, and the wave length is brought up by adding inductance in series or merely by the added inductance of the secondary of the oscillation transformer. In the case of a small antenna, such as that on a small ship, it is necessary to use a large inductance. Since it is desirable to have the coupling loose, a part of the secondary inductance can be in a separate coil called the antenna "loading coil." This loading coil is not coupled to the primary. Fig. 205 shows this arrangement. For a quick change of wave length a single switch is often provided, which, by a mechanism of

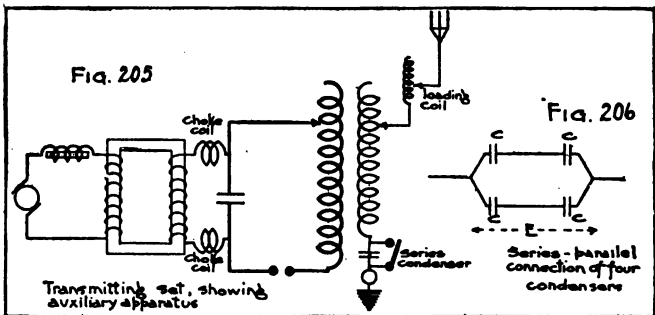

levers, changes simultaneously the adjustments on all three coils. From these coils are taken out taps over which three switch blades pass, adjusting all the inductances to approximately the values needed for the particular wave length desired, keeping the circuits in resonance and at the proper coupling. For fine adjustments an additional variable inductor may be provided in the primary and in the secondary.

Fig. 205 also shows an arrangement whereby the operator can obtain wave lengths *shorter* than the natural wave length of the antenna by inserting a condenser in series (see Sec. 35) in the antenna circuit. In this case the loading coil will be set at zero turns to diminish the wave length. The condenser inserted must be capable of withstanding high voltages similar to those in the main transmitting condenser. By using a small capacity the wave length can be reduced to approach one-half

of the natural wave length. It should not be reduced that much, however, for the radiation is inefficient if the condenser is too small. A zero capacity (an open circuit cutting off the antenna entirely from the ground) would be necessary to produce half-wave length exactly.

Choke coils.—Fig. 205 shows also choke coils to prevent the high-frequency condenser discharge from getting into the transformer and puncturing the insulation. The coils choke down the radio-frequency current but do not obstruct the low-frequency charging current from the transformer. They must be specially designed so that they do not have capacity enough to allow the radio-frequency current to pass. They can often be dispensed with. See also Appendix 9, page 578.

168. Adjustment of a Typical Set for Sharp Wave and Radiation.—The set is assumed to be an inductively coupled set, arranged as in Fig. 205. The first step in adjusting it to work properly is to tune the closed circuit to the wave length which is to be used. This is usually done by varying the primary inductance, which includes the primary of the oscillation transformer. The primary capacity is usually fixed in value and not readily changed. Manufacturers usually mark on the primary variable inductance the wave lengths corresponding to various settings. If this has not been done, it will be necessary to determine the wave length by the aid of a wavemeter having in its circuit a sensitive hot-wire ammeter. The wavemeter is placed at a distance of one or more meters from the coil of the closed circuit, and with the set in operation but the antenna circuit opened, the wavemeter coil is so turned that a small current is observed in the wavemeter ammeter. With the wavemeter set at the chosen wave length the closed circuit inductance is varied until resonance is obtained. If no resonance point is found, it is probable that the closed circuit inductance or capacity is either too large or too small. This inductance should be varied and a resonance point will be located after a few trials. It may also be necessary to increase or decrease the number of condensers used.

The next process is to adjust the secondary inductance and the coupling to obtain a pure, sharp wave; that is, to get as much as possible of the power into the wave length that is to be used. Both primary and secondary circuits are closed and

coupled together, using at first a fairly loose coupling unless the spark gap is a quenched gap. The secondary of the oscillation transformer or the antenna loading coil is varied until resonance is obtained, as shown by a maximum reading of the hot-wire ammeter in series with the antenna. This adjustment may be checked with a wavemeter. The wave length at which maximum current is obtained should be the same as the wave length for which the primary was adjusted. The wavemeter should not be coupled to the secondary of the oscillation transformer, but to a loading coil or other coil at a distance, or to the ground connection. The coupling is then made closer until two points of resonance appear. It is desirable to have a pure wave; that is, have only one resonance point. Therefore the coupling is loosened until it is certain that there is just one sharp point of resonance. If the set has a quenched gap, the coupling is kept close, and varied only enough to insure a single, sharp, wave. The radiation of maximum current at the desired wave length will not occur when the coupling is tightest, nor will it necessarily occur when the reading of the antenna ammeter is greatest. The condition for efficient transmission is that maximum energy radiation should be secured at the wave length to which the set is adjusted.

It is next necessary to adjust the generator voltage and the length of the spark gap to get maximum current in the antenna at the desired wave length, and a good clear spark tone. The field current of the alternator and the length of the spark gap are adjusted until maximum current and best tone are obtained, the wave length and coupling adjustments being kept fixed. It is often desirable to vary the coupling a little and then repeat this adjustment, since in some cases a small increase of coupling may make it possible to obtain increased antenna current without seriously affecting the sharpness of the radiated wave. For a quenched gap, the coupling adjustment required for maximum antenna current and best tone is very critical.

The first two adjustments mentioned are made for the purpose of obtaining in the circuits resonance to the radio frequency which it is desired to radiate. It is, however, also important to obtain proper tuning with respect to the low audio frequency (perhaps 60 to 1,000 cycles) generated by the alter-

nator. The audio frequency to which the circuit should be tuned to get the best tone and most satisfactory operation is not the frequency supplied by the alternator, but is some 10 per cent to 20 per cent lower than the alternator frequency. The reactances of the transformer and of the rotor of the alternator are very important in determining the audio-frequency tuning characteristics, and for a given transmitting set the transformer and alternator are usually so designed that their reactances will be of the proper magnitudes at the operating frequency. If the transformer and alternator do not have the proper reactance, it may be necessary to supply an inductance in series with the alternator field. If such a series inductance is used, its setting to a proper value constitutes a fourth adjustment of a spark set. For a further discussion of tuning to the audio frequency, see Bureau of Standards Circular 74, p. 230, and H. E. Hallborg, Proceedings Institute Radio Engineers, vol. 3, p. 107, June, 1915.

169. **Efficiency of the Set.**—To maintain good efficiency, all resistances in the circuits must be kept as low as possible. A number of suggestions for keeping resistances low were given in Section 166. It is also necessary to avoid brush discharges and arcs, to keep all connections tight, condenser plates and other parts of circuits free from dust and moisture, and antenna well insulated. Brush discharges may be reduced by eliminating sharp points or edges on conductors, or by coating the edges of metal plates with paraffin. The guy wires of the antenna should be divided into short lengths with insulators between them to reduce the flow of current in them. The inductance coils and the spark gap must be properly designed.

The efficiency may be defined as the ratio of the power radiated away as electric waves from the antenna to the power input in the transformer. The power input P in the transformer may be measured by an ordinary wattmeter. The power radiated from the antenna can be expressed in the form RI^2 where I is the current in the ammeter at the base of the antenna and R is the radiation resistance. The efficiency is then RI^2 divided by P . As explained in Section 143, the radiation resistance can not be measured directly, but can be found from the total effective antenna resistance by subtracting those resistances which give rise to heat losses.

Representative values for the efficiency of the entire set are 2 per cent to 15 per cent. The transformer efficiency may be roughly 85 per cent to 95 per cent. The closed oscillation circuit losses are very large in proportion to the power transferred, a fair value of efficiency being about 25 per cent (by careful design and adjustment using the quenched gap this may sometimes be increased to 50 per cent). The efficiency of the antenna circuit (radiated power divided by power given to the antenna) may be between 20 per cent and 2 per cent or lower, or may be made as high as 50 per cent if special pains are taken. The product of the three separate percentages gives the over-all efficiency. For an interesting table of comparative values of efficiencies see J. A. Fleming's "Wireless Telegraphist's Pocket Book," pp. 221 and 223.

170. **Calculations Required in Design.**—This section gives methods for determining the values of condensers and coils to be used in transmitting apparatus, and enables one to calculate the capacity or inductance of such condensers and coils as are commonly employed. The most important design formula is the one for wave length,

$$\lambda_m = 1884 \cdot \sqrt{CL}$$

where C is in microfarads and L in microhenries and λ in meters.

Transmitting Condensers.—The amount of capacity needed in the condenser in the closed transmitting circuit may be determined from the formula

$$C = \frac{2 \times 10^6 P}{N E_0^2} \quad (87)$$

where C is the capacity in microfarads, P is the power in watts, N is the number of condenser charges per second, and E_0 is the maximum emf. in volts. It may be seen from this that if a low voltage E_0 is used the capacity needed for a given power will be large and if a high voltage is used the capacity may be smaller. There is a large reduction of capacity with a small increase of voltage, because the voltage term is squared, therefore to avoid using unduly large condensers it is well to use as high a voltage as possible without brush discharge taking place. For instance, if the voltage were doubled, a condenser only one-fourth as large could be used for the same power. As an illustration, if it is desired to use $\frac{1}{2}$ kw. at 12,000 volts, with 1,000 sparks per second,

$$C = \frac{2 \times 10^6 \times 500}{1000 \times 144 \times 10^6} = 0.007 \text{ microfarad.}$$

Knowing the total capacity required, the number of sheets of dielectric required to make up the condenser is obtained from the formula,

$$C = 0.0885 \times \frac{1}{10^6} \times K \frac{nS}{r} \quad (88)$$

where K is the dielectric constant of the insulating material, n is the number of sheets of dielectric, S is the area of each sheet in square centimeters, τ is the thickness in centimeters, and C is the capacity in microfarads. Supposing that mica is not available, it may be required to find the number of sheets of glass required to make up the condenser of 0.007 microfarad required above. Suppose the sheets are 15 by 20 cm., 0.25 cm. thick, and the dielectric constant is 7. Substituting in the formula just given,

$$n = \frac{0.25 \times 0.007 \times 10^6}{0.0885 \times 7 \times 15 \times 20} = 9$$

Thus nine sheets of this dielectric are needed.

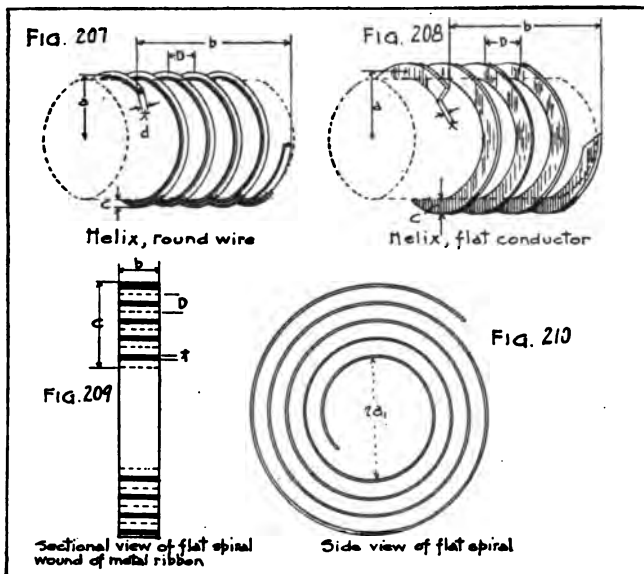

It should be noted that the higher the spark frequency N the smaller may be the condenser used to give the same power. For this reason, as well as the others previously given, it is a distinct advantage to use a high spark frequency.

When the voltage at which it is desired to operate the spark gap is so high that it will break down the particular insulation used in the condensers or cause brush discharge, the connection of four condensers, each of capacity C , as shown in Fig. 206, p. 380, will give a resultant capacity C , while subjecting each condenser to only half the full voltage.

Inductance Coils.—The principal inductance coils in a radio set are the primary and secondary of the oscillation transformer and the antenna loading coil, and the three corresponding coils of the receiving set. The three coils, oscillation primary and secondary and loading coil, are very similar. In actual practice few operators know even approximate values of the inductances; a standard form is used, depending somewhat on the size of the set, and adjustments by clips or taps enable the proper values to be used. In order to design a set the inductances of the coils are calculated and an allowance made for the small inductance in the leads and other parts of the circuit. The form usually used for coils in transmitting circuits is either the helix (single layer spaced coil) of round wire or edgewise wound strip, Figs. 207 and 208, or the flat spiral 'or pancake of bare metal ribbon, Figs. 209 and

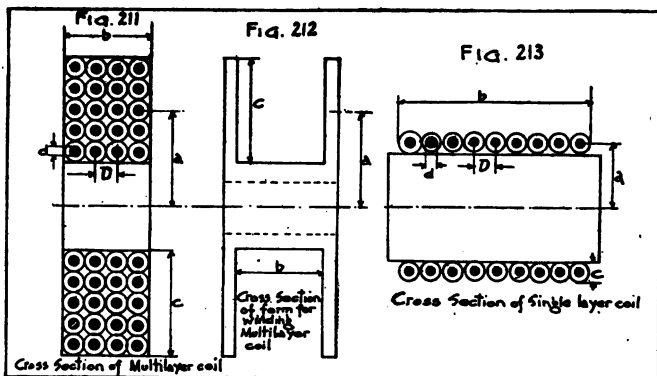

210. For wavemeters a multilayer coil is used, having wires insulated and close together, Figs. 211 and 212. For receiving coils the common form is a single layer of insulated wires, Fig. 213. The coils are supported or held together by some insulating material, and no iron is used in them.

Helix of Round Wire.—The inductance of the helical single-layer coil or solenoid of Fig. 207 is given in microhenries by

$$L = \frac{0.0395a^2n^2K}{b} \quad (89)$$

where a and b are shown in Fig. 213, a being the mean radius of the solenoid and b the total length of the solenoid; n is the number of turns of wire in the single layer; d is the diameter of the bare wire; and K is a shape factor depending upon the relative dimensions, all lengths being expressed in centimeters. A brief table of values of K is given below. In the figure, D is the pitch of the winding or the distance

between centers of adjacent wires; c is the radial thickness of the winding.

As an example, find the inductance of a solenoid having 15 turns of bare wire of diameter 0.4 cm., pitch of winding 1.1 cm., diameter of core 24 cm. In the formula $d=0.4$ cm., $D=1.1$ cm., $n=15$, $b=nD=16.5$ cm., $a=12+.2=12.2$ cm. Then with $\frac{2a}{b}=\frac{24.4}{16.5}=1.48$, K is found as 0.598. From the above formula the inductance in microhenries is given by

$$L = \frac{0.0395 \times 12.2^2 \times 15.2}{16.5} \times 0.598 = 48.0$$

If it is desired to compute the inductance more closely than a few per cent, more accurate formulas should be used as given on page 253 of Bureau of Standards Circular No. 74 and in Bureau of Standards Scientific Paper No. 169.

TABLE OF VALUES OF K .

(Shape Factor of Helical Inductance Coils.)

Diameter Length	K	Diameter Length	K	Diameter Length	K
0.00	1.000	0.70	0.761	3.50	0.394
.05	.979	0.80	.735	4.00	.365
.10	.959	0.90	.711	5.0	.320
.15	.939	1.00	.688	6.0	.285
.20	.920	1.25	.638	7.0	.258
.25	.902	1.50	.595	8.0	.237
.30	.884	1.75	.558	9.0	.219
.40	.850	2.00	.526	10.0	.203
.50	.818	2.50	.472	25.0	.105
.60	.789	3.00	.429	100.0	.035

Helix of Edgewise Wound Strip.—Refer to Fig. 208. For this case the formula is

$$L = \frac{0.0395 a^2 n^2 K}{b} - \frac{0.0126 n^2 a c}{b} \quad (90)$$

microhenries, where K is given in the table above.

As an illustration of use of the formula, a helix of 36 turns is wound with metal strip 0.635 cm. wide by 0.159 cm. thick with a winding pitch of 0.635 cm., to form a solenoid of mean diameter 25.4 cm. Here $D=0.635$ cm., $a=12.7$ cm., $c=0.635$ cm., $b=nD=36 \times 0.635=19.05$ cm. For $\frac{2a}{b}=1.333$, $K=0.623$.

Then from the above formula

$$L = \frac{0.0395 \times 12.7^2 \times 900 \times 0.623}{19.05} - \frac{0.0126 \times 900 \times 12.7 \times 0.635}{19.05}$$

$$L = 187.4 - 4.0$$

$$L = 182.5 \text{ microhenries.}$$

Flat Spiral.—See Figs. 209 and 210. The inductance is given by

$$L = 0.01257 a n^2 \times \left[2.303 \left(1 + \frac{b^2}{32a^2} + \frac{c^2}{96a^2} \right) \log_{10} \frac{8a}{d} - y_1 + \frac{c^2}{16a^2} y_2 \right] \quad (91)$$

whose $a = a_1 + \frac{1}{2}(n-1)D$; $d = \sqrt{b^2 + c^2}$; and y_1 and y_2 are shape factors given in the following table. See example below.

Shape Factors for Flat Spiral Inductance.

$\frac{b}{c}$	y_1	y_2	$\frac{b}{c}$	y_1	y_2
0	0.500	0.597	0.50	0.796	0.677
0.025	.525	.598	.55	.808	.690
.05	.549	.599	.60	.818	.702
.10	.592	.602	.65	.826	.715
.15	.631	.608	.70	.833	.729
.20	.665	.615	.75	.838	.742
.25	.695	.624	.80	.842	.756
.30	.722	.633	.85	.845	.771
.35	.745	.643	.90	.847	.786
.40	.764	.654	.95	.848	.801
.45	.782	.665	1.00	.848	.816

Illustration.—A flat spiral of 38 turns is wound with copper ribbon whose cross sectional dimensions are 0.953 cm. (3/8 in.) by 0.795 cm. (1/32 in.), the inner diameter being 10.3 cm., and the measured pitch 0.4 cm. Here $n=38$, $b=0.953$, $D=0.4$, $c=nD=38 \times 0.4=15.2$ cm.; $2a_1=10.3$ therefore $a=5.15+\frac{37}{2} \times 0.4=12.55$ cm.; $d=\sqrt{0.953^2+15.2^2}=15.23$ cm.; $\frac{8a}{d}=6.592$; $\frac{b^2}{32a^2}=0.0002$; $\frac{c^2}{96a^2}=0.0152$; $\frac{c^2}{16a^2}=0.091$; $\frac{b}{c}=0.0627$. Then from the table, $y_1=0.5604$ and $y_2=0.599$. From the above formula,

$$L = 0.01257 \times 12.55^2 \times 38^2 \times [2.303 \times 1.015 \times \log_{10} 6.592 - 0.5604 + 0.091 \times 0.599]$$

$$L = 323.3 \text{ microhenries.}$$

This is correct to $\frac{1}{2}$ of 1 per cent.

Multi-Layer Coil.—The coil is made of insulated wire closely wound as in Fig. 211. Such coils are used in wavemeters. The insulating frame on which the coil is wound has the cross section shown in Fig. 212. The inductance is given by

$$L = \frac{0.0395 a^2 n^2 K}{b} - \frac{0.0126 n^2 a c}{b} (0.693 + E)$$

where E is given by the following table:

$\frac{b}{c}$	E	$\frac{b}{c}$	E
1	0.000	12	0.289
2	.120	14	.296
3	.175	16	.302
4	.208	18	.306
5	.229	20	.310
6	.245	22	.313
7	.256	24	.316
8	.266	26	.318
9	.273	28	.320
10	.279	30	.322

As an illustration, a coil has 15 layers of insulated wire, with 15 turns to a layer, the mean radius being 5 cm. The coil is 1.5 cm. deep and 1.5 cm. in axial length. Here $a=5$, $n=225$, $b=c=1.5$. From the tables K is 0.267 and E is zero. Then the formula gives

$$L = \frac{0.03948 \times 25 \times 225^2}{1.5} \times 0.267 - \frac{0.01257 \times 225^2 \times 5 \times 1.5}{1.5} \times 0.693$$

$$L = 8887 - 2205$$

$$L = 6682 \text{ microhenries.}$$

Single Layer Coil.—Refer to Fig. 213. The inductance is computed by the formula (89). As an illustration, a coil has 400 turns of wire in a single layer, pitch of winding 0.1 cm., radius of coil out to center of wire 10 cm. Here $a=10$, $n=400$, $D=0.1$, $b=nD=40$. With $\frac{2a}{b} = \frac{20}{40} = 0.5$, K is found as 0.818.

$$L = \frac{0.03948 \times 100 \times 400^2}{40} \times 0.818 = 12920 \text{ microhenries.}$$

For any other inductance calculations see Bureau of Standards Circular 74, Sections 66 to 73, and Bureau of Standards Scientific Paper No. 169.

171. Simple Field Measurements.—On high power radio transmitting sets it is desirable to have instruments reading the current taken from the generator, the voltage of the same, the power so taken, and the frequency of the current. The four instruments, ammeter, voltmeter, wattmeter, and frequency meter, are permanently mounted on the switchboard. The measurements of the various radio quantities are explained below.

Voltage.—A simple method of measuring a voltage, either direct current or alternating current at high or low frequencies, is to determine the length of the air gap between two electrodes across which the given voltage will just cause a spark to pass. The sparking voltage depends to some extent on the humidity, the temperature and the pressure of the air, and the time of application of the spark. In the case of alternating current this method measures the maximum value of the voltage wave during a cycle. For approximate measurements this method can be considered to give results not depending on the wave form or frequency. For sine-wave alternating current the effective value of the voltage (the value indicated by an ordinary voltmeter) is, of course, the maximum value divided by 1.414. The observer should be cautioned not to attempt to change the length of the gap while the spark is passing.

For approximate measurements at voltages under 30,000, a needle gap is fairly satisfactory. The needle gap is somewhat inconvenient because results depend to some extent on the diameter and the sharpness of the needles and because the needles must be replaced after each discharge. Fig. 214 shows the maximum values of sparking voltages corresponding to various lengths of needle gaps in air at atmospheric pressure, No. 12 sharp needles being used.⁴ More reliable results can be obtained with a gap having brass spheres as terminals.⁵ Fig. 214

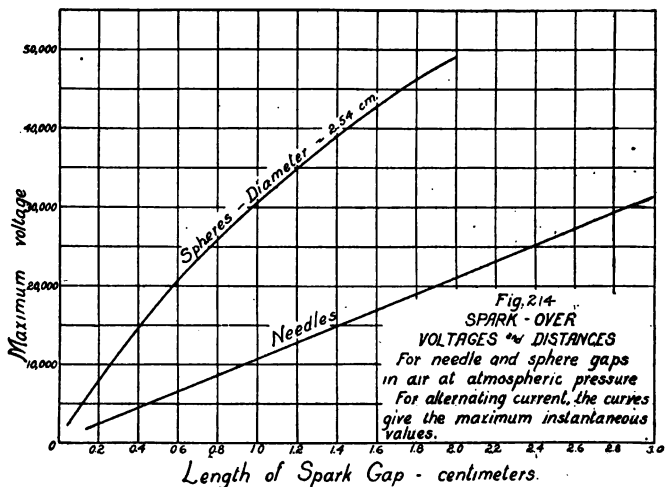

also shows for air at atmospheric pressure the maximum values of sparking voltages corresponding to various lengths of gap with terminals consisting of spheres one inch (2.54 cm.) in diameter. The results used in plotting both curves were obtained with alternating current, but will also apply to the measurement of d.c. voltages.

⁴ See H. W. Fisher, Trans. Int. El. Congress, 1904, vol. 2, p. 297; N. Campbell, Phil. Mag., 38, 214, August, 1919.

⁵ See E. A. Watson, Journal Inst. El. Eng. (London) 43, 120 (1909); J. de Kowalski, Phil. Mag., 18, 699 (1909); J. A. Fleming, Wireless Telegraphists' Pocket Book, p. 110 (London, 1915); F. W. Peek, Dielectric Phenomena in High Voltage Engineering, 2d ed., p. 88 (New York, 1920).

Current.—The principal current measurement in practice is that of the current in the antenna. A hot-wire ammeter is inserted in the lead-in or ground wire. If its reading is lower than normal, it indicates trouble in the adjustment of the apparatus, or in the grounding, and means decreased distance of transmission. In order to avoid undue interference with other stations, the ammeter current should be kept as small as will give the needed range. As has been stated before, a low resistance lamp can be used in place of the ammeter. When the closed circuit and antenna are not in resonance, the lamp burns feebly or not at all. Current measurements are also necessary in connection with some of the various measurements.

Wave Lengths.—The theory and use of the wavemeter have been discussed in Sections 112 and 168. A wavemeter placed in inductive coupling with a coil or antenna carrying radio current will show pronounced increase of current in its own coil and condenser when it is tuned to resonance with the source. The wave length is read directly from the wavemeter setting for resonance, or from a calibration curve. A receiving set can be used to measure the wave lengths of received waves if it is first standardized in terms of wave lengths. This standardization is done by the arrangement of apparatus shown in Fig. 215, where Z is a buzzer, LC a wavemeter, and A the inductance coil of the receiving circuit.

The operator listens in the telephone of the receiving set (not shown in the figure). As the wavemeter condenser knob is turned the loudest sound is heard when the wavemeter circuit is tuned to the same wave length as that for which the receiving set is adjusted. The wave length is then read from the wavemeter scale or calibration curve. Continuing in this manner, the receiving circuit can be calibrated as a wavemeter, by setting it at many different adjustments and reading the wave lengths at resonance each time. The wavemeter need never be used, after that for received waves, and the operator always knows where to tune for any wave length.

Inductance.—To find the unknown inductance L_x of a coil, a tuned source, which need not be a wavemeter, is excited by a buzzer, shown at Z in Fig. 216. A wavemeter with a coil of known inductance L is brought near, and its variable condenser adjusted to resonance at a setting C by the use of a detector

and telephone connected as shown in Fig. 216. L is then replaced by L_x and a new value of capacity C' is found for resonance. Then $LC=L_xC'$, and L_x is found as $L\frac{C}{C'}$. If the wavemeter reads directly in wave lengths, and λ is the wave length corresponding to resonance for the circuit containing L , and λ' corresponds to resonance L_x , then L_x is found as $L\left(\frac{\lambda}{\lambda'}\right)^2$. The value thus measured is the apparent inductance, which depends somewhat on the frequency of the oscillation (see Sec. 114). Values of L_x can be obtained at different frequencies of the source.

A second way of measuring inductance is by the use of a standard condenser instead of a standard coil (see Fig. 216). L_1 is connected to the standard condenser C_1 , and that circuit is set in oscillation by the buzzer Z . The wave length is measured by a wavemeter, and L_1 is computed from the relation $\lambda=1884\sqrt{CL}$, where C is in microfarads, L is in microhenries, and λ is the wave length in meters.

A better way of connecting the detector and telephones in a wavemeter circuit is what is known as the "unipolar connection," shown in Fig. 217. This method has the advantage that the decrement of the wavemeter circuit is kept low, permitting sharp tuning to resonance, and the further advantage that the wave length of the circuit can be accurately calculated from the value of L and C , which is not the case with the connection shown in Fig. 216. (See Circular 74 of the Bureau of Standards, p. 105.)

Inductance of Antennas.—The inductance of an antenna can be measured by the use of two loading coils whose inductance is known. The coils are successively connected into the antenna circuit, and the wave lengths for which the antenna is in resonance are determined. If the inductances of the coils are, respectively L_1 and L_2 , and the corresponding wave lengths are λ_1 and λ_2 , then since $\lambda_1=1884\sqrt{(L_1+L_a)C_a}$ and $\lambda_2=1884\sqrt{(L_2+L_a)C_a}$ we have the relation

$$L_a = \frac{L_2\lambda_1^2 - L_1\lambda_2^2}{\lambda_2^2 - \lambda_1^2}$$

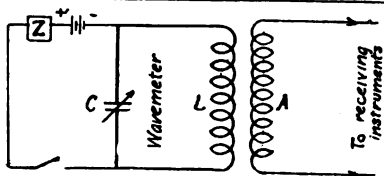

Fig 215
Wave Length Calibration
of a Receiving Set

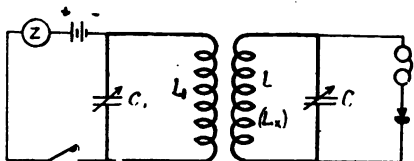

Fig 216

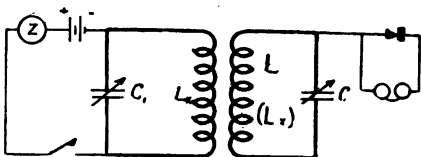

Fig 217

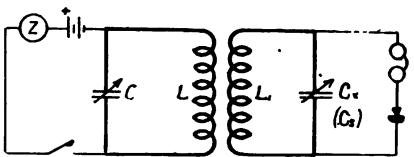

Fig 218

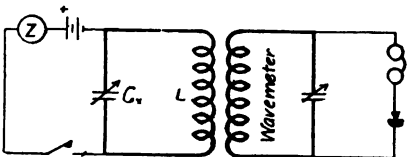

Fig 219

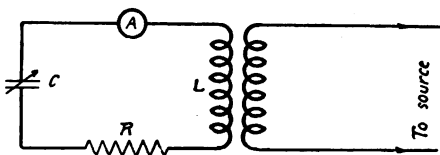

Fig 220

Capacity of Condensers.—The simplest method to measure the capacity of condensers is that of comparison with a standard variable condenser. A tuned circuit LC is excited by a buzzer, Z in Fig. 218: The unknown condenser C_x is placed in series with an inductance coil L_x and the buzzer circuit adjusted to resonance, using the detector and telephone of the circuit under test. The unknown condenser C_x is then replaced by the standard condenser C_s , which is now adjusted to resonance with the buzzer circuit. The capacity of the unknown condenser is then the same as that read on the standard.

If a standard condenser is not obtainable, the capacity of the unknown variable condenser can be found by connecting it to an inductance of known value L and exciting the circuit by a buzzer. The wave length is read on a wavemeter (Fig. 219). C_x is found from the relation $\lambda_m = 1884\sqrt{C_x L}$.

Accurate results are easily obtained by the first method described, that of comparison; but the second method is open to error because of the distributed capacity of the lead wires and the coil, and the inductance of the leads. The effect is slight if the capacities employed are large.

Capacity of Antennas.—The capacity of an antenna may be determined by either of the two methods just described for determining the capacity of condensers. The antenna and the ground form the two plates of the unknown condenser. If the inductance of the antenna has been determined by the method described above, the capacity can be calculated by substituting the value of L_a in either of the wave length equations.

$$\lambda_1 = 1884\sqrt{(L_1 + L_a)C_a}$$

or

$$\lambda_2 = 1884\sqrt{(L_2 + L_a)C_a}$$

Resistance and Decrement.—Three simple methods are available for the measurement of high-frequency resistance, (1) resistance substitution, (2) resistance variation, and (3) reactance variation. These same methods can be used for the measurement of decrement, since the resistance and decrement are connected by the simple relation $\delta = 19.7 RfC$, where R is the resistance in ohms, f is the frequency, and C is the capacity in farads at resonance which is known from the condenser

setting. Of the three methods, the first is best if a variable high-frequency resistance standard is available; the second is a good all around method, requiring resistance standards, but these need not be variable; the third requires no resistance standard, and is especially suited to measuring the decrement of a wave. In all three methods, the best results are obtained if the exciting source gives continuous or only slightly damped oscillations. In the resistance-substitution method, the resistance R to be measured is inserted in a tuned circuit with a variable condenser C and an inductance coil L coupled loosely to the source, as shown in Fig. 220. A hot-wire ammeter is inserted at A . The circuit is tuned to the source and the reading of A is noted. The resistance R is then replaced by a variable resistance standard which is adjusted until the ammeter reading is the same as it was before. The known amount of resistance inserted is the same as R .

In the resistance-variation method, the current is first read in the circuit tuned to the source, and then a known resistance is inserted in the circuit and the current is again read. If I is the current in the circuit alone, and I_1 is the current observed after adding the resistance R_x , then

$$R_x = \frac{R_s}{\frac{I}{I_1} - 1}$$

This method is particularly adaptable to the measurement of antenna resistance.

Resistance standards for radio work must be of fine wire to avoid skin effect, and must be short and straight in order to have very little inductance.

For additional information on measurements the reader may consult Circular 74 of the Bureau of Standards, and also a paper by J. H. Dellinger, The Measurement of Radio-Frequency Resistance, Phase Difference, and Decrement, published in the Proceedings of the Institute of Radio Engineers, vol. 7, pp. 27-60, February, 1919. Information regarding the measurement of antenna constants is given in Bureau of Standards Scientific papers Nos. 326 and 341. See also The Wireless Experimenter's Manual, by E. E. Bucher.

B. Apparatus for Undamped Wave Transmission.

172. Advantages of Undamped Oscillations.—Undamped oscillations are not broken up into groups like damped oscillations. Exactly similar current cycles follow one another continuously, except as they are interrupted by the sending key or subjected to variations in amplitude. The principal sources of undamped oscillations are the high-frequency alternator, the arc converter, and electron tubes. The timed spark transmitter emits waves which are only very slightly damped. (See Sec. 156.) This chapter does not take up electron tubes and their uses, these being treated in the following chapter.

For transmission over long distances, as between the United States and France, it has been found that much better results are usually obtained by the use of undamped waves. Damped waves are, however, still used for some long-distance work. Desirable characteristics in transmitting apparatus for use in long-distance work are that it should generate a "pure wave"—that is, a fundamental wave in which practically no harmonics are present—that it should provide reliable service economically, that it can be manufactured in units of large size, that it be adapted to high-speed signaling, and that it will efficiently generate a wave of considerable length. For long-distance work it is in fact essential that long wave lengths be used. (See Sec. 134.) Thus the usual wave length used by the Annapolis 500-kw. arc station is about 17,100 meters, and the usual wave length used by the New Brunswick 200-kw. high-frequency alternator station is 13,600 meters.

Principal advantages obtained by the use of undamped waves are the following: (1) Radiotelephony is made possible if a pure wave can be obtained. (2) Extremely sharp tuning is obtained, and it is possible for two near-by stations to work on wave lengths which are very close together without interfering with each other. The tuning is, in fact, so sharp that a slight change of adjustment throws a receiving set out of tune and the operator may pass over the correct tuning point by too rapid a movement of the adjusting knobs, particularly on the shorter wave lengths. (3) Since the oscillations go on continuously instead of only a small fraction of the time, as in the case of damped waves, their amplitudes need not be so great,

and hence the voltages applied to the transmitting condenser and antenna are lower. (See Secs. 116, 160.) The antenna is often the most expensive part of the transmitting station, and since the radiating power of an antenna is limited by the maximum voltage during one impulse the radiating power of a given antenna is much greater with a generator of continuous waves than with a spark transmitter. (4) Very sensitive methods of reception can be used, particularly beat reception (see Sec. 205, p. 501), which increases the range to which an undamped wave station can work. (5) With damped waves, the pitch or tone of received signals depends wholly upon the number of sparks per second at the transmitter. When the beat method is used for receiving undamped waves the receiving operator controls the tone of the received signals, and this can be varied and made as high as desired to distinguish it from strays and to suit the sensitiveness of the ear and the telephone. These advantages—freedom from interference from other stations through selective tuning, the use of high tones, and the greater freedom from strays—combine to permit a higher speed of telegraphy than could otherwise be obtained.

173. High-Frequency Alternators.—In Section 95 there has been briefly described the construction of several types of high-frequency alternators. In the United States the Alexanderson type of high-frequency alternator is the only one of practical importance, and this is the only type which we will consider in this section. As has been pointed out in Section 95, the Alexanderson alternator generates the frequency desired *directly*, and the frequency generated is directly proportional to the speed of the alternator. It is therefore necessary to have very constant speed in order to have a constant wave length, and with the regulators used with these machines a speed regulation of one-tenth of 1 per cent has been obtained, which is sufficient for practical purposes. The high-frequency alternator is adapted primarily to wave lengths longer than 10,000 meters—that is, to frequencies less than 30,000 cycles per second—and is therefore primarily of use for long-distance work. Frequencies as high as 200,000 cycles have been obtained, however, in small units. The station at New Brunswick is equipped with a 200-kw. Alexanderson alternator, which delivers 600 amperes to the antenna when working at full power.

The inductance and capacity of the antenna used with a high-frequency alternator should be of such values as to give the circuit the same natural frequency as the frequency generated by the alternator at the speed at which it is to be run. This tuning of the antenna circuit is accomplished by adjusting the antenna loading coil until maximum antenna current is obtained. At high-power stations equipped with alternators the multiple tuned antenna is often used. (See Sec. 143.)

Fig. 221 shows completely assembled, with the induction motor which drives it, a 200-kw. Alexanderson alternator of the type

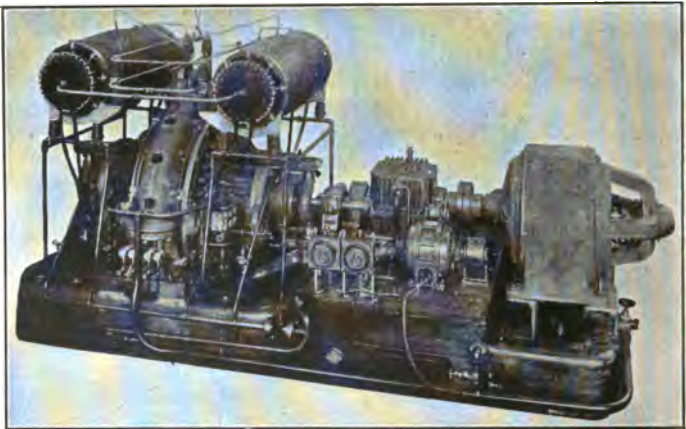

FIG. 221.—200 kw. Alexanderson alternator.

used at New Brunswick, N. J., Tuckerton, N. J., and Marion, Mass. This type of machine is built to operate at wave lengths from 11,500 to 20,000 meters. At New Brunswick the normal operating wave length is 13,600 meters, which corresponds to a frequency of about 22,100 cycles per second. The New Brunswick station is operated by remote control, using a land wire from an office in New York City, about thirty miles away. Plans have been completed for the construction of a very large station of this type at Port Jefferson, Long Island, about 60 miles from New York. This station when complete will have six separate alternators and six antennas. One alternator rated at about 200 kw. was placed in service in November,

1921. The use of the alternator secures the advantages of undamped waves, which are considered in the preceding section. The alternator has several advantages over the arc converter, chief of which is the freedom of the alternator from harmonics. The operating characteristics of large arcs make their use for radio telephony not practicable in their present state of development. The first cost of the alternator, however, is much higher than an arc of the same power. The arc has the advantage that it is more rugged, more simple, and when out of order can usually be quickly repaired by the regular station force, while if a high-frequency alternator is seriously disabled it is usually necessary to secure a skilled man from the factory to make repairs. It is possible to use the high-frequency alternator with the simplest possible kind of a circuit, simply connecting one side of the alternator to ground and the other side to the antenna through a variable inductance. In actual practice, however, the circuits are more complicated. Because of the large currents necessary for high-power stations, it is desirable to have the signaling controlled by a method which does not make it necessary to break the full current. This is accomplished by the use of a device called a "magnetic amplifier," which is a variable impedance connected in shunt with the external circuit of the alternator, but physically is of the nature of an oil-cooled transformer. The magnetic amplifier has been described by Alexanderson in a paper published in the Proceedings of the Institute of Radio Engineers, April, 1916, vol. 4, p. 101, and in A. N. Goldsmith, Radio Telephony, p. 192. The iron core is made of thin laminations and is so designed that the magnetic permeability of the iron core can be varied by causing magnetic saturation by an auxiliary-control circuit. This auxiliary circuit may be actuated by the signaling key in the case of radiotelegraphy, or by the output of a microphone in the case of radiotelephony. With the circuit now used the controlling current is in an entirely separate circuit from the radio-frequency current, and a control current of a few amperes will control an antenna current of several hundred amperes. When the sending key is open the magnetic amplifier short circuits the alternator through circuits including condensers and detunes the antenna, thereby reducing the antenna current to a negligible value. When the sending key is closed the output of

the alternator is delivered to the antenna at the working wave length. The magnetic amplifier has been successfully used experimentally for transmitting at speeds of 500 words per minute. When the alternator is used for radiotelephony the magnetic amplifier is used for varying the alternator output in accordance with the wave form of the speech which is being transmitted. The use of small magnetic modulators for controlling currents of five amperes or less in electron tube radiotelephone sets is mentioned in Section 207, page 518. It is not possible in this book to describe the operation of the Alexanderson alternator in detail, and for further information the reader is referred to the papers by E. F. W. Alexanderson, Proceedings American Institute Electrical Engineers, vol. 38, p. 1077, October, 1919; Proceedings Institute Radio Engineers, vol. 8, p. 263, August, 1920; General Electric Review, vol. 23, p. 794, October, 1920; and to a paper by E. E. Bucher, General Electric Review, vol. 23, p. 813, October, 1920.

174. **Arc Converters.**—*Introduction.*—At the present time the arc is the most widely used type of transmitting apparatus for high-power, long-distance work. It is estimated that the arc is now responsible for upward of 80 per cent of all the energy actually radiated into space for radio purposes during a given time, leaving amateur stations out of consideration. The advantages of undamped waves for transmission over long distances have been pointed out in Section 172, and the arc is a source of such undamped oscillations. Its chief advantages over the high-frequency alternator described in Section 173 are that its initial cost is much lower for a given power, that it is a much more rugged device than the high-frequency alternator and does not require the extreme accuracy in machine work required for the alternator, and that it is not so critically sensitive to small changes in operating conditions as the alternator. The speed of the high-frequency alternator must be maintained almost exactly constant to secure satisfactory operation and a constant wave length. Electron tube transmitting sets have usually been constructed to cover only comparatively short distances and have been rated at a few kilowatts. Recently, however, tube transmitting sets of higher power have been constructed. A tube transmitter at Clifden, Ireland, is in use for transatlantic work, and is capable of putting over 200 am-

peres into the antenna. Experimental investigations of arc transmitters are usually conducted only at stations where such sets are installed and not at all electrical laboratories, because of the comparatively high initial cost of the arc compared with usual laboratory equipment. For this reason the arc has been studied by a much smaller number of investigators than some other radio devices, such as the tube, which are at present really of less importance than the arc in high-power, long-distance work.

The new radio station at Bordeaux, France, constructed by the United States Navy and at the present time the most powerful radio station in the world, is equipped with a 1000-kw. arc. The most powerful radio station in the United States—the Naval Radio Station at Annapolis—is equipped with a 500-kw. arc. Duplicate arcs are installed at both of these stations to provide for continuous operation in case of breakdown. All the capital battleships and many other ships of the United States Navy and all important shore stations controlled by the United States Navy are equipped with arc transmitters as primary equipment. The arc equipment of naval shore stations varies in power from 2 kw. for small stations to 500 kw. for Annapolis. The Signal Corps is operating a considerable number of arc stations at various points in the United States and its possessions and is installing additional arc equipment. A large number of ships owned by the United States Shipping Board are being equipped with arc transmitters. Arc transmitters are also extensively used abroad. Small arcs, in sizes as low as 2 kw., are in commercial use. For arc converters of medium power the initial cost can be very roughly stated to be something like \$1,000 per kilowatt. About six years ago the largest arc in use was rated at about 30 kw., and much of the development of the arc to its present state, when 1000-kw. arcs are constructed, has occurred during the past four years. At the present time arcs are not used commercially in radiotelephony, as has been stated above, but improvements may make this possible in the future. It is customary to rate arc transmitting according to their d.c. power input. One operating difficulty with the arc transmitter is that it often generates, in addition to the fundamental wave, harmonics, that is, waves having frequencies which are multiples of the funda-

mental frequency. Besides the harmonics, arc transmitters also often generate irregular intermediate frequencies, called "mush," the strongest of which frequencies fringe the fundamental and harmonics. The harmonics and the "mush" often cause interference on shorter wave lengths, particularly at near-by stations.

175. The Characteristics of the Direct-Current Electric Arc.—If between two pieces of conducting material, such as two carbon rods, separated in air by a short distance, there is applied a considerable d.c. voltage, an arc will be formed between the carbon electrodes and will continue if a sufficient voltage is maintained. The voltage required to maintain the arc will be much less than that required to start the arc cold, and, in fact, an arc is not usually started with the electrodes separated. If we study the behavior of such an arc and measure the current corresponding to various d.c. voltages maintained at the terminals of an arc already formed, we will obtain a curve for voltage plotted against current like that shown in Fig. 223. This curve shows that as the applied voltage is increased the current through the arc decreases. The corresponding characteristic curve of an ordinary ohmic resistance would be a straight line sloping upward to the right from the origin. This behavior of the arc, exactly opposite to what occurs when the voltage applied to an ordinary conductor is increased, is described by saying that the arc has a "falling characteristic," or that it is a variable resistance, which increases as the applied voltage increases. It is this "falling characteristic" of the arc that makes possible its use as a generator of undamped oscillations.

When the arc is used to generate undamped oscillations the current which flows at any instant between the arc electrodes is the resultant of the steady current supplied by the d.c. generator and the current in the condenser shunt circuit, as described in the next section. In the first two cases described in the next section, which can properly be considered to be arc discharges, the current between the electrodes always flows in the same direction, but may vary in magnitude.

The statement is sometimes made that an arc is a "negative resistance"; this statement can not be considered correct. The current in an arc passes from the electrode of higher voltage to

the electrode of lower voltage, and the resistance of the arc should therefore be considered to be positive, since in this respect it behaves as any ordinary resistance. If for some reason the current through the arc falls to zero, the voltage will rise only to the value required to start the arc again, which is called the "ignition voltage." If, while an arc exists the voltage is raised sufficiently, the current will decrease until the arc is extinguished; this value of the voltage is called the "extinction voltage," and is less than the ignition voltage. If

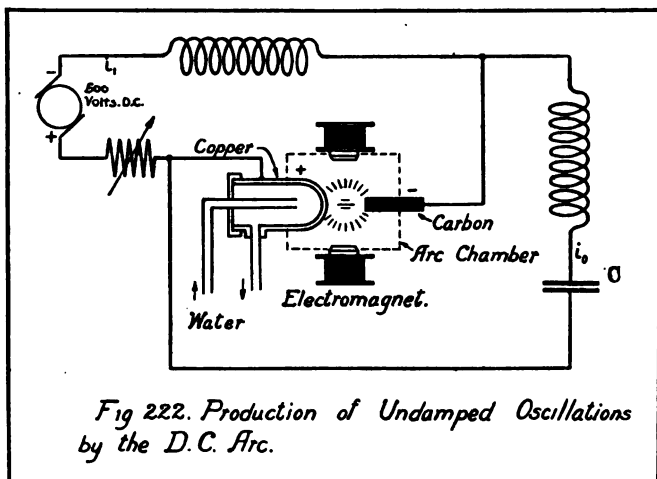

Fig 222. Production of Undamped Oscillations by the D.C. Arc.

a pulsating d.c. voltage is applied to the arc, the a.c. component of the current will be 180° out of phase with the a.c. component of voltage.

In practice, an arc is usually originally started by striking the two electrodes together and then immediately separating them, instead of applying an initial voltage high enough to start the arc in the cold gap. Arcs usually operate on voltages of about 500 to 600. The spark occurring when the contact between the electrodes is broken volatilizes the electrode and it becomes incandescent. In passing between the arc terminals the current is carried by "ions." These ions are molecules of air or other

gas which may be present in the arc gap which have acquired an electric charge because of the intense electric field existing between the arc terminals (See *Electrons*, Sec. 6). Particles of the electrode may also break off in the intense heat and assist in carrying the current across the gap. If the applied voltage is reduced to zero, the current will cease and the ions will lose their electric charge. When the arc is first started, the full current is not immediately established; there is a delay of a small fractional part of a second during which time ions are being formed in the gap in sufficient numbers to carry the full current. If the arc has been previously extinguished only a short time before, there will still be present in the gap a number of ions which have not yet lost their charges, and therefore a shorter time will be required to build up the full current. If it is desired to make the arc sensitive to changes in applied voltage, it is important to make provision for rapidly "deionizing" the arc gap. Methods for accomplishing this deionization are described below.

In general, the conduction of electricity through any gas is by means of ionization, and, in general, gaseous conductors have a "falling characteristic."

An arc chamber should never be opened after the arc has been in operation until ample time has been allowed for the carbon to cool. If air is admitted it may form an explosive mixture with the hydrogen which is used in the chamber, which will be ignited by the hot carbon.

176. **Production of Continuous Oscillations by the Arc.**—In about 1900 it was discovered by Duddell that, if across the terminals of a d.c. arc there were connected in series an inductance and a capacity of suitable values, the arc would emit a musical note, due to continuous variations in the current through the arc. The connections for such an arc are shown in Fig. 222.

In discussing the oscillations in arc circuits it is convenient to recognize three cases, depending on the relative values of the current in the condenser shunt circuit (i_0 , Fig. 222), and the steady current supplied from the d.c. generator (i_1 , Fig. 222).

(a) The maximum instantaneous value of the oscillatory current i_0 in the condenser circuit may be so much less than the steady d.c. current i_1 , that the arc is not extinguished at any

moment, but burns continuously. This is the case of the musical arc first described by Duddell, and is of no practical importance in present types of arc transmitters for radio communication. The oscillations generated are undamped but feeble.

(b) The discharge current i_0 from the condenser may be large enough to extinguish the arc at an instant when i_0 is near its maximum value but not large enough to start an arc again in the direction opposite to that in which the supply direct current is flowing. This is the case of the Poulsen arc, and is the case usually met in practice with arc transmitters. The oscillations generated are undamped and under proper conditions have large energy content.

(c) The oscillating current i_0 , after extinguishing the arc, may start an arc in the direction opposite to the direction of the steady current i_1 . In such a case it is said that reignition is present. Such oscillations are produced by the quenched spark gap, with the ordinary spark gap, described in Section 154 as an extreme case. The oscillations of type (c) are damped.

In the case of an oscillatory discharge in a circuit including an ionized gap, the distinction between the terms "arc" and "spark" is not altogether clearly drawn. In the case of oscillations of types (a) and (b) just mentioned, the term "arc" is applied. In the case of type (c) oscillations, there may be a question as to the characteristics which require the use of the term "spark." If the periods during which the current flows through the gap are separated by comparatively long intervals when no current flows, it is usual to call the discharge a spark. If for some purpose it is desired to know just what are the characteristics of the discharge in a given circuit, the wave forms of the current and voltage of the gap should be obtained with a high-frequency oscillograph. It is usually said that the conduction in an arc is mostly by ionization.

While the theoretical distinction between an arc discharge and a spark discharge requires precise consideration, the practical forms of spark apparatus and arc apparatus are usually quite different, and the two systems of communication require the separate consideration which has been given to them in this book. As has been stated in Section 156, in discussing the operation of a spark gap, when a spark gap is operating nor-

mally there is a bluish-white snap which is easily distinguished from the yellowish color and comparatively quiet operation of an arc discharge.

For the production of high-frequency undamped waves for use in radio communication, the type (b) oscillations are the

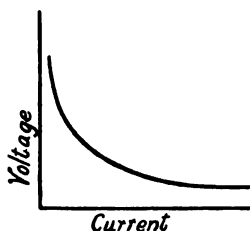

Fig. 223. Current-Voltage Characteristic of the D.C. Arc.

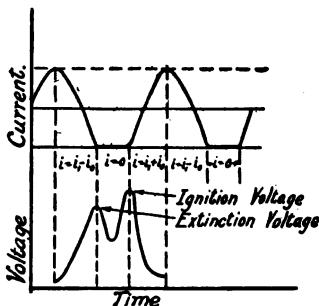

Fig. 224. Current and Voltage Waves of the Oscillating Arc.

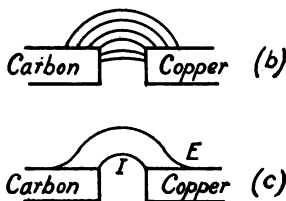
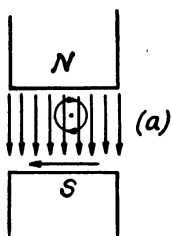

Fig. 225 Action of the Magnetic Field on the Arc Flame.

only ones of importance, and we shall omit further reference to types (a) and (c).

Let us consider the operation of an arc transmitter when the circuit is so arranged that the oscillations of type (b) are generated. To the terminals of the arc there is applied a d.c.

voltage, which is often about 500 volts, but may vary from 200 to 1200 volts according to the size of the arc. (Fig. 222.) First, suppose that the arc is burning steadily with the shunt circuit disconnected which includes the condenser and inductance. The large inductances in the generator supply line will tend to maintain constant the *current* supplied by the generator, even if the instantaneous voltage across the arc terminals varies. These inductances should have low resistance and low distributed capacity. If now the shunt circuit is connected, the condenser C begins charging with the lower plate of the condenser as shown in Fig. 222 positive, and draws current away from the arc, since the current supplied by the generator can not increase suddenly. As the current through the arc decreases, the potential difference of the arc increases because of the falling characteristic (Fig. 223) and helps the charging. The charging continues until the counter emf. of the condenser equals that applied from the d.c. source. As the charging nears its end, the charging current becomes gradually less, and the current through the arc increases to its normal value, with a corresponding drop in the voltage. The lowering of the voltage across the terminals of the arc permits the condenser to discharge, and the effect of the inductance in the circuit tends to keep the current flowing, and charges are accumulated on the condenser plates having signs opposite to those which first existed, so that the upper plate of C in Fig. 222 has a positive charge. As this charge with opposite signs now nears its end, the charging current to the right through the arc to the negative side becomes gradually less, and the arc current decreases, causing the voltage to rise. From Fig. 222 it is seen that the rise of d.c. voltage is such as to attempt to charge the lower plate of C positively, and that the positive charge on the upper plate begins at once to come back, going to the left through the arc and decreasing the current. There is a consequent further rise of voltage (Fig. 223), which is in a direction to assist first the condenser discharge, and then the recharge in the opposite direction. The action now begins all over again, and thus continuous oscillations take place through the circuit.

The original development of practical forms of arc for the generation of oscillations of type (b) is largely due to Poulsen, and we shall consider the Poulsen arcs as now in use.

177. **Construction of Arc Converters.**—The apparatus generally used for the generation and transmission of radio signals by means of the arc consists of:

A source of direct current of suitable voltage.

An arc converter, often called simply an arc.

An inductance for loading the antenna.

An antenna and ground system.

A signaling device.

Auxiliary and control apparatus.

The arc "converter" is so called because it converts the power supplied by the d.c. generator into high-frequency undamped alternating current.

The Poulsen arc converter, as manufactured by the Federal Telegraph Co., consists of one rotating carbon electrode and one copper electrode burning in an atmosphere of hydrogen or a gas containing hydrogen in the presence of a strong magnetic field. The copper electrode, or anode, is connected to the positive side of the d.c. supply and is of hollow construction, so that it may be cooled by water circulation. The electrodes are contained in a chamber usually made of bronze. This chamber is called the "arc chamber," and is often cooled by water circulation.

Fig. 226 shows a 100-kw. arc converter of the open magnetic circuit type, with the case removed, and with the various parts marked. Fig. 227 shows the interior of a 2-kw. arc of one type used on the ships of the United States Shipping Board, with the upper portion tilted back.

Both the copper anode and the carbon cathode require renewal from time to time. The anode may not require renewal for a considerable length of time; its life is greatly lengthened by proper cooling and the use of pure water in the circulating system. The carbon cathode will usually serve for about 24 hours' continuous burning. The sizes of the carbons for a few arcs are, for a 2-kw. arc, diameter $\frac{1}{2}$ inch, length 8 inches; for a 5-kw. and other medium-sized arcs, diameter $\frac{3}{4}$ inch, length 10 inches; for arcs larger than 100 kw., diameter $1\frac{1}{2}$ inches, length 12 inches. The rate of consumption of the carbon depends on the chemical composition of the gas in the arc chamber.

The carbon electrode is so mounted that it can be screwed in and out for the purpose of striking and adjusting the arc. The

length of the arc flame is adjusted by moving the carbon electrode to secure maximum antenna current.

Practical Operating Characteristics.—When an arc transmitter is properly adjusted for operation, the antenna current

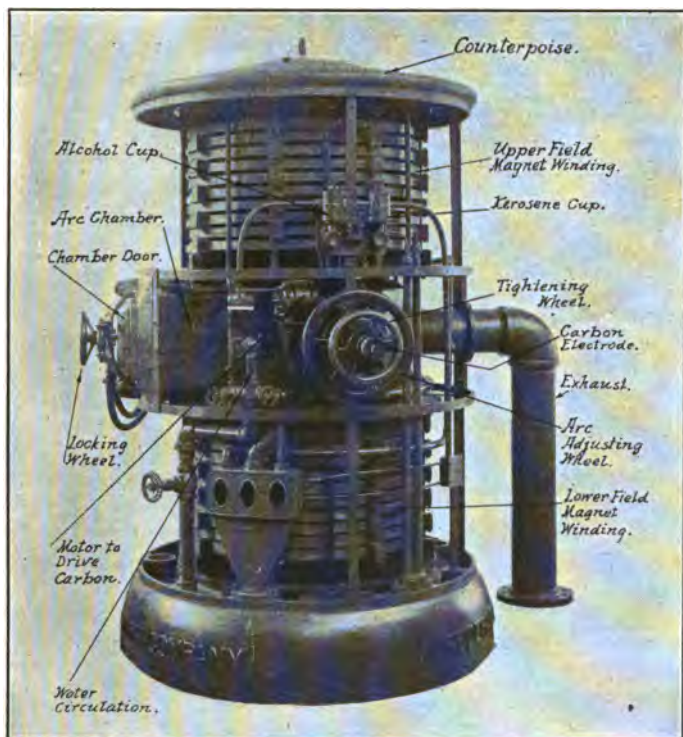

FIG. 226.—100-kw. Federal arc converter, with casing removed.

is 0.707 of the d.c. current supplied to the arc. Under these conditions, it is not necessary to place an ammeter in the antenna circuit to determine the antenna current. It has been found that for arcs rated from 15 kw. to 100 kw. the antenna current is, very closely, one ampere per kilowatt of rating when the arc is properly adjusted for operation. The efficiency of an

arc in converting d.c. power into high-frequency oscillations seldom exceeds 50 per cent; the remainder of the power supplied is largely dissipated in the arc chamber in the form of heat, and provision must be made for conducting the heat away and for preventing excessive temperatures in the arc chamber.

If an arc could be adjusted so that the voltage wave and the current wave were sine waves, the effective value of the alter-

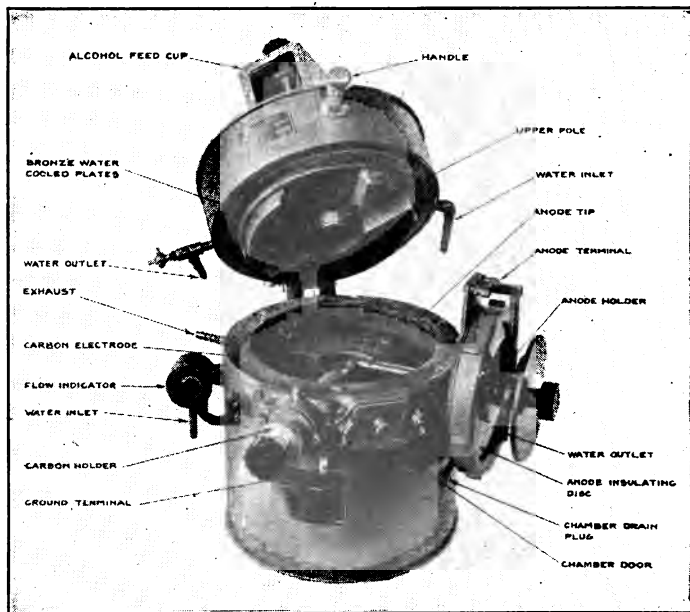

FIG. 227.—Interior of 2-kw. Federal arc converter.

nating current generated by the arc would be 0.707 of the direct current supplied, and the effective value of the a. c. voltage generated by the arc would be 0.707 of the d. c. voltage supplied. Hence, under these conditions, the a. c. power output of the arc would be 50 per cent of the d. c. power supplied to the arc proper. In considering the power supplied to the arc proper, the power supplied to the magnet windings and other

accessory apparatus should not be included. In practice, however, the wave forms of the arc are not sine waves, but are distorted, and the efficiency of conversion may differ from 50 per cent. With some kinds of distortion it might be possible to have the efficiency of conversion exceed 50 per cent, but the existence of such distortion is not a desirable operating condition.

It has been observed at many arc transmitting stations that the maximum antenna current is obtained when transmitting at a wave length which is, roughly, about three times the natural wave length of the antenna alone. Up to this wave length an increase of wave length brought about by increasing the loading inductance will, in general, result in an increased antenna current.

It has already been pointed out (Sec. 175) that it is important to provide means for rapidly deionizing the gap. Some of the means for securing this result are: the use of a strong magnetic field, or "magnetic blow-out," which removes ions from the immediate vicinity of the arc gap; the use of an anode made of copper, containing a channel through which water circulates; the use in the arc chamber of hydrogen or hydrocarbon gas having similar properties.

Magnetic Field.—Two powerful electromagnets are usually connected in series and placed in a position such that the magnetic field set up between them is *transverse* (i. e., at right angles) to the flow of the ions across the arc. A stream of ions flowing in a straight line corresponds to the flow of a current in a straight conductor, and, as has been pointed out in Sections 4 and 97, such a conductor in a magnetic field is acted upon by a force which tends to move it from the stronger field to the weaker field. (Fig. 225a.) By the action of the magnetic field, therefore, the arc flame is quickly blown to one side of the gap so far that most of the discharge takes place on the side rather than the tips of the electrodes, and under the further action of the field the flame path reaches such a length that the arc is extinguished. The path of the flame on ignition is simply from tip to tip of electrode, as shown at *I*, Fig. 225c, instead of the longer path marked *E* in Fig. 225c, which is the flame path at the moment of extinction. This difference in length of flame path is the reason for the fact that in commercial arc equip-

ment the ignition voltage is not very much greater than the extinction voltage. Any ions which may be emitted by the incandescent electrodes during the intervals when no arc is passing will also be removed by the magnetic blow-out. The magnets used in high-power arcs are very large; the magnets of a 500-kw. arc weigh about 65 tons. The strength of the magnetic field which must be supplied to have a given arc operate properly depends on the wave length and the magnitude of the radio-frequency current, the rate at which ions are formed, and what other means are provided for deionization. In an ordinary type of 100-kw. arc, designed for operation over a wide range of wave lengths, it is necessary to supply a magnetic field having a flux density from 2,000 to 10,000 lines per square centimeter. In some arc converters flux densities as high as 15,000 lines per square centimeter may be used. In general there is a best flux density for each wave length. If an arc is to operate on only one wave length, instead of over a considerable range of wave lengths, a more efficient design can be made. Arc converters designed to supply short wave lengths, such as 1,000 meters, require the most powerful magnetic fields. At wave lengths of less than 1,000 meters the proper delonization of the gap requires a magnetic field so strong as not to be practicable. With the usual type of signaling apparatus, clear tones are not obtained with arcs operated below 1,000 meters, but if a chopper is used to break up the arc oscillations into groups of audible frequencies the tone on short wave lengths will be much improved.

The 500 kw. arc converters at Annapolis are suitable for operation at wave lengths from 6,000 to 20,000 meters at the full-load radio-frequency current of 350 amperes.

Electrodes.—The advantage of the use of copper as the material for the positive electrode arises from the fact that copper has a very high heat conductivity, and, consequently, conducts heat away from the gap rapidly which aids in reducing the number of ions present in the gap. The cooling of the copper anode by a water-circulation system has the same purpose—to reduce the temperature of the gap. Practical considerations require that the cooling water should be very pure. The use of salt water will short-circuit the arc, since the water practically always flows through pipes which are connected to

the ground, and current will flow directly from the copper anode through the salt water to the ground, instead of across the arc to the carbon cathode which is connected to the ground. In order to improve the regularity of the operation of the arc the carbon electrode is rotated about its axis about once a minute. A recent improvement in arc design consists in the addition of a copper ring around each electrode. The eddy currents induced in the copper rings so modify the magnetic field as to keep the flame from creeping back to the pole pieces of the magnets and injuring them. These rings permit the use of a shorter air gap between the pole pieces.

Use of Hydrogen-in Arc Chamber.—The presence of hydrogen in the arc chamber assists in rapid deionization, because hydrogen is a very light gas and diffuses very rapidly into the space outside the gap proper, carrying ions with it. The denser the gas used in the arc chamber the greater is the strength of magnetic field required for proper deionization. Further, hydrogen itself has a high heat conductivity and aids in conducting heat away from the gap. Other advantages in the use of hydrogen are that the presence of hydrogen minimizes the oxidation of the metal parts of the arc chamber and that an arc will start for a given distance between electrodes at a lower voltage in hydrogen than in air. This latter property makes it possible, as the electrodes are consumed, to obtain greater constancy in the wave length and the intensity of the oscillations of an arc by the use of hydrogen, since a longer gap can be used.

The hydrogen may be supplied as a gas from cylinders. It is common practice, however, especially aboard ships, to slowly drop into the arc chamber alcohol or kerosene, which are volatilized by the heat of the arc, yielding hydrogen. A disadvantage is that considerable soot is deposited throughout the arc chamber. At shore stations illuminating gas is sometimes used, since this has a considerable hydrogen content, but this also results in the deposit of considerable soot.

Arc Transmitter Circuits.—It is general practice in the United States at present to connect the copper anode directly to the antenna through a loading coil; this practice is largely due to commercial reasons involving patent rights. This circuit gives best results with antennas of large capacity using large in-

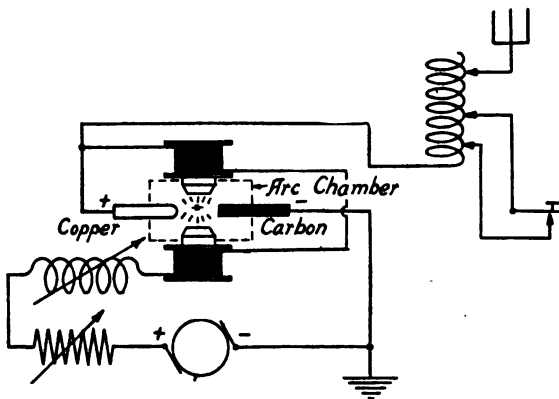

Fig.228 Circuit for Arc Transmitter with Direct Antenna Connection and Signaling Circuit for Compensation Method.

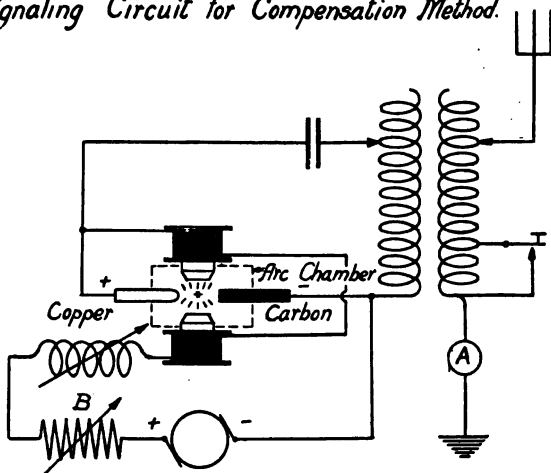

Fig.229 Circuit for Arc Transmitter with Coupled Antenna Circuit.

ductances in series with the antenna. The connections of a typical arc transmitter of American manufacture are shown in Fig. 228. In some types of arcs of European manufacture the antenna circuit is coupled as shown in Fig. 229. The antenna loading coils are usually wound with stranded high-frequency conductor to minimize the high-frequency resistance. (See Sec. 117.)

Small arc transmitters are often provided with a "chopper" to interrupt the radio-frequency oscillations at an audio frequency. The use of the chopper permits simple detector reception, and on short wave lengths where the arc operates somewhat irregularly this improves the tone of the received signal. There are several methods for connecting the chopper. In small arcs the chopper may be connected directly in the antenna circuit and shunted by a condenser of suitable capacity. Another method is to connect the chopper to a few turns coupled to the antenna circuit, which causes a slight variation in the emitted wave lengths when the chopper contact is closed. The use of the chopper is discussed in connection with electron tube transmitting sets in Section 211, page 529.

178. Signaling Methods.—For the purpose of controlling the output of an arc transmitter, the key can not be placed directly in the primary circuit, as can be done in spark systems, because if the primary circuit were broken by the key for an appreciable length of time the arc would be extinguished and would not reignite until the electrodes were again brought into contact and separated. Signaling has usually been accomplished by wave-length variation, the closing of the signaling key changing the constants of the transmitter circuit to an extent sufficient to cause a small change of the emitted wave length. Other methods of signaling are described below.

Compensation-Wave Method.—In the *compensation-wave method* of signaling two wave lengths are emitted. The receiving station to which the arc is transmitting tunes to the wave length emitted by the arc when the key is closed, which wave is called the "working wave." When the key is open the arc emits a wave length from about 1 to 5 per cent greater or from 1 to 5 per cent less than the "working wave." The wave emitted when the key is open is called the "compensation wave," or "back wave." If a receiving station is tuned

to the compensation wave it will receive only the intervals between the dots and dashes. If the compensation wave is too close to the working wave confusion will result. In arcs up to about 70 kw. the compensation method is usually used by short-circuiting by the signaling key a few turns of the inductance in series with the antenna; the arc emits a shorter wave length when the key is closed. (Fig. 228.) In larger arcs an inductance of a few turns is coupled to the inductance in series with the antenna, and the closing of the key short-circuits this coupled inductance. When the key is closed the effective inductance in series with the antenna is reduced (see transformers, Sec. 58, page 131), and hence the working wave is shorter than the compensation wave. It is, of course, possible to so adjust the connections of the key that the coupled inductance will be short-circuited only when the key is up, which will result in interchanging the working wave and the compensation wave, and the latter will be shorter. The compensation wave is sometimes called the "spacing wave."

The compensation-wave method of signaling has the serious objection that two waves are radiated, somewhat separated in length, and that therefore an arc station which has a compensation wave interferes over a much wider band of wave lengths than a station which radiates a single wave. One of the principal objects of using undamped waves for communication is to restrict each station to a narrow band of wave lengths, and this the compensation method fails to accomplish. It is probable that the use of the compensation wave will be discontinued within a few years.

Uniwave Methods.—Recently there has been developed a method of signaling called the "uniwave" method, or "one-wave" or "single-wave" method. This method involves the radiation of a single wave from the antenna. There are two principal ways of accomplishing this result—the "ignition" method in which the arc is extinguished and reignited with each dot and dash, and the absorption method, in which two waves are generated, but the "back" wave is absorbed in an auxiliary circuit.

Ignition Method.—One form of the ignition method uses an "ignition key." The ignition key consists of a solid metal rod introduced inside of the arc chamber. This rod is usually called the "striker." One end of this rod is caused to make or break

contact with an electrode connected to the positive side of the arc. The rod is connected through a suitable resistance to the negative side of the d.c. generator supplying power to the arc. The in-and-out radial motion of the striker is controlled by an electromagnet. When the signaling key is up, the striker makes contact with the positive electrode, thus short-circuiting the usual current path between the electrodes through the incandescent arc. In this position of the striker the d.c. current from the generator goes to the positive electrode of the arc, then across the striker through the striker series resistance, and back to the negative side of the generator. When the striker magnet is energized by closing the signaling key in the magnet circuit, the striker is withdrawn from contact with the anode, producing a small arc between the striker and the anode. This small arc reignites the regular arc between the anode and the cathode. The striker will successfully operate in this manner only when the arc is hot. To start the arc when cold, it is necessary to start oscillations in the usual manner. Other "ignition" methods have been described for extinguishing the arc without the use of the striker inside the arc chamber by short-circuiting the arc through an external circuit containing resistance, or aluminum electrolytic cells, and employing auxiliary circuits to expedite reignition.

The ignition key will give fairly satisfactory results on small arcs, such as 2 kw. or 5 kw. It is not as yet satisfactory for larger arcs because the heavy currents required rapidly consume the striker.

Absorption Method.—In both the compensation-wave method and the absorption method of signaling the radio-frequency output of the arc converter is maintained practically constant from instant to instant. In the compensation-wave method the compensation wave is radiated from the antenna. In the absorption method or "back-shunt" method the compensation wave does not reach the antenna, but is absorbed in an additional oscillating circuit, and only a single wave length is radiated by the antenna. The auxiliary absorption circuit, or "tank" circuit, comprises inductance, capacity, and resistance. (See Fig. 229-A.) The relay key used for signaling has a front and back contact—that is, it is a single-pole double-throw switch. One side of the absorption circuit is permanently connected to the negative electrode of the arc, which is

grounded, and the other side of the absorption circuit is connected to the back contact of the relay key. The middle contact of the signaling key is connected direct to the positive electrode of the arc, and the front contact of the key is connected to the antenna. When the key is depressed the arc circuit is connected to the antenna, and radiation occurs. When the key is up and the back contact of the key is closed, the positive electrode of the arc is connected to the absorption circuit to which the entire output of the arc is delivered, so that no wave is radiated by the antenna. The signaling key is so designed that the back contact is not broken until after the front contact is closed, so that during signaling there are

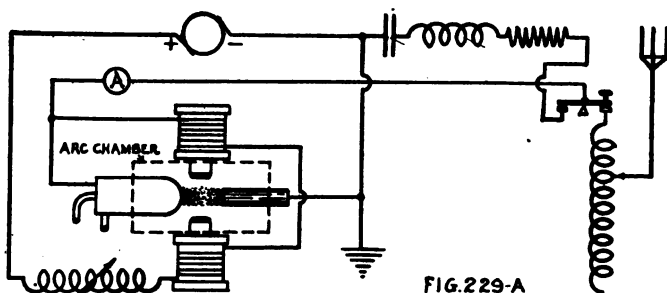

FIG. 229-A

CIRCUIT FOR ARC TRANSMITTER WITH DIRECT ANTENNA CONNECTION,
FOR ABSORPTION METHOD OF SIGNALING.

instants when the arc is connected both to the antenna and to the absorption circuit. The arc would be extinguished if entirely disconnected from both circuits.

The capacity, resistance and inductance of the absorption circuit are adjusted until the same current is delivered by the arc when it is connected to the absorption circuit as when the arc is connected to the antenna. The adjustment of the capacity, resistance, and inductance of the absorption circuit for satisfactory operation is not at all critical. The wave length generated when the arc is connected to the absorption circuit may be only one-half the wave length generated when the arc is connected to the antenna. When applied to medium and high power arcs the flow of the current to antenna or absorption circuit is controlled by impedance variations without

breaking the antenna current at the relay. The absorption method of signaling is in very successful operation at a number of semi-high-power arc stations, and is being developed for use at the larger stations. One disadvantage of the absorption method is that when the signaling key is up and the arc is connected to the absorption circuit sufficient power is radiated by the absorption circuit to affect the receiving apparatus in the same station, so that it is not possible to receive signals while the arc is causing oscillations in the absorption circuit. The ignition key method does not possess this defect, since the arc is not generating oscillations when the signaling key is up. Detailed information regarding the absorption method is given in a paper by W. A. Eaton, *Electric Journal*, vol. 18, p. 114, April, 1921.

For further information concerning the arc converter, the reader may consult the following: E. W. Stone, *Elements of Radiotelegraphy*; W. H. Eccles, *Wireless Telegraphy and Telephony*; J. A. Fleming, *Principles of Electric Wave Telegraphy*; *Manual of Federal Arc Radio Transmitters*, published by the Federal Telegraph Co. (describes 2-kw. and 5-kw. converters); P. O. Pedersen, *Proceedings of the Institute of Radio Engineers*, vol. 5, p. 255, August, 1917; L. F. Fuller, *Proceedings of the Institute of Radio Engineers*, vol. 7, p. 449, October, 1919; *The Elwell Arc Generator*, *Electrician*, vol. 85, p. 648, Dec. 3, 1920; P. O. Pedersen, *Proceedings Institute Radio Engineers*, vol. 9, p. 434, October, 1921; J. H. Morecroft, "Principles of Radio Communication."

C. Apparatus for Reception of Waves.

179. **General Principles.**—Receiving sets are divided into two general classes, those suitable for the reception of damped waves and undamped waves modulated at an audible frequency and those suitable for the reception of unmodulated undamped waves. The former involve the simpler construction, and will be discussed first. With a few modifications, a set for receiving damped waves can be adapted to receive unmodulated undamped waves. Damped waves may be received in a simple circuit containing a crystal detector or simple electron tube detector (see Secs. 182, 194) and a telephone receiver. The tone heard in the telephone receiver is that corresponding

to the frequency of the groups of damped waves. Undamped waves are ordinarily received by an electron tube method which produces beats (see autodyne method, p. 508.) These will be made clear in the diagrams which follow, where, for the purpose of explaining principles, the simplest possible sets will be shown first, even though not now used in military work.

The fundamental principle of reception of signals is that of resonance. If the receiving circuits are tuned to oscillate at the

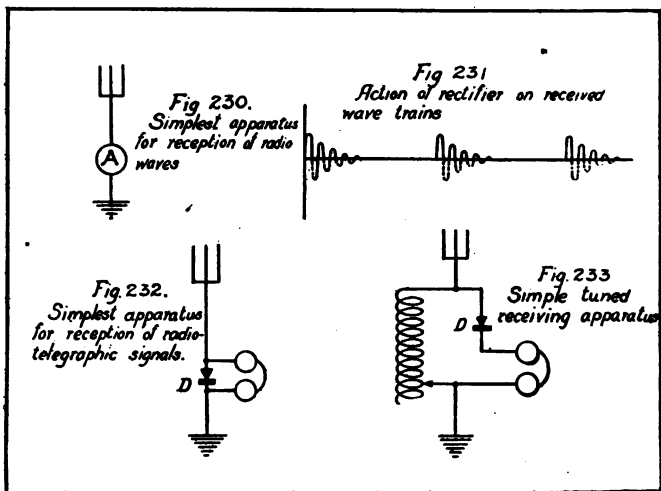

same natural frequency as the incoming waves, then these waves, though extremely feeble, will after a few impulses build up comparatively big oscillations in the circuits. In reality, then, for reception of signals all that is needed is an antenna circuit tuned to the same wave lengths as that of the transmitting station and an instrument capable of evidencing the current which flows in the antenna-connecting wire. This is shown in Fig. 230. This is the simplest possible arrangement for reception and will operate on either damped or undamped waves. A current-indicating instrument is shown at A. In practice the current is too feeble for any hot-wire ammeter. An ammeter is more suitable for quantitative measurements than for receiving

telegraphic signals, since the dots and dashes are not readily distinguished unless made so slowly as to be impracticable for transmitting messages.

Use of the Telephone.—A telephone receiver having magnet windings consisting of a large number of turns of fine wire is a much more sensitive receiving device. The action of the telephone receiver has been discussed in Section 60-b, p. 148. The diaphragm can follow the audio-frequency variations of current occurring in ordinary speech, but can not follow the very rapid radio-frequency variations. The effect is as if the diaphragm tried to go both ways at once, with the result that no observable motion takes place. For this reason a telephone receiver alone can not be used to receive radio waves. To remove this difficulty a crystal detector (see Sec. 182, p. 433) is put into the circuit, which permits current to flow in one direction but not in the other; or, more exactly, the current in the reverse direction is negligibly small compared with the current in the principal direction. See Fig. 232. Referring to the reception of damped waves, it is well to remember that the waves are in widely separated groups. The action of a crystal detector upon damped oscillations is shown in Fig. 231; the lower halves of the waves are drawn dotted to indicate the portion of the current that is cut off by the crystal detector.

It is found that the cumulative effect of one group or train of waves—for instance, that due to one condenser discharge at the transmitter—pulls the telephone diaphragm away from its neutral position. The number of such pulls per second is equal to the number of wave trains per second. With a 300-meter wave having 1000 wave trains per second the radio frequency is 1,000,000 and the audio frequency is 1000, or one is a thousand times as high as the other. The upper limit of audio frequency for the human ear is 16,000 to 20,000 sound waves per second, so that even if the telephone diaphragm could, without a rectifier, follow the radio frequency, the ear would not hear the signals. In telegraphic signaling either a dot or a dash lasts long enough to contain many wave groups, and in the telephone, where the pitch corresponds to the spark frequency, a tone is heard during the length of the dot or dash.

Simple Receiving Sets.—In Fig. 232 is shown the simplest connection for reception with a telephone receiver. It is suit-

able only for damped waves. At *D* is shown the rectifier, commonly called a "detector," although it detects nothing; it alters the waves so that the telephone can detect them. The apparatus shown receives strongest signals from a station transmitting waves of the same length, or nearly the same length, as the wave length of the receiving circuit. The fact that the current from the antenna to ground must pass through either the telephone or the detector, both of which have a high resistance, renders this circuit not very selective, so that it will respond to a wide range of wave lengths. The circuit may be tuned by inserting a variable inductor in series between the antenna and the detector, the inductance being varied to change the wave length. This connection is similar to the so-called "plain antenna connection" of Fig. 194, page 370, with the spark gap, the apparatus which supplies energy to the antenna, being replaced by the detector and telephone, the apparatus which uses the energy received by the antenna.

A simple variation of this circuit which allows fairly sharp tuning is shown in Fig. 233, in which the detector and telephone are connected at the ends of the tuning inductance. It will be seen that this circuit is analogous to the wave meter circuit shown in Fig. 216, page 393, the antenna acting as the capacity *C* and the coil *L* as the inductance, with the detector and telephone shunted across the inductance. It is well to notice how simple is the apparatus actually needed for reception, contrary to what the uninitiated person supposes. Three pieces of apparatus—telephone receiver, rectifier, and tuning coil—with a suitable antenna, are all that are necessary to receive effectively from stations transmitting damped waves.

180. **Typical Circuits for Reception of Damped Waves.**—A further improvement is the circuit shown in Fig. 234, in which the tuning coil has two adjustable connections. In the circuit shown in Fig. 233 the coupling between the antenna circuit and the detector circuit can be varied only by varying the wave length, but in the circuit shown in Fig. 234 the coupling can be varied, while the wave length is not changed.

Direct Coupled Receiving Set.—A further improvement, as regards selectivity, is shown in Fig. 235, where a variable condenser *C*₂ has been added. This is called the direct coupled connection. Let *L*₁ be the inductance in the antenna circuit, *C*₁

the capacity between the antenna and ground, and L_2 and C_2 the corresponding constants of the closed circuit, shown by heavy lines. The antenna circuit is called the primary, since the energy enters the set there. The circuit containing L_2 and C_2 is called the secondary and is the closed oscillating circuit. In the same manner in which the transmitting antenna circuit is a good radiator of power, so the receiving antenna circuit is a good absorber. It is tuned to resonance with the incoming waves by adjustment of L_1 . The power is given over magnetically to the secondary, which is tuned to resonance by adjustments of L_2 and C_2 . Comparatively large oscillations result in the secondary, producing voltages across the condenser which

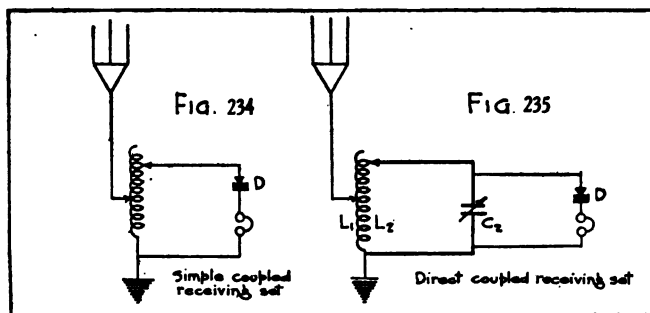

are detected by the crystal and telephone, and which are not in either oscillating circuit. The oscillations are not damped thereby, and sharp tuning is obtained.

Attention is invited to the analogy of Fig. 235 with the coupled transmitting set of Fig. 200 in Section 162, page 373. The open absorber of one corresponds to the open radiator of the other; the closed oscillating circuits correspond, each having its L and C ; shunted around the condenser in one case (Fig. 235) is the apparatus where the used energy is taken out, namely, the detector and telephone, and in the other case the apparatus where the energy is put in, namely, the power transformer with its generator.

Inductively Coupled Receiving Set.—In Fig. 236 is shown the inductively coupled receiving set. This may be taken as the standard upon which all later changes are based. A fixed

condenser of about 0.005 microfarad is shunted around the telephone and this increases the strength of the signals. Its action is explained as follows: Suppose the principal current flows downward through the detector and telephone. While this current flows the fixed condenser is charged with top plate positive. When the reversal of the radio oscillation comes the current through *D* and *T* ceases. Then the condenser discharges down through *T* and tends to maintain the current till the next oscillation downward through the instruments. In this way the gaps between the successive pulsations of rectified cur-

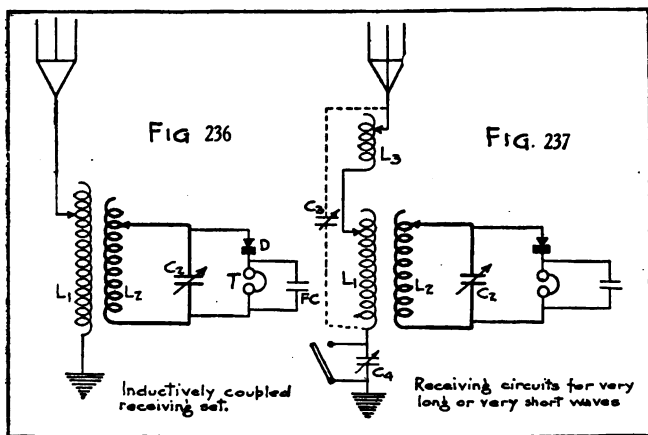

rent are filled in, and the cumulative effect of a wave group is strengthened. In practice the telephone cord, containing as it does two conductors separated by dielectric, forms a condenser which in some cases is sufficient so that an added fixed condenser gives no improvement.

The connection in Fig. 236 is similar in its action to the direct coupled arrangement of Fig. 235. In either case, on account of the coupling between the primary and secondary coils, there are reactions of each coil upon the other, with consequent double oscillations when the coils are near together. See Section 165. If the coupling is tight and the resistance high, sharp tuning becomes impossible. It is found, however, that if the coupling is not too tight and the resistance of the cir-

cuits is low, extremely sharp tuning is obtained. The antenna is tuned to the incoming waves by changes of the inductance L_1 . Sometimes if very sharp primary tuning is desired, a variable condenser is shunted around L_1 , and fine adjustments are made therewith. The secondary is tuned to the primary, the operations of tuning being done alternately until the telephone gives the best response. In the secondary the coarser tuning is done by changes of the inductance L_2 , and the fine tuning with the variable condenser C_2 .

Comparing Figs. 195 and 236 it will be found that the circuits are the same. One finds in both places the antenna circuit (radiator or absorber), the closed oscillating circuit, the coupling coils, and the power inserted or detected in shunt connections to the condenser. The main difference of apparatus is that instead of a high voltage condenser as in Fig. 195, C_2 is a small variable air condenser, and instead of spaced-turn coils of large wire, the coils of the receiving apparatus have many turns of insulated wire closely wound.

For receiving a longer wave in the primary circuit than is possible by using all of the inductance L_2 , a series inductance L_3 , called a loading coil, is added. See Fig. 237. Also a variable condenser may be connected as shown at C_3 to increase the wave length and afford fine tuning. It is better practice, however, to have the series inductance L_3 continuously variable or variable by small steps, so that it can be used for fine tuning. The secondary may also be provided with an extra inductance in series with L_2 if needed. It is possible to receive short waves on a large antenna by inserting a series condenser C_4 in the ground connection. It is short circuited when not in use. It should be noted, however, that a set used for the reception of short waves should be designed for that purpose and that best results will not be attained using a set intended for long waves and inserting capacity in series.

In the typical set of Fig. 236, a crystal rectifier (Section 179) is used as the detector. The principal disadvantage of this type of detector is that it can not be depended upon to stay in adjustment. A good deal of time is usually required for the frequent readjustments. (See Sec. 182.)

Fig. 238 shows exactly the same connection, but with the crystal detector replaced by a two-electrode electron tube, or "Flem-

ing valve," *V*. This is a glass bulb containing two electrodes and having the air exhausted. One electrode in the vacuum is a lamp filament which is heated by current from a storage battery *A*. The other electrode is a metal plate. The heated filament gives off a stream of electrons (Sec. 187) toward the plate. Current from incoming electric waves can pass through the vacuum in only one direction determined by the flow of the electrons, the current in the opposite direction being suppressed. In this way the tube acts as a rectifier. It is a very stable detector, but not very sensitive as ordinarily used some years ago.

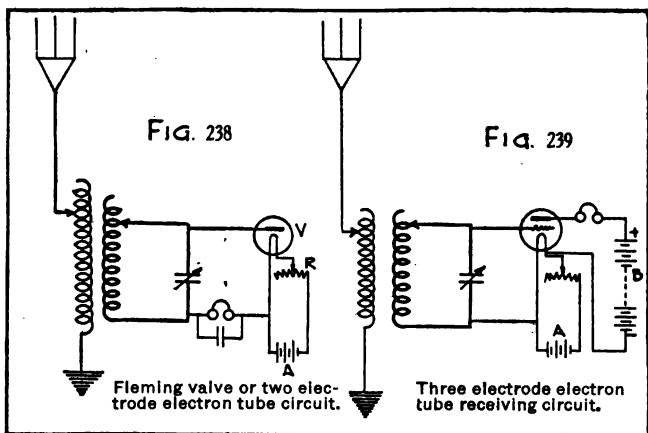

The two-electrode electron tube is now practically obsolete as a detector. Present practice is to use a three-electrode tube.

A receiving circuit using a three-electrode tube is shown in Fig. 239. It is seen here that the circuits joined to the filament and the nearer electrode are exactly the same as in Fig. 238. The telephone, however, is in a circuit with a battery *B*, and the signals received thereby are much louder than in the case of Fig. 238. For the theory and operation of the three-electrode electron tube as a detector see the next chapter, Section 194.

An inductively coupled circuit is shown in Fig. 239-a, which has been found to be particularly adapted to wave lengths shorter than 400 meters and also to give good results on longer wave lengths. In this circuit it is essential that the variable

inductances L_2 and L_3 shall be continuously variable. The name "variometer" is sometimes applied to a form of continuously variable inductance often used with this circuit. Variable inductance L_1 may be of the usual type, variable by steps. Condenser C_2 may be variable by steps, and is not necessarily continuously variable. C_1 and L_1 are adjusted to approximately the wave length of the incoming signal, but it is not essential that the primary be accurately tuned. It is, however, essential that the secondary be very accurately tuned, and inductance L_2 must be very carefully adjusted. The inductance L_3 in the regenerative circuit (see Sec. 199, p. 487) should also be

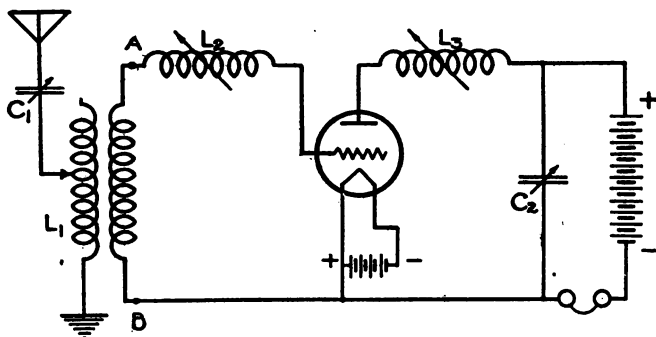

FIG. 239-a.—Tuned plate regenerative tuning circuit, using continuously variable inductances.

carefully adjusted until maximum response is secured in the telephone receivers.

This same circuit can be used for receiving continuous waves by the "autodyne" method (see Section 205, p. 503) by adjusting L_3 so that the tube is in the oscillating condition. For continuous waves the best signal will usually be received when L_3 is adjusted just above the point when the tube is in the oscillating condition. For spark reception, this circuit will usually give best results when L_3 is adjusted just below the point where the tube is in the oscillating condition.

This same type of circuit can also be used for reception with a coil antenna. (See Section 151.) In this case the antenna and receiving transformer shown in Fig. 239-a are not present; that is, in Fig. 239-a the part of the figure to the left of points

A and *B* is deleted. The terminals of the coil antenna are connected directly to points *A* and *B*.

Capacitively Coupled Receiving Set.—A method of coupling receiving apparatus to the antenna circuit which affords compactness is shown in Fig. 240. By fixing the primary and secondary coils L_1 and L_2 permanently at right angles to each other, inductive coupling between the two is prevented. Instead the coupling between the two circuits is effected through the condensers C, C_1 , which are referred to as "coupling condensers." Such an arrangement is called "electrostatic" or "capacitive" coupling. The condensers are arranged so that

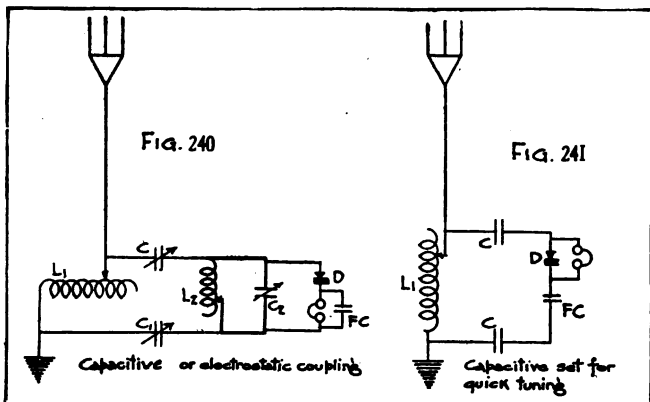

by turning one handle both are varied together. One of the condensers, C_1 , the one connected to earth, may be omitted, but better results are usually obtained with two. The advantages of capacitive coupling are as follows: (1) The coils are of compact form. They are wound as rings with rectangular or square winding section, thus giving large inductances in small space. This is a great saving of room compared with sets using variable inductive coupling where the coils must be so constructed that one of them can move with respect to the other, and where they are usually wound on long tubes in order to get suitable variation of coupling. (2) The coils are fixed. In the inductive type they must sometimes be separated many centimeters

for very loose coupling. (3) The coupling is quickly and easily changed.

Capacitive coupling, however, is not found to give as sharp tuning as inductive coupling.

Sets for Quick Tuning.—When simplicity of tuning is the principal requirement, and it is desired to reduce the tuning operations to a minimum number, even at the expense of a certain amount of selectivity, the following methods are used:

In Fig. 241 is shown a modification of the capacitive connection of Fig. 243; in practice the change from one to another is accomplished by one switch. The secondary is removed, and the telephone is put in shunt with the detector instead of with the fixed condenser *FC*. If a medium value of coupling is used it is not usually necessary to alter it; therefore the only tuning adjustment is that of the primary inductance.

Another device for quick tuning is shown in Fig. 242. This employs an inductive coupling. The primary is tuned sharply to the incoming waves, while the secondary is untuned. With the connections as shown, the secondary will respond in practically the same manner to a wide range of wave lengths, owing to the high resistance of the detector. Then the only adjustment the operator has to make is that of the primary inductance. Sometimes additional provision is made for adjustment of the coupling by separating the coils; this gives variation in the sharpness of tuning and in the signal strength.

"Stand-By" Circuits.—These are also called "pick-up" circuits. When listening for possible calls from a number of stations it is convenient to have apparatus which will respond to a wide variety of wave lengths. The circuit of Fig. 241 will do this to a limited extent if the coupling is close. This is also true of Fig. 242. Probably the most broadly tuned of all the receiving sets is the so-called "plain antenna connection" already shown in Fig. 232 or Fig. 233. It is, however, too broadly tuned to be used if many stations are transmitting.

A fairly good pick-up circuit is the ordinary inductive set of Fig. 236 when used with a tight coupling. The decrement is then high and the tuning broad. A switch may be provided, if desired, to put the receiving instruments over into the antenna circuit.

181. Typical Circuits for Reception of Undamped Waves.—While damped waves are transmitted as detached groups or trains, undamped waves are usually not separated into groups. Undamped waves, even if rectified, will not be detected in a telephone receiver unless the waves are broken up into groups in some way. This is because the telephone diaphragm and the ear can not respond to so high a frequency as that of the radio oscillations. Hence it is necessary to interrupt the undamped wave dot or dash into many groups by rapid interruptions of the current. It is arranged in practice to have, for example, 1000 interruptions a second, and as long as a signal continues a note of pitch 1000 is heard. These interruptions may be made to take place either at the transmitter or at the receiving station. A method for producing them at the transmitting station is to insert a rapidly operating circuit breaker called a "chopper" in the antenna wire; or if it is inconvenient to break the current, the chopper may be used to short circuit some of the turns of the antenna inductance coil to throw the circuits out of resonance periodically. (See Sec. 211, p. 529). This divides up the waves into groups to which the receiving telephone can respond. A rather more convenient method is to have the chopping done at the receiving station, for then the receiving operator can control the pitch of the received signals. There are at least five ways of modifying the waves at a receiving station to obtain an audible frequency: (1) A chopper in series with the detector and telephone; (2) a variable condenser with rapidly rotating plates; (3) a "tikker" used instead of a detector; (4) a "heterodyne" in a separate circuit; (5) an "autodyne" or electron tube device arranged so that the detecting tube also produces the heterodyne action. The last method is explained in Section 205, page 501.

Chopper.—This may be any device for rapidly making and breaking the current. It is inserted in the circuit of the detector and telephone as in the ordinary damped wave set of Fig. 236. It consists of a rotating toothed wheel with a stationary contact touching the successive teeth or a break controlled by an electrically operated tuning fork, or it is sometimes a light high speed vibrator similar to that of an electric bell.

Rotating Plate Condenser.—If the movable plates of the tuning condenser C_2 in Fig. 236 are rotated rapidly the apparatus will be in tune once for each revolution. Each of these revolutions will produce an impulse of the telephone diaphragm. The speed can be adjusted so that the impulses will cause sounds while waves are being received. In practice it is found best to keep part of the capacity of the condenser C_2 constant, and vary only a part of it. If the main plates were rotated the apparatus would give sounds at only a small sector of each revolution,

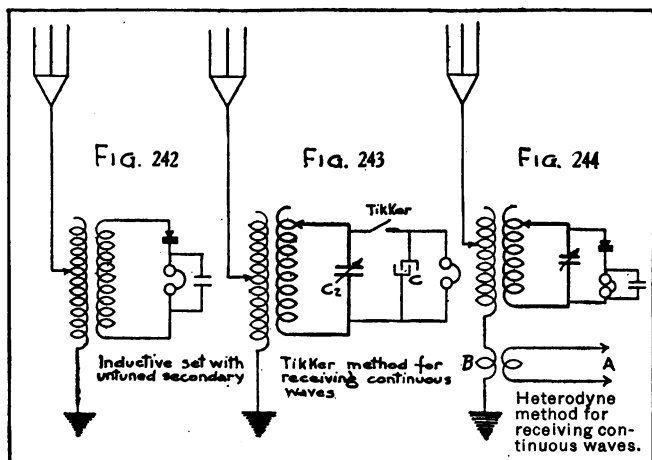

near the resonance adjustment. To accomplish a more prolonged train of impulses during one revolution the adjustment can be held near resonance for a larger proportion of the time if the rotating condenser is made very small, and is put in parallel with C_2 . The latter does not then rotate except for ordinary hand tuning. The capacity of C_2 plus the maximum capacity of the rotating condenser is adjusted to give resonance. The circuit is not far from this condition when the moving plates are farthest apart, so that the signals affect the receiver during a considerable portion of the revolution.

Tikker.—See Fig. 243. The tikker is usually a stationary fine wire of steel or gold with its end running in the groove of a

smooth, rotating brass wheel. It is a slipping contact device. The wire does not remain in perfect contact with the wheel, but owing to the slight irregularities there are variations of contact, which in effect keep making and breaking the circuit. With the tikker contact open, suppose the secondary inductance and condenser C_2 to be tuned to resonance with the incoming waves. If now the tikker is closed when C_2 has any stated value of charge, some of the charge will be given to the condenser C and furthermore the radio oscillations cease because the addition of C throws the apparatus out of tune. When the tikker is opened the condenser C discharges through the telephone, and in the meantime the secondary oscillations build up again, ready to give a charge over to C when the contact is closed. In this manner the current impulses through the telephone are of the same frequency as the operation of the tikker, and this can be controlled by the speed of the wheel. The capacity of C should be about 1 microfarad. No separate rectifier is needed. The tone obtained is not musical, since C_2 is charged to different potential differences at the different times when the tikker closes, and the action depends also upon somewhat irregular contact.

Heterodyne.—In this method an apparatus is arranged to produce undamped electric oscillations in the receiving circuit, of nearly the same frequency as that of the waves which are being received, and their combined action is made to affect the receiving telephone. Beats are produced having a frequency equal to the difference of the frequencies of the two waves. The connections are shown diagrammatically in Fig 244. Any source of undamped or slightly damped oscillations is connected at A . In the antenna circuit at B is a single turn or loop, coupled inductively to A . The antenna circuit thus gets the effect of the oscillations from A as well as from the incoming waves. Suppose those received have a frequency of 100,000, and the heterodyne A is adjusted to give a frequency of 99,000. As long as both act, the telephone will respond to a pitch of 1,000 vibrations per second, which is of course audible. When the incoming waves cease the heterodyne continues to act alone at 99,000 cycles, but is inaudible. Therefore signals are heard only during the time when the incoming radio waves are re-

ceived. Further information regarding heterodyne reception is given in Section 205, page 501.

Receiving from a Radio Telephone Transmitter.—In radio telephony, speech is transmitted by means of continuous waves, the amplitude of which is varied in accordance with the wave form of the sound which is being transmitted, and these variations occur at the speech frequency, which is, of course, an audio frequency. The speech can therefore be received with a crystal detector or a simple electron-tube detector, just as damped waves, or continuous waves interrupted by a "chopper" at the transmitting station would be received. Any type of apparatus suitable for the reception of damped waves may, in general, be used for reception in radio telephony. If the received signal is feeble, it may be necessary to use amplifiers, as in the case of any feeble signal. In some cases better results may be secured by adjusting the circuits or the diaphragm of the telephone receiver for a particular audio frequency. A "chopper," or "tikker" can not be used at the receiving station for receiving in radio telephony, and if the effort is made to do so, the speech is altogether unintelligible. The transmitting equipment and the wave forms used in radio telephony are described in Sections 206-210. In Fig. 294, page 528, there is shown the circuit used in a Signal Corps set for the reception of radio telephone messages. The uninitiated person often assumes that particular forms of elaborate apparatus are required for reception in radio telephony, but this is not the case.

182. *Contact Detectors.*—A very simple and convenient kind of detector is obtained by placing in contact two dissimilar solid substances properly chosen. Many different substances have been found suitable for use in such detectors. This type of detector is easily portable, but the most sensitive forms require frequent adjustment. The electron tube, when properly connected, is a far more sensitive detector, but is subject to breakage in field work. For field sets, where a compact and easily portable form of detector is required, the contact detector is very convenient. The use of contact detectors is largely confined to such work now, and even in the portable military sets the contact detector is being largely replaced by the electron-tube detector.

Crystals.—A contact detector may be formed by the contact of two dissimilar metals. Thus, a contact of a steel point on a piece of metallic silicon forms a good detector. Detectors can also be made by a contact of carbon with steel and tellurium with aluminum. The fused metallic silicon commonly used is a product of the electric furnace.

The most important class of contact detectors consists of selected specimens of crystals, either native minerals or artificial, in contact with a metallic point. Examples of minerals which can be so used are galena, iron pyrites, molybdenite, bornite, chalcopyrite, and zincite. Carborundum, which is crystalline silicon carbide formed in the electric furnace, can also be used. Galena is lead sulphide, crystallizes in cubes, and is blue-gray, usually with a metallic luster. Iron pyrites is a sulphide of iron, crystallizes in cubes, and is bright yellow, usually with a metallic luster. Molybdenite is a sulphide of molybdenum, is blue-gray, and can usually be separated into thin sheets somewhat like mica. Bornite and chalcopyrite are combinations of the sulphides of copper and iron. Zincite is a natural red oxide of zinc.

Sensitive iron pyrites detectors are often sold under the trade name "Ferron." The detector sold under the name of "Perikon" consists of a bornite point in contact with a mass of zincite. The name "Lenzite" has been applied to an impure galena found in some localities, which is sometimes sensitive.

Crystal detectors, particularly galena, may have their sensitivity entirely destroyed by the application of even moderate heat. They are usually mounted in an alloy having a low melting point, such as Wood's metal, which will melt in hot water. The alloy is usually contained in a small metal cup a little larger than the crystal. A sensitive galena crystal may become almost worthless if mounted in ordinary solder.

Different kinds of detectors require different kinds of contacts. With galena satisfactory results are obtained only with a light contact made by a fine wire, perhaps No. 30 or smaller, which makes contact with only a very small surface. Iron pyrites and molybdenite usually give best results with a fine-wire contact, but can be used with larger points. Silicon can be used with a fine-wire contact, but will also give good results in contact with the end of a small machine screw under consider-

able pressure. The screw is usually tapered to a blunt point. Iron pyrites is sometimes used in contact with the tapered point of a screw, under pressure. Carborundum gives best results with a contact of appreciable area under considerable pressure, providing the contact is made with the most sensitive spots, which may be deep in the mass of crystals in a specimen.

For service in the field or on shipboard, where it is necessary to have rugged instruments which require very little adjustment, silicon or carborundum, in contact under considerable pressure with the blunt point of a screw, are therefore most desirable. With silicon and carborundum the same contact may be used for a considerable time. For permanent land stations, where new crystals are easily available and new adjustments can be easily made, the more sensitive galena crystals are preferable.

It is usually necessary to examine a considerable number of specimens of any of these minerals before a crystal is found which is sensitive as a detector. The three most widely used contact detectors are probably galena, iron pyrites, and silicon. Pieces of metallic silicon are usually sensitive. Sensitive specimens of galena are obtained only by careful selection, and sensitive iron pyrites is still harder to find. Good specimens of galena and iron pyrites are usually the most sensitive crystal detectors. Sensitive specimens of molybdenite are much more easily found, but molybdenite is usually much less sensitive than galena or iron pyrites. Crystals should be kept in a closed box when not in use for any considerable period of time, and when picked up should be handled carefully with tweezers or a cloth, so that they will not come into contact with the fingers. Repeated contact with the fingers may almost entirely destroy the sensitivity of a good specimen of galena. A galena detector will become much less sensitive after a few months' exposure to the air, whether in service or not. Iron pyrites will usually retain its sensitivity much longer when exposed to the air than galena. Carborundum and silicon are also not so seriously affected by exposure.

On the surface of a given sensitive crystal of most kinds different points will vary greatly in sensitivity. This is particularly true of galena and iron pyrites, and to some extent

of carborundum. Good specimens of fused metallic silicon usually have sensitive spots all over their surface, which vary comparatively little in sensitivity. A sensitive spot on a galena crystal may entirely lose its sensitivity if acted upon by an unusually strong signal, caused, for instance, by strong static. When this occurs it is necessary to move the fine-wire contact around until a new sensitive spot is found. The most sensitive spots on carborundum are often found deep in the spaces between the faces of the crystals which form the usual specimen.

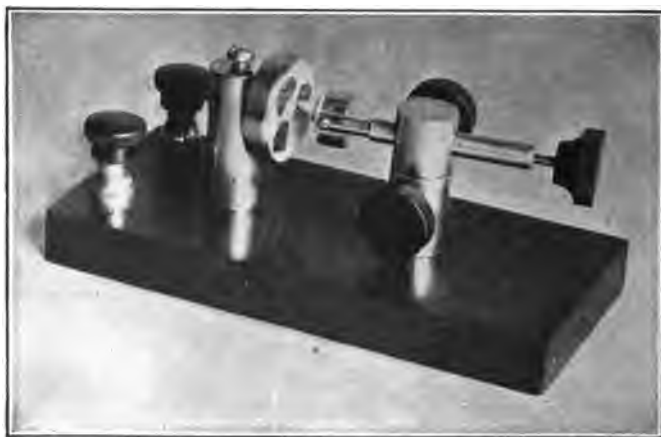

FIG. 245.—One method of mounting crystal detectors.

For some purposes it is desirable to have a permanent contact detector which will not require any readjustment of the contact at all. There are several ways in which such detectors may be constructed, but in general they are found to be much less sensitive than the same crystal used with the appropriate form of adjustable contact. One form of permanent contact detector has a fine wire soldered to a small piece of molybdenite, but this detector will give a much weaker signal than the same piece of molybdenite with a fine-wire adjustable contact. If the sensitive spot of a permanent contact detector is destroyed by too strong a signal, the detector is,

of course, no longer useful, since a new sensitive spot can not be used.

Fig. 245 shows a typical crystal detector which is formed by a contact of silicon and antimony.

Properties.—In order to act as a detector for radio signals, a contact detector should either (1) allow considerably more current to flow when a given voltage is applied in one direction than when it is applied in the opposite direction or (2) its conductivity should vary as different voltages in the same direction are applied. Practically all detectors formed by the contact of two dissimilar substances possess both of these properties, at least to a slight extent. The first property is sometimes referred to as the property of "unilateral conductivity," or simply the property of "rectification," and is the property made use of in most contact detectors.

To make use of the second property, an auxiliary battery is required in series with the crystals, as explained below. Such a battery is seldom used with any crystal except carborundum. Some crystals, such as galena, silicon, and iron pyrites give about as good results as simple rectifiers as when the auxiliary battery is used. They are ordinarily used without the battery, to simplify the apparatus.

Figs. 246 and 247 show a current-voltage characteristic curve for carborundum in contact with a metal. Such curves are obtained by applying known voltages to the crystal and measuring the current which flows. The curves show that the current flows much more readily in one direction than in the other under equal but opposite voltages. For example (Fig. 246), under a constant impressed emf. of 10 volts in one direction a current of 100 microamperes is obtained, while with the voltage reversed the current is only 1 microampere. This illustrates the property of "unilateral conductivity," or rectification. The second property is shown in both Figs. 246 and 247. When the voltage is applied in the direction giving the larger current, the conductivity (the ratio of current to voltage) increases as the voltage increases. This is shown in the right-hand portion of Fig. 246. The conductivity of an ordinary metallic conductor would remain constant with varying voltages, and its characteristic curve would be a straight line.

The question whether a given crystal detector can be used without an auxiliary battery depends entirely on its current-voltage characteristic curve. If the characteristic curve is practically zero to the left of the point representing zero voltage and rises rapidly immediately to the right of the point representing zero voltage, good results may be obtained without an auxiliary battery. The rise will, of course, be most marked if

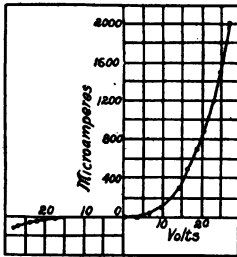

Fig. 246 Curve showing the carborundum detector to conduct in one direction better than the other.

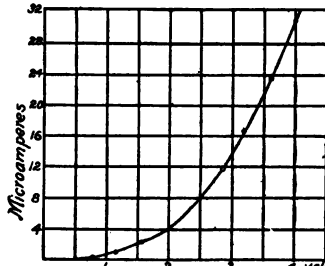

Fig. 247. Curve showing Current-Voltage Characteristic of Carborundum Detector.

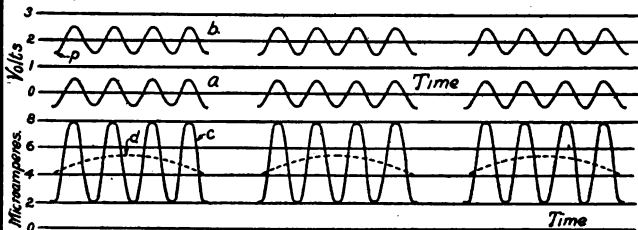

Fig. 248 Action of crystal detector with booster battery.

the characteristic curve is concave downward. Galena, iron pyrites, silicon, and various other substances are so used without a battery. The incoming voltage oscillations vary from a small positive voltage to a small negative voltage of the same value. When positive voltages exist the crystal allows a current to flow whose value is determined by the characteristic curve, but does not allow any current to flow when negative voltages exist. If the curve slopes rapidly upward to the right from the point corresponding to zero voltage, as is the case with

the crystals just mentioned, the current flowing when positive voltages exist will be of appreciable magnitude, and in a circuit containing only resistance will be a direct current pulsating between zero and a maximum value. If the incoming voltage oscillations are trains of damped waves having an audible train frequency, or undamped waves broken up into groups of an audible frequency, the pulsations of the rectified current will produce a note in a telephone receiver connected in the circuit corresponding to the train or group frequency. The addition of the inductance of the windings of the telephone receiver to the circuit smooths out the pulsations of the rectified current, so that the pulsations do not drop to zero with each radio-frequency cycle.

Booster Battery.—In order to make use of the second property—namely, the curvature of the current-voltage characteristic—a local or “booster” auxiliary battery is inserted in series with the crystal. The voltage of the booster battery is adjusted so that the crystal operates at the sharpest bend of the characteristic curve, so that a slight increase of voltage in one direction will produce a fairly large increase of current while an equal decrease of the voltage on the crystal will produce a relatively smaller decrease of current.

The action of the booster battery can be understood by reference to Figs. 247 and 248. Suppose the carborundum crystal is used with a booster battery which is adjusted to supply two volts to the receiving circuit in which the crystal is used. Consider this circuit to be subjected to incoming radio waves which cause the voltage in the receiving circuit to vary from -0.5 volt to $+0.5$ volt, these variations occurring at the radio frequency. In Fig. 248, curve *a* represents the voltage induced in the circuit by the incoming waves. The resultant voltage wave acting on the crystal is at each instant two volts greater than the value of the induced voltage, and is represented by curve *b*. Under the minimum instantaneous applied voltage of 1.5 volts, shown at point *p* in curve *b*, the crystal will allow a current of 2 microamperes to flow, as shown by curve *c* in Fig. 248. For the maximum instantaneous applied voltage of 2.5 volts, a current of 8 microamperes will flow. These two instantaneous values of the current are determined by the characteristic curve of Fig. 247. Curve *c* represents the condition

which would exist in a circuit containing no inductance nor capacity. Fig. 248 shows undamped waves, which are broken up into groups as by a "chopper." In actual reception, both inductance and capacity are present, and the actual current wave through the telephone receivers, as smoothed out by the inductance of the telephone receiver windings and the other inductance in the circuit, is shown in curve *d*. During the time that the incoming voltage oscillations are acting the average value of the current *d* is somewhat greater than four microamperes. Between wave trains, when no incoming voltage oscillations are acting, the current *d* drops to just four microamperes, corresponding to an applied voltage of two volts. The current *d* in the telephone receivers thus comes in pulses having the same frequency as the frequency of the groups into which the incoming oscillations are broken up, and the note heard in the telephone receiver will correspond to this frequency. If damped waves are being received, the note will, of course, correspond to the train frequency of the damped waves.

When a contact detector is used under ordinary operating conditions, it is approximately true that the rectified current is proportional to the square of the amplitude of the incoming voltage oscillations. This is a relation which holds for any kind of simple detector which operates by virtue of the curvature of the current-voltage characteristic curve, as long as the incoming oscillations are of only moderate intensity. A contact detector used without a booster battery really operates by virtue of a sharp curvature of its characteristic curve at zero voltage, and both classes of contact detectors mentioned above operate by virtue of the curvature of this characteristic curve.

183. Telephone Receivers.—The construction of a telephone receiver of the watchcase type has been described in Section 60b, page 148. This is the type of receiver commonly used in radio work. The distinctive features of telephone receivers for radio work are lightness of the moving parts and the employment of a great many turns of wire around the magnet poles. The lightness of the moving parts enables them to follow and respond to rapid pulsations of current. The large number of turns of wire causes a relatively large magnetic field to be produced by a feeble current. The combined effect is to give a device which will respond to very feeble currents. Since the size of wire used

varies very little (usually B. & S. No. 40 copper), the amount of wire, and therefore the number of turns, is usually specified indirectly by stating the number of ohms of resistance in the windings. The resistance of the windings of each of a pair of receivers for radio work is seldom less than 500 ohms, and may be as high as 4000 ohms, the values of resistance being measured with direct current. For radio work the windings of the two receivers constituting a pair are almost always connected in series.

The diaphragm of the ordinary watchcase receiver has one frequency to which it will respond most strongly; this is the "resonant frequency" of that receiver. For some purposes it is desirable to vary this frequency, but for the ordinary type of receiver the resonant frequency can not be varied except with much inconvenience. Special types of receivers have been devised in which the resonant frequency can be easily varied; these are sometimes called tuned telephone receivers. In one type of tuned receiver made by S. G. Brown, of London, the variations of the magnetic field operate a vibrating reed which is attached to a non-magnetic diaphragm. The position of the vibrating reed can be adjusted by a set screw and the resonant frequency of the receiver thus varied.

Another type of receiver sometimes used is the mica-diaphragm receiver. The regular diaphragm is made of mica and is placed in the usual place in the receiver, but of course is not acted upon directly by the magnets. Between the magnet poles a soft-iron armature is pivoted inside a solenoidal winding. It is arranged so that as it moves in response to changes in the magnetic field a small stiff wire transmits the motion to the mica diaphragm. The armature is so mounted that there is no pull upon it except when pulsations of current are passing through the coil. This is different from the ordinary magnetic telephone receiver, in which the magnet is always exerting a pull on the diaphragm. Since there is no strain in the diaphragm between pulsations, the vibratory movements caused by incoming signals are greater than if a strain were already existing in the diaphragm or armature.

A similar construction is employed in the "loud-speaking reproducer," which is often used at large public gatherings for transmitting the voice of the speaker to a considerable dis-

tance. The loud-speaking reproducer is a telephone receiver with large magnets having windings of low resistance. In one type of American loud-speaking reproducer the windings of the large magnet have a resistance of about two or three ohms. In this same type the armature is a small coil of fine wire in the shape of a ring, which moves up and down in the ring air gap of a cylindrical electromagnet. The armature is attached by a

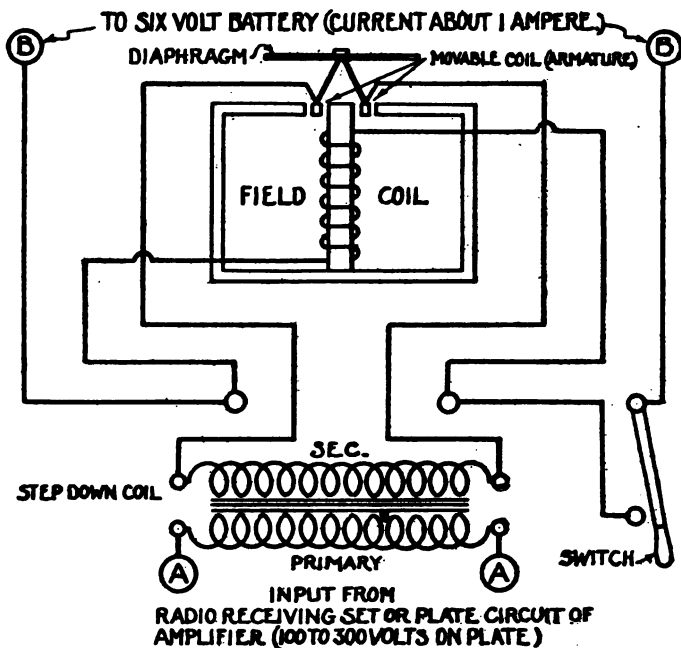

FIG. 248-A. ONE TYPE OF LOUD-SPEAKING REPRODUCER.

small rod to the center of the metal diaphragm, which may be aluminum. These reproducers are commonly used in connection with electron tube amplifiers of special design. (See Chap. 6.) One type of loud-speaking reproducer is shown in Fig. 248-A. The construction of one type of loud-speaking reproducer is described in United States Patents Nos. 1286988 and 1329928.

Impedance.—The impedance of telephone receivers depends upon the frequency of applied voltage. Around the range of audio frequencies the receivers act as an inductive reactance in series with a resistance, both increasing fairly regularly with frequency, except for a drop in both at the natural or resonant frequency of the diaphragm, where considerable energy is absorbed because of the motion of the diaphragm. For radio frequencies the capacity between the leads to the receiver is important. Here the receiver set (the two receivers with the leads) acts as a capacity reactance in series with a resistance. The resistance of a set for fairly high frequencies, such as 600,000 cycles, is usually lower than the resistance measured with direct current. A considerable part of the current is shunted by this capacity and does not pass through the telephone receiver windings. The capacity is not, however, ordinarily sufficiently large to constitute a path of negligible impedance for the radio-frequency current, and to take the place of a regular by-pass condenser of proper capacity in cases in which a by-pass condenser is required.

It is the practice of some manufacturers to mark telephone receivers for radio use as having a certain number of ohms "A. C. Resistance," the quantity so marked being the impedance measured at a certain frequency which varies with different manufacturers. In the case of one American manufacturer "A. C. Resistance" means the impedance at 800 cycles; in the case of another it means the impedance at 1000 cycles.

When using a receiving set, both the radio-frequency and the audio-frequency impedances will be of importance. Practically none of the radio-frequency current passes through the receiver itself, but practically all of the audio-frequency current passes through the receiver windings and is effective on the diaphragm.

184. Receiving Coils and Condensers.—The coils used in receiving apparatus are very simple in construction. They are usually wound in a single layer on an insulating tube, which may be pasteboard, wood, fiber, one of the materials called "bakelite," or some other material. The wire is covered with an insulation of silk or cotton and is sometimes stranded. A common type of receiving transformer is shown in Fig. 249. This is often called a "loose coupler." The points of the

switches are connected by tap wires to the turns of the wire in the coils. On the primary one switch usually takes care of single turns, and the other switch makes contact to groups of perhaps 10 turns each. To cover 100 turns of coil, for example, one switch used for coarse adjustment would have 9 points of 10 turns each and a zero point, making 10 points in all, and the units switch would also have 9 points and a zero point. Then any number of primary turns from 0 to 100 turns could be used. If the primary had 400 turns, the first switch in groups of 20 turns could have 20 points, including zero, and the unit switch could also have 20 points for 19 unit turns and zero.

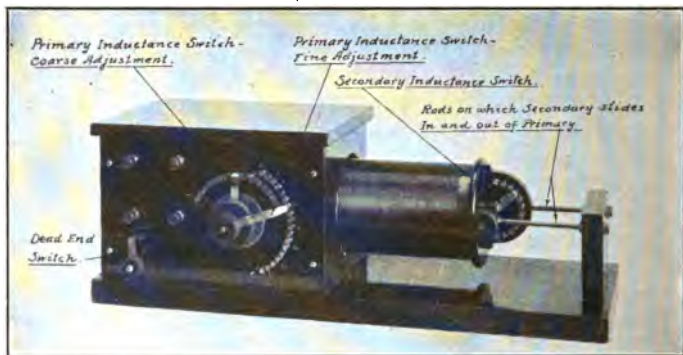

FIG. 249.—Receiving transformer.

Other arrangements can be used. In the receiving transformer shown in Fig. 249 one primary switch has 34 turns between points, and the other switch has 2 turns between points. The secondary switch adjusts by groups of turns; fine tuning is accomplished by a variable condenser. The coupling between the primary and the secondary is loosened by pulling the secondary out of the primary. The switches of the transformer are adjusted until the approximate wave length range of the station which it is desired to receive is reached. The secondary circuit is then tuned by a variable condenser to the station which it is desired to receive.

Some coils used in radio receiving sets have more than one layer. Fig. 250 shows a coupling coil with a type of winding

which resembles a lattice. This type of coil is variously called "lattice wound," "cellular," "basket wound," "honeycomb." A slightly modified form, in which the wires in successive layers are slightly staggered with reference to each other, is called a "duo-lateral" coil. Advantages of this type of winding are that a winding of given inductance occupies a smaller space



FIG. 250.—Lattice-wound variable coupling coil.

than if a single-layer winding were used and that the distributed capacity of the winding is small. The mechanical construction of this type of coil does not readily permit of coupling at short wave lengths. They have not been found to give very satisfactory results on wave lengths less than 2500 meters.

For use in receiving, a type of inductance coil has recently been developed which is called "stagger-wound," "spider-web,"

or "basket woven." The frame of this type of coil consists of radiating arms arranged like the spokes of a wheel. The wire is wound in successive turns in and out around the arms. The wire starts from the center and is wound until it reaches the extremities of the arms. In most cases an odd number of arms is used, and therefore adjacent turns are on opposite sides of and separated by an arm. With this type of construction, very compact coils may be made. An important advantage of this



FIG. 251.—Rotary variable air condenser.

kind of coil is that the construction results in low distributed capacity of the winding, which is particularly important in receiving short wave lengths. The construction of a coil of this type is described by George Adams, *Radio News*, volume 3, page 293, October, 1921.

When the inductance of the receiving transformer is not large enough to be tuned to the wave length to be received, additional inductance coils or "loading coils" may be used. Loading coils are not at present used as extensively as they

have been in the past; present practice is to have more than one receiving set, if necessary, to cover the wave-length ranges at which it is desired to work. The inductance of any par-



FIG. 252.—Simple receiving set (Signal Corps Type SCR-54-A), portable cabinet type.

- | | |
|---------------------------------|-------------------------|
| 1. Primary inductance switch. | 5. Secondary condenser. |
| 2. Secondary inductance switch. | 6. Crystal detector. |
| 3. Coupling adjustment. | 7. Test buzzer. |
| 4. Antenna series condenser. | |

ticular inductance coil can be calculated by reference to Section 170.

Fig. 251 shows a type of variable condenser with air dielectric, which is in general use. The maximum capacity is about

0.0005 microfarad, adjustable to a minimum of nearly zero. A set of semicircular metal plates is rotated between a corresponding set of fixed plates, forming alternate layers of air dielectric with adjacent conductors of opposite polarity. In receiving sets employing electron tubes, it is particularly true that most of the tuning is done with variable condensers. For the reception of continuous waves very sharp tuning is required; for this purpose a variable series condenser may be used in the primary circuit, and a small variable condenser, called a "vernier" condenser, connected in parallel with it.

Fig. 252 shows, with the various parts marked, a typical simple receiving set in cabinet form, with the tap switches and variable condensers, and a knob for changing the coupling between the primary and secondary coils. A considerable number of different kinds of receiving sets are on the market. Much care is required to design a receiving set which will be satisfactory under the varying conditions met in practice.

185. Measurement of Received Current.—The current received by a radio receiving set can be measured with suitable apparatus. One simple method of doing this is by the use of a crystal detector and galvanometer; by this method currents as small as 10 microamperes can be measured. This experiment requires careful manipulation; information regarding it is given on pages 167 to 170 of Circular 74 of the Bureau of Standards. The measurement of the received current is of interest in comparing the intensities of the signals received from different stations, with the same receiving apparatus. Rough comparisons of signal intensity are often recorded in the log kept by radio operators, and it is sometimes desirable to make more accurate comparisons.

The careful comparison of two signals is a measurement requiring apparatus which is usually available only in large laboratories. A simple method of obtaining approximate results for purposes of rough comparison is the "shunted telephone method." A resistance is placed in parallel with the telephone receiver and the resistance is reduced until the limit of audibility in the telephone is reached—that is, until the sound in the telephone becomes so weak that the operator can just barely distinguish between dots and dashes. If t is the impedance in ohms of the telephone for the frequency of the

current pulses through it, s the impedance of the shunt, I_t the least current in the telephone which gives an audible sound, and I the total current flowing in the combination of the telephone and shunt,

$$\frac{I}{I_t} = \frac{s+t}{s}$$

This ratio, $s+t$ to s , is called the "audibility" of the signal. It can be expressed in units of current if proper calibration is made. This measurement is, of course, affected by the sensitiveness of the ear of the operator. A set consisting of a pair of telephones and a variable resistance used as a shunt, which has been calibrated, is sometimes called an "audibility meter."

There are a number of other methods of measuring signal intensity which are more accurate; in some cases the signal to be measured is compared with a locally generated signal of known intensity. The more accurate measurements require apparatus not available in the ordinary station.

An idea of the relative sensitiveness of detectors may be obtained from the following comparison, in which the current values given are the lower limiting values of antenna currents which will give satisfactory reception with the type of detector mentioned, when used with a good telephone receiver. The values here given should be considered as only approximate, since actual receiving apparatus and conditions are subject to considerable variations—for an ordinary crystal detector, a current of 50 microamperes; for an exceptionally sensitive crystal, 10 microamperes; for the ordinary electron tube with simple detector circuit, 10 microamperes. For specially good detector tubes containing gas or for the ordinary tube connected in a circuit for regenerative amplification, 1 microampere; for an oscillating tube operating in a good circuit under satisfactory conditions, 0.01 microampere.

CHAPTER 6.

ELECTRON TUBES IN RADIO COMMUNICATION.

186. The Development of the Electron Tube.—During the past few years there has been added to the apparatus employed in radio communication a new device, called the “electron tube,” which has made possible many important advances in the art. A small electron tube of a simple type resembles closely in general appearance an ordinary 10-watt incandescent electric lamp. Since these tubes may be used for a variety of purposes—to generate, to amplify, and to modulate radio oscillations, as well as to detect them—they now are used in most types of radio apparatus. New applications have come rapidly, and there is every reason to believe that further developments may be expected. The electron tube is of primary importance in radio communication, but it has many important applications in other fields of electrical engineering, particularly in ordinary telephony with wires, where its use makes possible conversation between points separated by a distance of 3000 miles. One fact of importance is that such tubes make possible the use of apparatus that is easily portable—a primary consideration in military communication, and of importance also in various commercial applications. The principles which underlie the operation of electron tubes and their action under the widely different conditions met in actual practice therefore deserve careful study.

A. The Electron Flow in Electron Tubes.

187. The Electron and the Two-Electrode Tube.—The name “electron tube” is derived from the fact that the action of the tube is due to very small particles of matter called “electrons.” An electron is much smaller than an atom, and is the building block of which atoms are constructed. An idea of the extremely small size of the electron may be obtained from the estimate that in a very tiny spherical globule of copper having a diameter of one one-hundred-thousandth of an inch, there are about 20 billion electrons. The atom was for-

merly regarded as the smallest particle of matter which could exist; something like 25,000 hydrogen atoms would have to be placed in contact in a row to make up a length of one ten-thousandth of an inch. The weight of an electron is only about one two-thousandth of the weight of a hydrogen atom. An electron carries a charge of negative electricity whose value can be measured. Since the comparatively recent general recognition by scientific men of the existence of the electron, many ideas formerly held as the explanations of various physical phenomena have been considerably modified. The fact that the electron carries a charge of negative electricity makes possible the use of the electron tube in radio communication. For further information regarding the electron the reader may consult a book by R. A. Millikan, *The Electron*.

If two wires are connected to a battery, one to each terminal, the other two ends of the wires may be brought very close together in air, yet so long as they do not touch no current flows between them. The two ends may be inclosed in a bulb like that of an incandescent electric lamp and the air pumped out, and still so long as the ends are separated no current will flow. Thus, when the filament in an incandescent electric lamp breaks, the current stops and the light goes out.

About 1884 Edison discovered that if inside an exhausted incandescent electric lamp of the ordinary type, containing a filament whose two ends were connected to two wires insulated from each other, there was introduced a third wire insulated from the filament connections and maintained at a voltage positive with respect to the filament, then a current would flow across the vacuum inside the tube from the third wire to the filament as long as the filament was incandescent, but that the current ceased as soon as the filament became cold. This phenomenon is generally called the "Edison effect." It is due to the fact that the incandescent filament shoots off electrons at high velocity, each carrying its charge of negative electricity, and that the electrons are attracted to the positively charged third wire. The passage to the third wire of the negative charges of the electrons is equivalent to the flow of a current between the filament and third wire. In order that a current of one-billionth of an ampere should flow between the

filament and the plate, it is necessary that more than six billion electrons should pass each second from the filament to the plate. It should be particularly noted that while the electrons move from the heated filament to the cold third wire, the current passes from the third wire to the filament, according to the usual idea that the direction of an electric current is from the positive (higher) to the negative (lower) voltage. This distinction between the direction of *electron flow* and the direction of *current flow* should be carefully noted.

As each electron leaves the filament, the filament acquires a charge of positive electricity equal in amount to the negative charge carried by the electron. If no voltage is applied to the third wire, electrons will still be emitted by the incandescent filament, but will travel only a very short distance before being attracted back to the filament by the positive charge acquired by the filament. The voltage applied to the third wire must be sufficient to overcome this attraction of the filament. No current will flow if the negative terminal of the battery is connected to the third wire, because the electrons will not be attracted by the negatively charged third wire, and, in fact, will be repelled back into the filament.

A tube containing a filament and one additional wire or other piece of metal, is called a two-electrode tube, the filament being considered as one electrode, and the additional piece of metal the second electrode. Fig. 253 shows the essential elements and connections of a two-electrode tube. The additional piece of metal inside of the tube is here a small plate of metal. The current which flows between the filament and plate is often called the "plate current."

188. Ionization in Electron Tubes.—The above explanation of the mechanism of the flow of current between the filament and plate in an electron tube applies to a tube having a very perfect vacuum. If there is more than the merest trace of gas remaining in the tube, the operation is more complicated, and a larger current will usually flow with the same applied voltage. This happens in the following manner.

In a rarefied gas some of the electrons present are constituent parts of atoms and some are free. These free electrons move about with great velocity, and if one of them strikes an atom

it may dislodge another electron from the atom. Under the action of the emf. between plate and filament the newly freed electron will acquire velocity in one direction—the direction in which the colliding electron is moving—and the positively charged remainder of the atom, called an “ion,” will move in

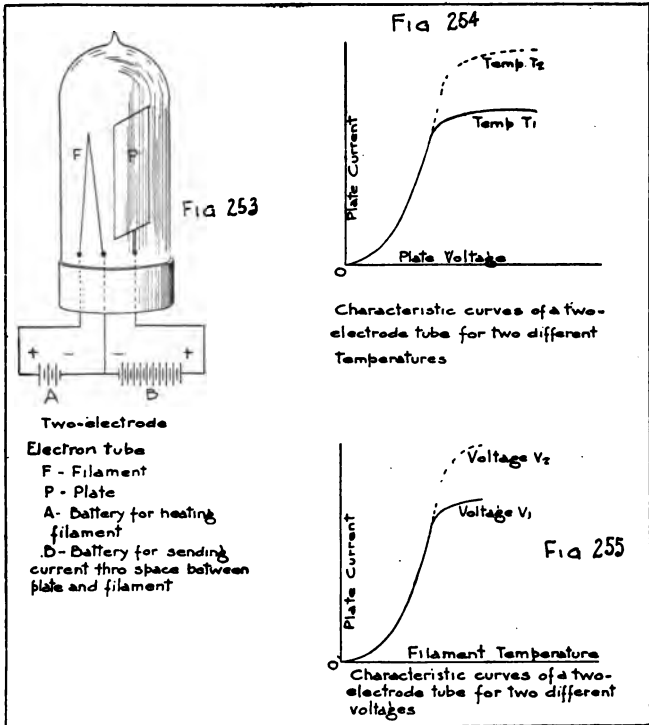

the opposite direction. Thus both of the parts of the disrupted atom become carriers of electricity and contribute to the flow of current through the gas. This action of a colliding electron upon an atom is called “ionization by collision,” and, on account of it, relatively large plate currents are obtained in electron tubes having a poor vacuum. The earlier tubes were of this

sort, but at the present time most tubes are made with a better vacuum than formerly, so that ionization by collision is responsible for but a small part of the current flow.

At first it would seem to be an advantage to have ionization by collision, because a larger plate current can be obtained, but there are two difficulties which have proved so great that tubes are now usually so made as to have only the pure electron flow. The first of these difficulties is a rapid deterioration of the filament when there is flowing a large plate current which is caused by ionization by collision. The positively charged parts of the atoms are driven violently against the negatively charged filament, and since they are much more massive than electrons (an oxygen or nitrogen ion has about 25,000 times the mass of an electron), this bombardment actually seems to tear away the surface of the filament. A second disadvantage of tubes with poor vacuum is that too large a battery voltage may cause a "blue-glow" discharge; the difficulties connected with the presence of this visible kind of current flow are mentioned in Section 194.

Two similar tubes with poor vacuum seldom, if ever, contain just the same quantity of gas, and therefore their electrical characteristics may be considerably different. For this reason it is not ordinarily practicable to connect in parallel two tubes having poor vacuum. Tubes with high vacuum, on the other hand, can be constructed very uniformly, so that a number can be connected in parallel. It is often advantageous to be able to connect several tubes in parallel in generating sets.

Tubes containing a little gas, i. e., having a poor vacuum, are often called "gas tubes," or "soft tubes." Tubes with high vacuum are often called "hard tubes." "Soft" tubes are particularly useful as detectors, and if properly selected and used may be much more satisfactory as detectors than "hard" tubes of similar construction.

Let us consider what happens in a two-electrode tube having a good vacuum, when there is a variation in either the temperature of the filament or the voltage of the battery connected between the plate and filament.

189. Characteristics of Two-Electrode Tubes.—*Effect of Plate Voltage.*—Suppose first that the filament temperature is kept

constant. Then a definite number of electrons will be sent out per second.¹ The number of electrons that travel across the tube and reach the plate per second determines the magnitude of the current through the plate circuit. The number of electrons that reaches the plate increases with an increase of the battery connected between the plate and filament (*B*, Fig. 253). If this voltage is continuously increased, a value will be reached at which all the electrons sent out from the filament arrive at the plate. No further increase of current is possible by increasing the voltage, and this value of current is called the saturation current. This is illustrated in Fig. 254 (full line curve), which shows that when the voltage applied to the plate is small (horizontal distance) the current flowing between filament and plate, which, as has been stated, is called the plate current (vertical distance), is also small, but if the voltage applied is made larger the plate current increases more rapidly than the voltage up to a certain value. The bend in the curve shows that when the voltage has been made large enough there is little further gain in current.

If now the temperature of the filament is raised to a higher constant value by means of the filament-heating battery and the same voltage steps again applied, the plate current curve will coincide with that obtained before, until the bend is reached; then it will rise higher, as shown by the dotted portion of the curve in Fig. 254. The explanation of this is that the number of electrons sent out by the filament increases with the temperature approximately as the square of the excess of the filament temperature above red heat, and thus more electrons are available to be drawn over to the plate. Thus a higher value of plate current will be obtained before reaching the limiting condition when all the electrons emitted arrive at the plate. When this finally happens, the curve, as before, bends over until nearly horizontal.

¹ The law giving the number of electrons emitted per second as it depends upon the temperature of the filament was first given by O. W. Richardson, whose book, *The Emission of Electricity from Hot Bodies* (1916), describes his experiments in detail. See, also, I. Langmuir, *Physical Review*, vol. 2, p. 450, 1913; and S. Dushman, *General Electric Review*, vol. 18, p. 156, 1915; and W. H. Eccles, *Continuous-Wave Wireless Telegraphy* (1921).

Effect of Filament Temperature.—Suppose now that the voltage of the plate battery (*B*, Fig. 253) is kept at a constant value V_1 and the filament temperature is gradually raised by increasing the current from the filament-heating battery. The number of electrons sent out will continue to increase as the temperature rises. The electric field intensity (Sec. 33) due to the presence of the negative electrons in the space between filament and plate may at last equal and neutralize that due to the positive potential of the plate, so that there is no force acting on the electrons near the filament. This effect of the electrons in the space is called the "space charge effect." It must not be supposed that the space charge effect is caused by the same electrons all the time. Electrons near the plate are constantly entering it, but new electrons emitted by the filament are entering the space, so that the total number between filament and plate remains constant at a given temperature. After the temperature of the filament has reached a point where the effect of the electrons present in the space between filament and plate neutralizes the effect of the plate voltage, any further increase of the filament temperature is unable to cause an increase of the current. The tendency of the filament to emit more electrons per second, because of the increased temperature, is offset by the increase in space charge effect which would result if electrons were emitted more rapidly, or, more exactly, for any extra electrons emitted, an equal number of those in the space are repelled back into the filament. If now the plate voltage is increased to a new value, V_2 , the plate-current curve will rise higher before bending over as shown by the dotted portion of the curve in Fig. 255, because it takes a larger space charge to offset the effect of the plate at the higher voltage.

190. **The Three-Electrode Electron Tube.**—Between the filament and plate of a tube we may insert another piece of metal. This third electrode interposed in the stream of electrons between filament and grid is usually in the form of a metallic gauze or a grid of fine wires, and is generally called the "grid." A tube which contains a filament, plate, and grid is called a three-electrode tube and is capable of many more uses than the two-electrode tube. Fig. 256 shows the construction of a

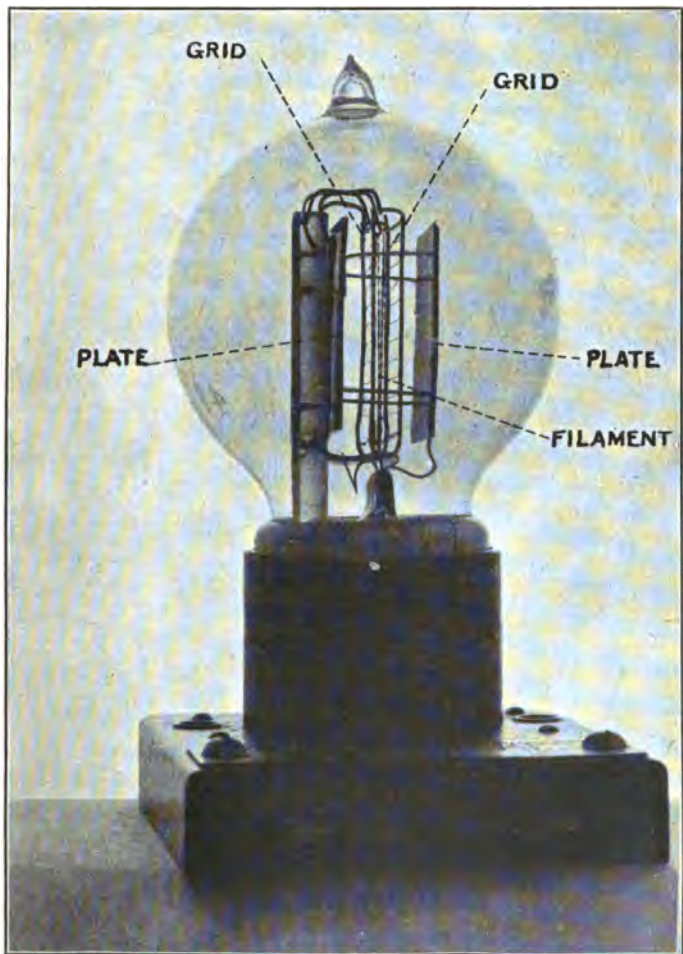

FIG. 256.—Construction of the three-electrode electron tube.

three-electrode tube of American manufacture. The addition of the third electrode makes it possible to increase or decrease the current between plate and filament through wide limits. If a voltage is impressed upon the grid by means of a third battery connected between the filament and grid, shown at *C* in Fig. 257, the space charge effect will be modified. The electrons traveling from filament to plate pass between the wires forming the grid. If the grid is given a potential which is negative with respect to the filament the grid will repel the electrons, but

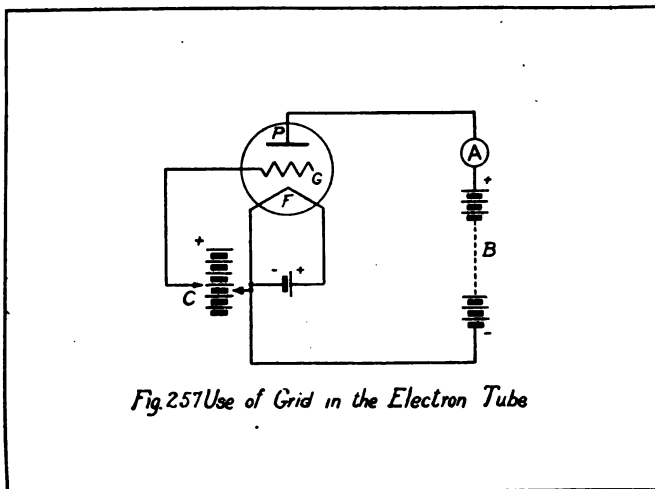

Fig. 257 Use of Grid in the Electron Tube

many of them will still pass through, and reach the plate, because of their high velocity, because the positive plate potential still affects them to some extent. If the grid potential is made still more negative the plate current will diminish until finally it may be stopped entirely.

Suppose, however, that the grid is given a positive potential instead of negative. Electrons are now attracted to the grid as well as to the plate, and more electrons are now drawn toward the plate than would otherwise pass, so that the plate current increases. The charge of the grid partially neutralizes the effect of the space charge. As in the two-electrode tube, a limit

to the magnitude of the plate current will finally be reached, when the space charge caused by the large number of negative electrons in the tube fully counteracts the influence of the positive charges on grid and plate. The attainment of the limiting or *saturation* value of the plate current is assisted by the absorption of more electrons into the grid if its positive potential is increased. This absorption gives rise to a relatively small current in the circuit *FGCF* (Fig. 257), which is called the grid current. The total electron flow is the sum of the plate current and the grid current. As the potential of the grid is made more and more positive, more and more electrons will be absorbed by the grid. The action of the three-electrode tube in its various applications is discussed in detail in the following sections.

For an extensive treatise on the electron tube the reader is referred to a book by Dr. H. J. van der Bijl, *The Thermionic Vacuum Tube and Its Applications*. Another excellent book, which gives somewhat more attention to the practical applications of the electron tube, is volume 2 of a *Text Book on Wireless Telegraphy*, by Rupert Stanley. A treatise of some theoretical aspects of electron tubes is found in a book by W. H. Eccles, *Continuous-Wave Wireless Telegraphy*. A recent comprehensive treatise of electron tubes and electron-tube apparatus is "*Thermionic Tubes in Radio Telegraphy*," by John Scott-Taggart.

191. Characteristic Curves.—In applying electron tubes for different purposes in radio communication the performance is studied in terms of characteristic curves. In simple electrical devices, as an ordinary ohmic resistance, what will happen when the device is used with other equipment can be determined, if at all, from knowledge of only the one property of the device—its ohmic resistance. With electron tubes it is necessary to use diagrams from which all possible combinations of voltages and currents that will occur in practice may be determined.

These diagrams, known as characteristic curves, are easily obtained experimentally by keeping the filament-heating current constant and applying various known voltages between the plate and the filament and between the grid and the filament and reading the resulting currents that flow to the plate and grid. Fig. 258 shows how the characteristics may be determined

with direct-current instruments. Potential dividers P_1 and P_2 may be used to adjust the values of plate voltage e_p and grid voltage e_g to desired values. The currents are then read by the milliammeters i_p and i_g . Correction for the resistance of the milliammeters may be made to determine the true voltage between the cold electrodes and filament if a high order of accuracy is desired, but this correction is usually negligible.

Two diagrams are required to express the relations on a plane sheet. One shows how the plate current depends upon the plate and grid voltages and the other how the grid current depends upon the plate and grid voltages. Fig. 259 shows plate char-

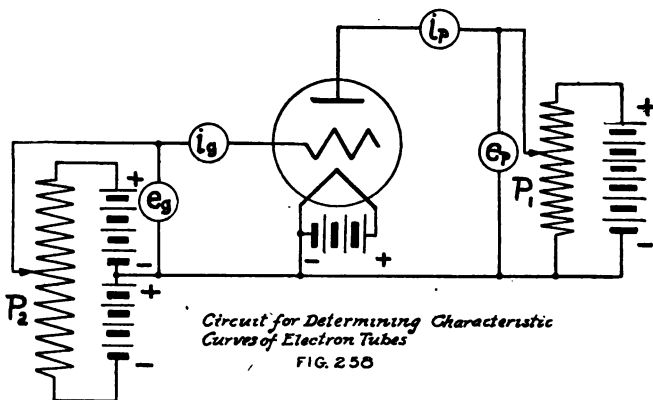

Circuit for Determining Characteristic Curves of Electron Tubes
FIG. 259

acteristics for a tube used in receiving equipment, this being obtained (see Fig. 258) by setting the plate voltage at 20, 40, 60 volts in turn and finding how the plate current changes as the grid voltage is changed. Fig. 260 shows the grid current determined under the same conditions. An alternate method of expressing characteristics is shown in Figs. 261 and 262.

Amplification Coefficient.—These curves may be used to illustrate the phenomena mentioned above in regard to tube action. For example, a change of grid voltage by one or two units causes as great change of plate current as would a change of plate voltage by five or ten units. The amplification coefficient of a tube expresses the relative effects of grid voltage and plate voltage in influencing the plate current. It may be de-

terminated roughly by the use of the equipment shown in Fig. 258, using the following procedure. By means of the potential dividers, adjust e_p and e_g to the point for which the amplification coefficient is desired, as, for example, $e_p=40$ volts, $e_g=0$, and read the plate current, say $i_p=3.00$ milliamperes. Now increase e_g by 0.2 volt, for example, and decrease the plate

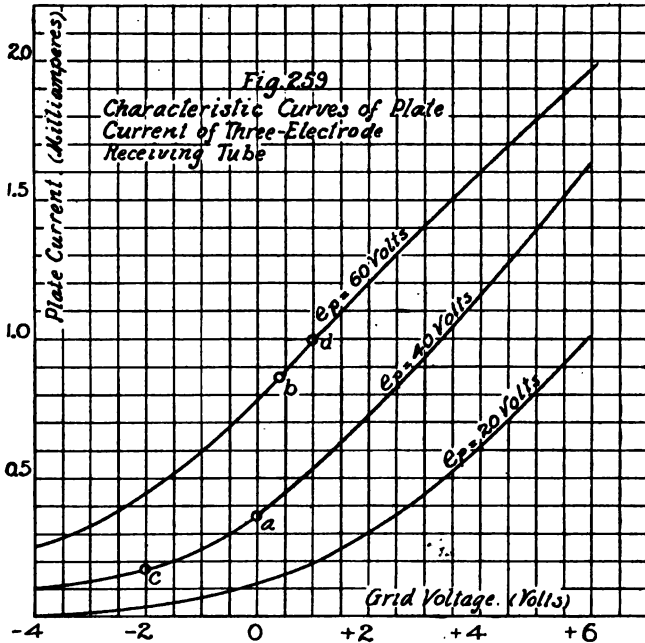

voltage e_p until the plate current is the same as before. Suppose the new setting gives a plate voltage $e_p=38$ volts. Then the amplification coefficient of the tube is the change of plate voltage divided by the change of grid voltage, the plate current being held fixed. For this example, the amplification coefficient $\mu=10$ —that is, the grid voltage exerts 10 times as much influence upon the plate current as does the plate voltage itself, at this particular point on the characteristic.

Internal Resistance.—Another coefficient of importance is the internal resistance of the tube, which is measured by the effect in changing the plate current of the plate voltage alone. Thus, in the above experiment, let the grid voltage e_g be fixed at zero. Change the plate voltage by a small amount, five volts, for example, and read the change in plate current, say 0.5 milliamperes. Then the ratio of voltage change to current change, keeping the grid voltage fixed, is the internal output resistance of the tube. In this experiment the value is 10,000 ohms.

These two coefficients determine how the apparatus connected in the plate or output side of the tube will behave when the grid voltage is changed. Other coefficients are necessary to determine how much power is required for producing the grid voltage changes, so that a knowledge may be had of how the tube reacts upon the apparatus to which the input or grid side is connected.

Power Amplification Coefficient.—By operating the grid at a low or negative voltage, the input power required to produce the changes in grid voltage may be made exceedingly small compared with the output power of the tube. The output power is obtained from the plate battery. The ratio of plate output power to the grid input power is known as the power amplification coefficient of the device, and may be as high as 10,000. This ratio can not be infinite because grid current always exists, even at highly negative grid voltages, and the ratio of plate output power to grid input power could become infinite only if the grid current should be zero.

The Tube as a Variable Resistance.—An alternate method of expressing characteristics is by plotting the volt-ampere relations of each electrode by itself—that is, in Fig. 258, to obtain the volt-ampere characteristics of the plate circuit, fix the grid voltage at a given value, and determine all possible relations between plate volts and plate current. These relations for a tube used in transmitting equipment are shown in Fig. 261, using grid voltages from -40 to $+50$ by steps of 10. From these diagrams it is seen that a three-electrode tube may be thought of as a variable resistance, the setting of which depends upon the grid voltage. The higher the grid voltage, the less is the resistance, and vice versa. For low grid voltages on this diagram the resistance changes with plate current in a manner

similar to a carbon lamp, the resistance of which goes down as the lamp heats up. At high grid voltages it changes as does a metallic filament lamp, the resistance of which increases with

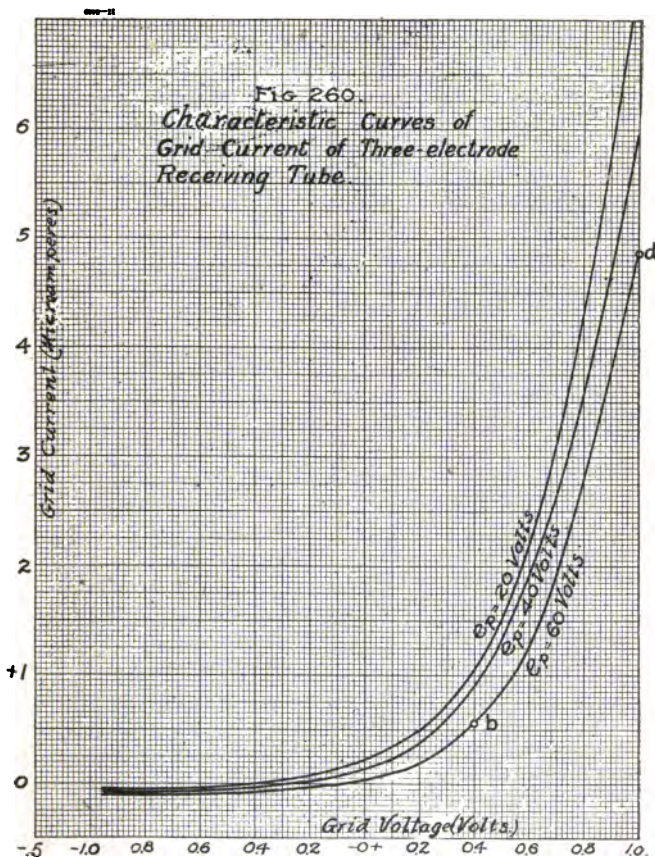

increasing current. This conception of a tube is very helpful in studying its operation, especially in transmitting equipment.

The resistance of the tube can not be changed without the dissipation of power in the grid-filament circuit. The amount

of input power which is thus dissipated and must be supplied is always very much less than the power output which is liberated by the change in resistance. This small input power which is required to control the resistance can be calculated from the characteristic curve showing the relations between the current and the voltage in the input circuit, or grid-filament circuit. These characteristics, which are shown in Fig. 262, are obtained in a manner similar to that employed for obtaining the characteristics of the plate circuit, by keeping the other cold electrode, in this case the plate, at a fixed voltage, and determining the relations between the grid current and the grid voltage.

The grid characteristics are usually plotted to a larger scale than the plate characteristics, because grid voltages and currents are small compared with plate voltages and currents. In a transformer, if the secondary or output voltage is higher than the primary voltage, then the secondary current is lower than the primary current (Sec. 58, page 128). An electron tube differs from a transformer in that the output currents and voltages are both larger than the input currents and voltages. It must be remembered that the law of conservation of energy is not violated, since the output power is derived from the plate battery, which is a part of the output circuit, and is not derived from the grid input power.

Another lack of symmetry between the action of the plate and grid electrodes is that while increasing grid voltage tends to increase the plate current, an increasing plate voltage tends to decrease the relatively small grid current.

192. Operating Characteristics.—While the characteristic curves determine what relations can possibly exist between voltages and currents, the values which do exist between them when the tube is operating in any of its applications is determined by the characteristics of the apparatus used with the tube as well as by the characteristics of the tube itself. For example, if in Figure 263 a resistance R is inserted in the plate lead, in series with the plate battery E_b , then the only values of e_p and i_p which can exist when the tube is operating are given by the equation $e_p = E_b - Ri_p$, where E_b and R express the characteristics of the equipment used in connection with the plate or output side of the tube. On the plate diagram the dotted line

shows what values of plate current and voltage can exist with a resistance of 5000 ohms and a plate battery of 300 volts

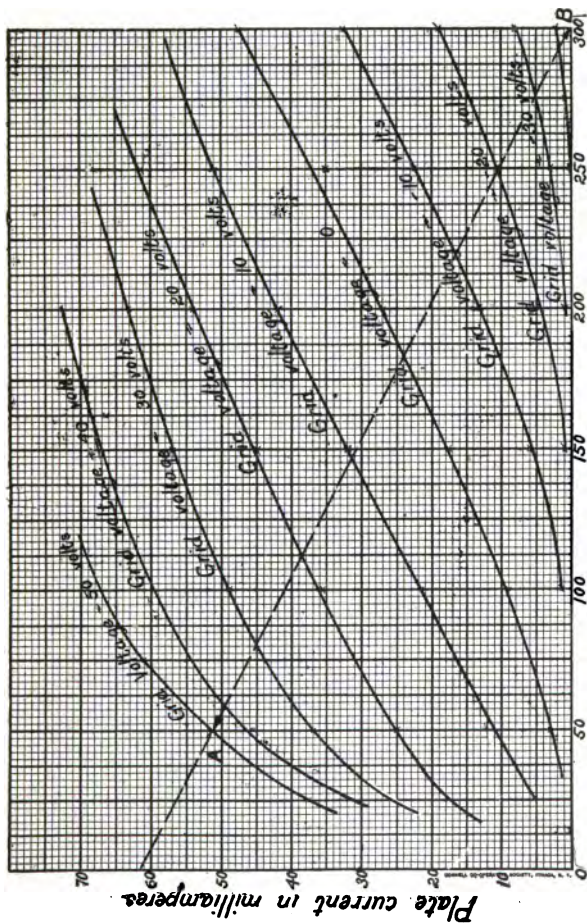
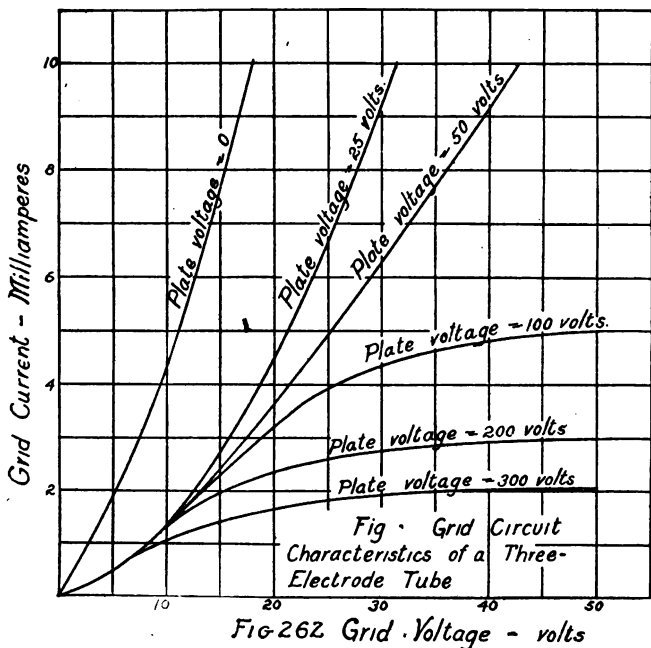

Plate voltage - volts.
 Fig. 261. Plate Characteristic of a Three-Electrode Tube

externally placed between the filament and plate of the tube. If the grid voltage, for example, is -10, then the plate voltage will be 220 volts and the plate current 16 milliamperes, as de-

terminated in Fig. 261 by the intersection of the dotted line and the curve marked "Grid voltage = -10." In other words, these values are both consistent with the tube characteristics, and the characteristics of the external plate battery and resistance. The grid voltage and plate voltage also determine the grid current, so that if the instantaneous grid voltage is



known, then all the other quantities are determined by the tube characteristics.

Thus, if the grid voltage at any instant can be found from the equation $e_g = -10 + 60 \sin \omega t$ —that is, if a sine wave voltage is impressed upon the grid, between limits of -70 and +50 volts—then the wave forms of plate voltage and plate current and grid current for the particular output circuit of Fig. 263 are readily determined to be as shown in Fig. 264. The dotted

line between the terminal points *A* and *B* (Fig. 261) corresponding to the maximum and minimum grid voltages is known as the oscillation characteristic.

It will be noted in the tube operation that when any external impedance is present in the plate circuit the plate voltage is low when the other quantities—the plate current, grid voltage, and grid current—are high. This relation holds whenever the

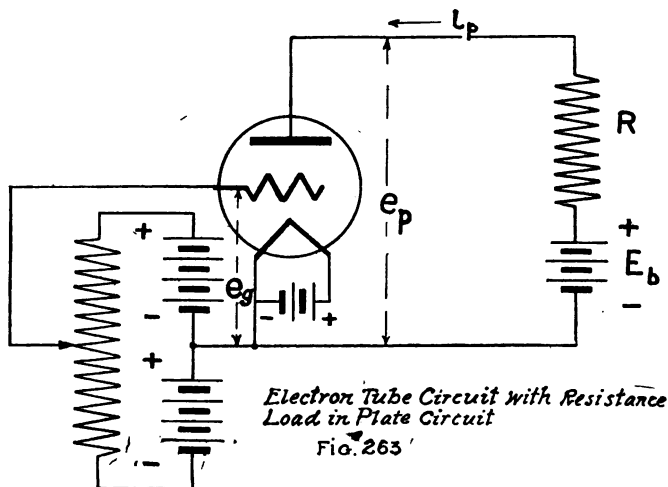

tube is used for producing a magnified output, whether the tube is used as a detector, amplifier, generator, or modulator. In receiving tubes the variations of tube quantities are small compared with average values, but in transmitting tubes they are large.

The case shown with a pure resistance load in the plate branch is the simplest possible case. If there are condensers, inductances, or antennas connected in the output side of the tube, the volt-ampere characteristic of the load is usually a very complicated relation, and the tube operation can not be accurately computed by simple methods. The line of operation or oscillation characteristic will not be a straight line and the wave forms of the plate voltage and plate current will not be

of similar appearance. However, the general relation that the plate voltage will be low when the plate current and grid voltage are high will hold whenever the tube is producing alternating power in the output side.

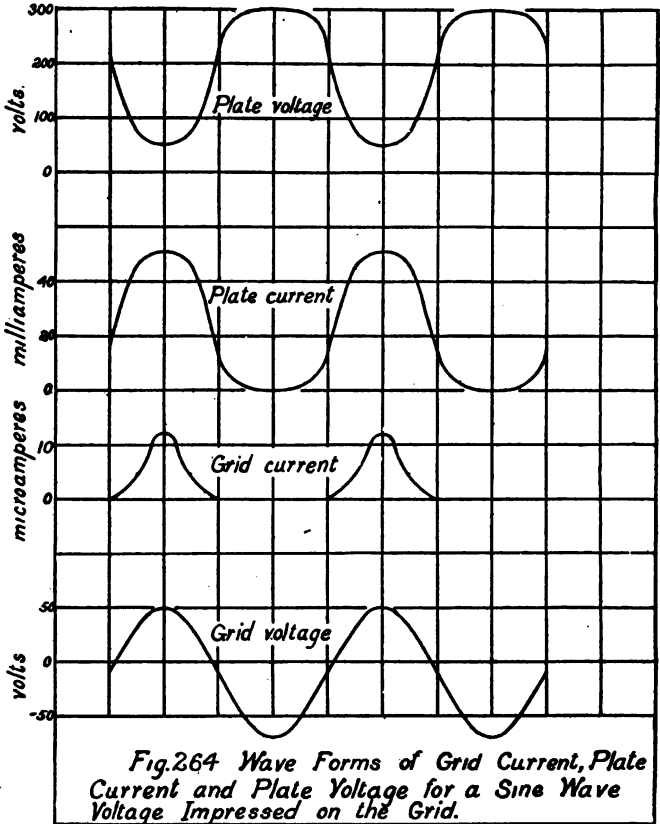

In power applications of tubes the oscillation characteristic is restricted to certain regions. The plate current drawn from the plate battery by a tube is given by the average tube current, and the plate battery voltage is approximately the average

plate voltage. Too high plate voltages and currents can not be used, because the plates of the tube will become very hot and may be destroyed. Tubes used as generators automatically limit themselves to certain regions of the characteristic on account of the high grid current drawn when the plate voltage becomes low.

193. Practical Forms of Three-Electrode Tubes.—In Figs. 265 and 266 are shown a number of American and foreign tubes. In Fig. 265 the tubes numbered 1 to 5 are some of the smaller types of American transmitting tubes. Tube No. 1 is made by the Western Electric Co. and designated by the Signal Corps as Type VT-2; it has a filament coated with oxides, such as those of barium, calcium, or thorium, for the purpose of increasing the electron emission from the filament, and is rated at about 5-watts output. Tubes Nos. 2, 3, 4 are made by the General Electric Co., have pure (uncoated) tungsten filaments, and are rated at about 5-watts output; No. 2 is designated as Type VT-14, and Nos. 3 and 4 are two different forms of Type VT-16, Tube No. 5 is a more powerful General Electric tube designated as Type VT-18 or Type U, and is rated at about 50-watts output.

The tubes numbered 8 to 15 are American receiving tubes, which are also used for amplifying. Tubes Nos. 8 and 9 are made by the Western Electric Co., have coated filaments, and are designated, respectively, Type VT-1 and Type VT-3. Nos. 10 and 11 are made by the General Electric Co., have uncoated tungsten filaments, and are designated, respectively, as Type VT-11 and Type VT-13. Tube No. 12 is made by the De Forest Radio Telephone and Telegraph Co. and is designated as Type VT-21. Tube No. 13 is made by the Moorehead Laboratories and is extensively used. Tube No. 14 is made by the Connecticut Telephone and Electric Co. and has a plate outside of the glass tube in which the filament and grid are contained, the electron flow to the plate occurring through the glass. Tube No. 15 is a very small tube made by the Western Electric Co. and is designated as Type VT-5, or Type N.

Tubes Nos. 16, 17, 18, 19 are French tubes. Tubes Nos. 16, 17, 18 are intended primarily for receiving, but are also used to some extent for transmitting. Tube No. 16, which has two projections at the top, is designed primarily for apparatus in-

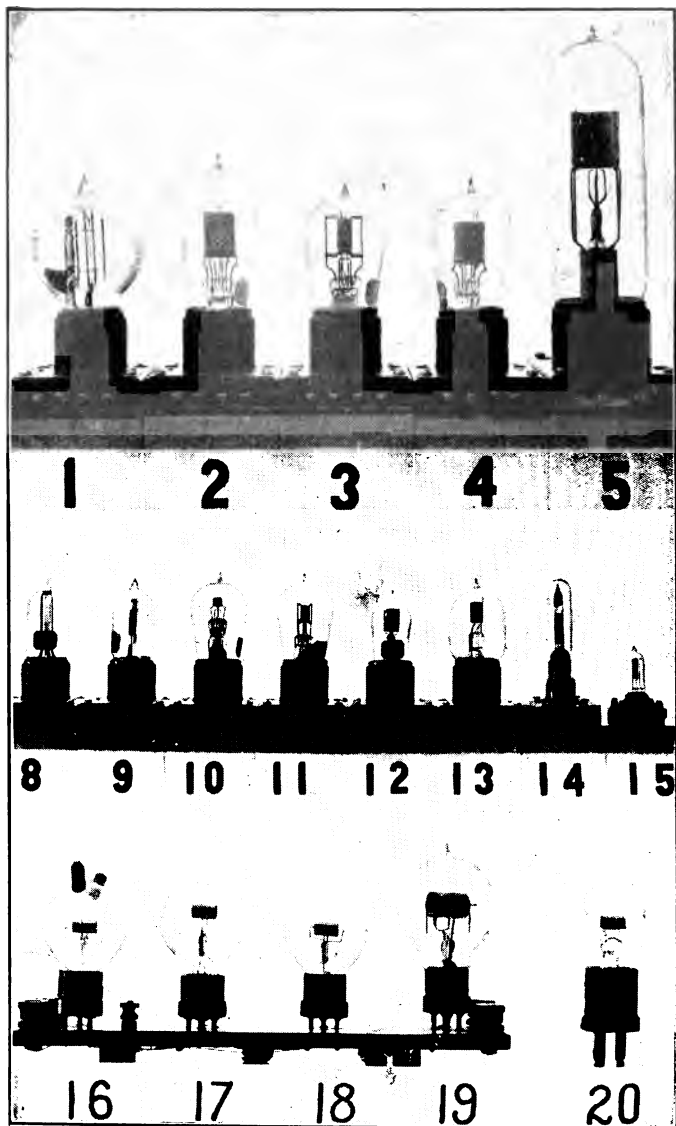

FIG. 265.—Practical forms of three-electrode electron tubes.
470

tended to operate on short wave lengths, the idea of the construction being to keep the connections to the grid and plate

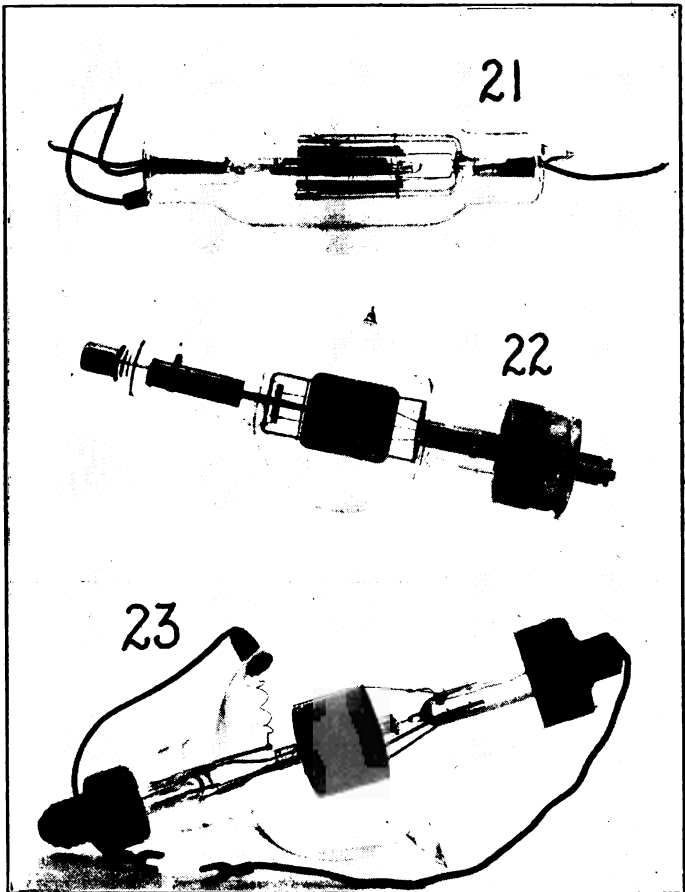

FIG. 266.—Large transmitting tubes.

as widely separated as possible to minimize the capacity between them. In all these French tubes the filament is straight, the grid is a spiral wire surrounding the filament, and the plate

is a cylinder surrounding both. Tubes Nos. 17 and 18 are receiving and amplifying tubes for general service and are made by different manufacturers. Tube No. 19 is designed primarily for transmitting and has an output of about 40 watts. Tube No. 20 is a "Telefunken" German receiving tube, which is similar to the French receiving tubes.

In Fig. 266 tubes Nos. 21, 22, 23 are larger transmitting tubes. No. 21 is an American tube made by the De Forest Radio Telephone and Telegraph Co., and is called by that company an "oscillon"; it has a power output of about 100 watts. Tube No. 22 is an American tube made by the General Electric Co. and called by them a "Type P Pilotron"; it has a rated output of 250 watts. In Tube No. 22 the plates as well as the filament are made of tungsten and the plates are stamped with concentric rings to prevent buckling under extreme heat. A modified form of this tube, called the "UV-204," having a thicker filament and operating at a lower filament voltage, has recently been placed on the market. Tube No. 23 is a British transmitting tube made by the Edison-Swan Electric Co. and designated as Type ES-9; it has an output of about 250 watts. This tube is equipped with an Edison screw base, through which the filament connections are made.

The over-all length unmounted of tube No. 1 is about 4 inches; tube No. 5, 7 inches; tube No. 13, 4 inches; tube No. 15, 2 inches; tube No. 18, 4 inches; tube No. 22, 14 inches.

The present tendency is to make receiving tubes somewhat smaller than heretofore. This is illustrated in tube No. 15, having an over-all length of only 2 inches and very small elements.

B. The Electron Tube as a Detector.

194. Detector Action.—There are two methods of using an electron tube as a detector: First, the use of the properties of the tube when worked at the curved portion of the curve showing the relations of grid voltage and plate current (Fig. 259), and, second, the use of the properties of the tube when worked at the curved portion of the curve showing the relations of grid voltage and grid current (Fig. 260).

In the first method the detector tube is connected directly across the condenser in the receiving circuit (Fig. 267). Suppose

the receiving antenna picks up a signal. Then oscillations in the tuned circuit LC are set up and the radio-frequency alternating voltage across the condenser C_1 is impressed between the grid and filament, bringing about changes in the plate current. If the plate current is normally at a point on the bend of the characteristic curve—say in the region a to c , Fig. 259—the increase of plate current when the grid voltage is positive is greater than the decrease of plate current when the grid voltage is negative. Thus, on the average, the plate current is increased while the oscillations due to the signal last. In Fig. 268 are shown, roughly, the form of (1) the high-frequency oscillations impressed upon the grid, (2) the high-frequency variations in plate current, (3) the audio-frequency fluctuations of telephone current. The frequency with which these telephone fluctuations occur in the frequency of the incoming wave trains and in order to be heard must be within the range of audible sound. The radio-frequency fluctuations which occur in the plate current shown in (2) do not pass through the windings of the telephone receivers, because the inductance of the coils in the telephone receiver is so great that the radio-frequency variations in the plate current can not flow through them, but flow through the capacity existing between the leads and windings and across the by-pass condenser. Thus these radio-frequency variations are by-passed by this effective capacity of the leads of the telephone receiver and only the average current flows through the inductance of the telephone receiver windings (3). When using this method of detection, no current flows in the grid circuit because the average value of the grid voltage is maintained negative with respect to the filament in order to operate on the curved portion of the curve showing the relation between plate current and grid voltage.

With simple detector action of the kind here described, when signals of ordinary intensity are being received, the mean value of the change of the plate current, for a given operating point on the grid voltage-plate current curve, is very nearly proportional to the square of the amplitude of the voltage oscillations impressed on the grid. For very strong signals, however, this relation does not hold. This is a relation which holds for any detector which operates by virtue of the curva-

ture of the curve showing the current which it delivers for various impressed voltages.

In some cases it is necessary to use an additional battery, called a "C" battery, between points *f* and *g* (Fig. 267) in order to bring the plate current to the bend of the characteristic curve (Fig. 259). This, however, does not change the action; the variations of the plate current are brought about by the alternating emf. between the terminals of the coil *L* just as when the battery *C* is absent. It is interesting to note here that we are employing resonance in the circuit LC_1 to obtain as large an emf. as possible between the terminals of the coil and condenser with a given signal. (See Sec. 109.)

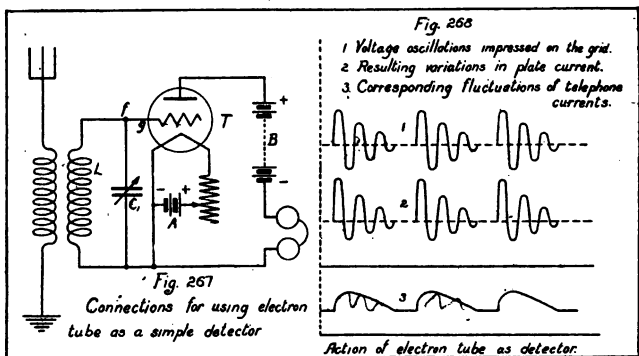

If the grid battery voltage is adjusted so that the plate current has a value near the upper bend of the curve showing plate current plotted against grid voltage, instead of near the lower bend, the action will be essentially the same, but the effect of the arrival of a wave train will be to decrease momentarily the plate current instead of to increase it. As before, there will be fluctuations of the plate current keeping time with the arrival of wave trains, and there will be a sound in the telephone of a pitch corresponding to the number of wave trains per second.

Care must be taken in the use of receiving tubes that the plate battery voltage is never high enough to cause the visible "blue glow" referred to in Section 188. The tube becomes very

erratic in behavior when in this condition and is very uncertain and is not sensitive as a receiver. This is because the plate current becomes so large that it is unaffected by variations of the grid voltage. Characteristic curves will not repeat themselves if the tube shows the blue glow, and sharp breaks may appear in any or all of the curves. Furthermore, the electrodes are heated and may be damaged by the blue-glow discharge.

Condenser in Grid Lead.—With many tubes louder signals are obtained if the grid is made positive with respect to the nega-

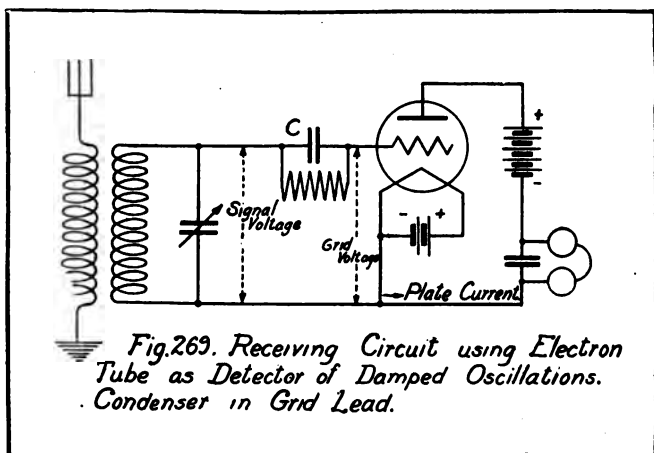
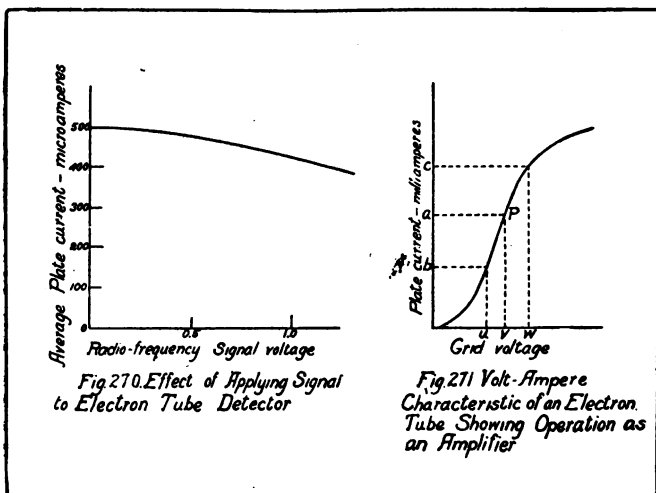

Fig. 269. Receiving Circuit using Electron Tube as Detector of Damped Oscillations. Condenser in Grid Lead.

tive end of the filament, so that current flows in the grid circuit. Instead of operating on the curved portion of the grid-voltage, plate-current curve the tube operates upon the curved portion of the grid-voltage, grid-current curve and the straight portion of the grid-voltage, plate-current curve (see Fig. 272). When using the curvature of the grid-current characteristic in this fashion, a condenser is connected in series with the detector tube and with the receiving circuit from which the signal voltage is obtained (C in Fig. 269). Now suppose that a series of wave trains falls upon the antenna of Fig. 269, as shown in (1) of Fig. 272. If the circuit LC is tuned to the same wave length as the antenna circuit, oscillations will be

set up in it and similar voltage oscillations will be communicated to the grid by means of the condenser *C*. As shown in (2), Fig. 272, each time the grid becomes positive the electron current which flows at the voltage e_0 will be increased more than it is decreased when the grid voltage goes below e_0 . Thus during each wave train the grid will continue gaining negative charge and its voltage will, on the average, be mostly negative, as shown in (3), Fig. 272. This negative charge on the



grid opposes the flow of electrons from filament to plate and produces a much magnified decrease in the plate current throughout the train of oscillations, as shown in (4), Fig. 272. At the end of each wave train this charge leaks off either through the condenser or through the walls of the tube, or both, and the plate current becomes steady again at its normal value (4), Fig. 272. This should happen before the next wave train comes along, and in order to insure this a resistance of about a megohm (a million ohms) is shunted across the condenser. Such a resistance is called a "grid leak." As has been stated above, the inductance of the coils in the telephone

receivers is so great that the radio-frequency variations in the plate current can not flow through them, but flow through the capacity existing between the leads and windings and across the by-pass condenser. The current which actually flows through the windings and operates the telephone receivers, if drawn, will look something like the dotted line in (4) and the heavy line in (5). Thus, as in the case of the circuit of Fig. 267, the note heard in the telephone corresponds in pitch to the frequency of the wave trains. If the waves falling upon the antenna are undamped waves, they may be detected using either of these circuits if they are first divided off into audio-frequency groups. (For methods see Sec. 181, p. 430, and Sec. 211, p. 529.) To receive undamped waves which are not divided into groups of audible frequency, electron tubes may be used in special ways called the heterodyne and the autodyne methods. (See Sec. 205, p. 501.)

195. Experimental Data on Detectors.—The decrease in plate current in a detector tube with grid condenser and grid leak which takes place when a radio wave train is applied to the grid can be shown experimentally. In Fig. 270 is shown the average plate current in microamperes as it varies with increasing radio-frequency voltage applied to the grid condenser in a circuit such as that of Fig. 269. The tube used here is a receiving tube, Signal Corps Type VT-1. At zero, or no incoming signal voltage, the plate current is 500 microamperes, corresponding to the point *P* in Fig. 272. As the amplitude of the oscillations in grid voltage is increased to 0.5 volts, the plate current decreases to 480 microamperes, then to 420 microamperes at 1.0 volt, etc. This curve was taken with a condenser (*C* in Fig. 269) of 250 micromicrofarads and a leak resistance of 2 megohms. The operating point, or steady grid voltage, about which the potential of the grid was caused to oscillate by the incoming signal, was +0.8 volts, corresponding to the point *e*₀ in Fig. 272.

The tubes generally supplied to the Signal Corps for receiving (types VT-1, VT-11, VT-21) operate best with a leak resistance of 2 megohms and with the return connection made from the grid condenser through the receiving circuit to the positive side of the filament. Owing to the flow of the steady grid current

through the high leak resistance, this fixes the steady voltage of the grid at about 0.5 to 0.8 volts positive with respect to the negative end of the filament.

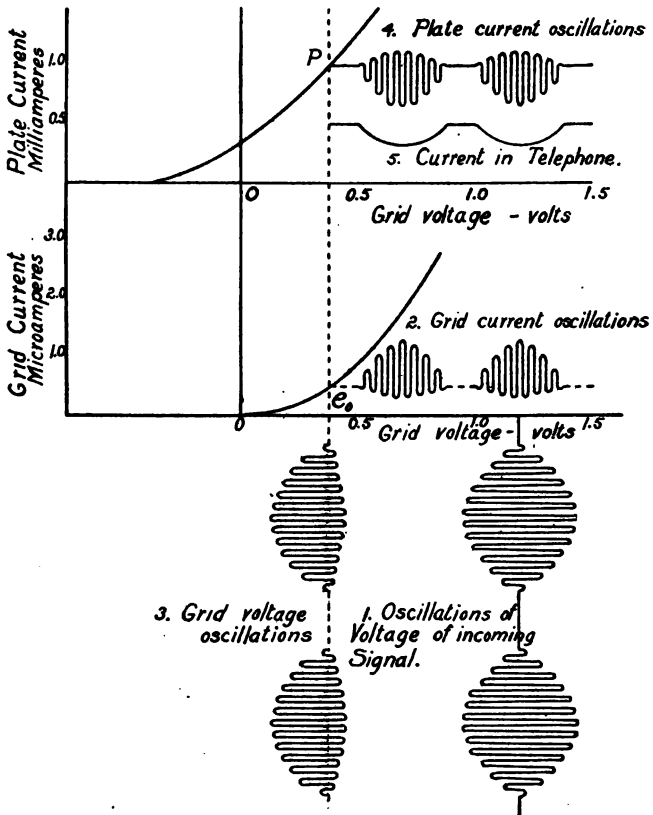

Fig. 272. Action of Detector Tube in Reception Using Grid Condenser.

In order to get a readable signal from a good tube detector, it is usually necessary to apply to the grid a voltage of two millivolts effective value, which would correspond approxi-

mately to an alternating current of about 0.01 microampere in the grid circuit. These values apply to a completely modulated wave—that is, a wave whose oscillations reach a zero value at regular intervals which correspond to the audio frequency of the wave trains.

C. The Electron Tube as an Amplifier.

196. General Principle of Amplification.—It was shown in Section 194 that an electron tube acts as a detector or rectifier because an alternating voltage applied to the grid circuit can be made to produce unsymmetrical oscillations in the plate circuit. While the tube is thus acting as a detector it is also, as a matter of fact, acting as an amplifier—that is, oscillations of greater power are produced in the plate circuit for a given alternating voltage in the grid circuit than would be produced by the same voltage directly in the plate circuit. This explains why the electron tube may be a more sensitive detector than the crystal detector, which acts as a rectifier only.

It is sometimes desired to amplify an alternating current without any rectifying or detecting action. This is done by keeping a voltage on the grid of such value that the symmetry of the oscillations in the plate circuit is not altered. Thus, if there is a steady voltage applied on the grid of such value that the plate current is on the part of the characteristic curve that is nearly straight (as point *P* in Fig. 271), then a small change in grid voltage in either direction causes the plate current to increase or decrease the same amount. For instance, if the grid voltage is increased from *v* to *w* (Fig. 271) or decreased by an equal amount from *v* to *u*, the current will, in the first case, increase from *a* to *c* and in the second case fall off by an equal amount, from *a* to *b*. In other words, the wave form of the grid voltage variation will be repeated in the fluctuating plate current. The latter will now be equivalent to an alternating current superimposed upon the steady plate current from the plate battery. The magnitude of the alternating-current part of the plate current will be greater, the steeper the slope of the curve at the point *P*.

For the same voltage acting in the two circuits the power expended in maintaining the oscillations of the grid current is

far less than that involved in the corresponding variations in the plate current. For example, referring to the electron tube whose characteristic curves are given in Fig. 260, if the plate voltage is maintained constant at 60 volts and the grid voltage oscillates, so that the plate current varies between the values b and d , the grid current will change from about 0.57 to 4.85 microamperes, and the average voltage on the grid is 0.7 volt. The corresponding change in plate current is from 862 to 1000 microamperes. Since the power in watts in any circuit is the product of the amperes by the volts effective in the circuit, we have in the grid circuit a power expenditure of $(4.85-0.57) \times 0.7=3.00$ microwatts, and in the plate circuit a corresponding power change of $(1000-862) \times 60=8280$ microwatts. This magnified power is drawn from the energy delivered by the plate battery. The signals may be thought of as exerting a sort of relay action on the plate circuit, causing magnified power to be drawn from the plate battery. The tube is said in this case to act as an "amplifier." The variations of current in the grid circuit have been compared to the slide valve of an engine, since they admit energy from the battery into the plate circuit much as the slide valve admits energy into the cylinder of the engine. The oscillations impressed on the grid circuit may be of high radio frequency or of an audible frequency of perhaps 300 to 3000 cycles per second.

To utilize the amplified alternating current in the plate circuit, the primary of a transformer T (Fig. 273) may be placed in the plate circuit. From the secondary of this transformer the alternating current (see Sec. 58) is delivered to a detector, which may be an electron tube operating as a rectifier or a crystal detector. If further amplification is desirable, the alternating current from the secondary of the transformer may be delivered to the grid circuit of a second amplifying tube, as shown in Fig. 273. From this second tube it then goes to a detector tube or to a crystal detector. This method of successively using two or more tubes for amplification is called *cascade amplification*. The last tube in such an amplifier of radio-frequency waves is called the detector tube, and the other tubes are called amplifier tubes. An amplifier consisting of one detector tube and two amplifier tubes is said to have two stages of amplification.

Instead of transferring the amplified energy by means of a transformer coupling, the coupling may be simply a resistance, or may be a condenser. A circuit using resistance coupling is shown in Fig. 274, in which the radio-frequency power is amplified by two tubes coupled together through resistances, and then detected. After passing through the detector, the currents of audio-frequency can be further amplified by one or more audio-frequency stages. An amplifier in which the signal is amplified *before* reaching the detector is called a radio-frequency amplifier. An amplifier in which the signal is amplified *after* passing through the detector is called an audio-frequency amplifier. Resistance couplings in radio-frequency amplifiers have been extensively used in France, but not to so great an extent in the United States. The advantage of a resistance-coupled amplifier is that while the amplification per tube may not be so great as with transformer couplings, the amount of amplification is practically independent of the wave length for long wave lengths. Resistance-coupled amplifiers seldom give full amplification at wave lengths below 1,000 meters. In order to get the greatest power output, and hence the greatest power amplification, from a tube, a resistance should be used in the plate circuit of a value equal to the average internal resistance of the tube between plate and filament. In this respect the tube is similar to any other electrical machine and to a battery, as described in Section 24. Usually, however, such small currents flow into the detector used with radio-frequency amplifier that the detector may be considered a voltage-operated device, in which case the maximum voltage output and not the maximum power output is desired from the amplifier tubes. This is realized by making the coupling resistances larger than the internal resistance of the tube between plate and filament, in some cases two or three times as large. These high resistances require higher plate voltages than are required for transformer coupling, perhaps voltages two or three times as great as for transformer coupling. In some cases, as in some military applications, this may be a real disadvantage. An interesting discussion of resistance-coupled amplifiers is given in the British Admiralty Handbook of Wireless Telegraphy.

For audio-frequency amplification, iron core transformers are used. For transformer-coupled radio-frequency amplification

the small transformers used generally have air cores—that is, no iron is used. There have recently been developed radio-frequency transformers with iron cores, very thin laminations being used.

197. Elementary Theory of Amplification.—The characteristic curves of an electron tube show that an increase in the grid voltage makes a much greater increase in the plate current than the same increase in the plate voltage itself would do. Consider, for instance, the two upper curves of Fig. 259, page 461. From the curve corresponding to a plate voltage of 40 volts we see that the plate current increases from 430 to 530 microamperes when the grid voltage is increased from 0.4 to 1.0 volts, or 167 microamperes per volt change. If, on the other hand, the grid voltage is left unchanged at 0.4 volts, and the plate voltage increased to 60 volts, the upper curve shows that the plate current increases to 862 microamperes, a change of 21.6 microamperes per volt. In other words, a volt added to the grid voltage makes eight times as much change in the plate current as a volt added to the plate voltage would make. This number, which represents the relative effects of grid voltage and plate voltage upon plate current, is called the “amplification coefficient” of the tube.² The greater the value of this amplification coefficient is for a given value of internal plate-circuit resistance of the tube, the more efficient is the tube as an amplifier of weak signals. The amplification coefficient may be defined as the ratio of the change in plate current per volt change on the grid, to the change in plate current per volt change on the plate.

The two principal constants of a tube are the amplification coefficient just defined and the internal output resistance or internal plate-circuit resistance, and these have been discussed in Section 191. The internal plate-circuit resistance is the resistance to small alternating currents which exists between the plate and the filament in the tube, and, since it is the re-

²The theory of amplification has been presented in detail by Langmuir. Proc. Inst. Radio Engineers, 3, 261, 1915; Latour, Electrician, 78, 280, 1916; van der Bijl, Phys. Rev. 12, 171, 1918; van der Bijl, Proc. Inst. Radio Eng., 7, 97, April, 1919; van der Bijl, The Thermionic Vacuum Tube and its Applications.

sistance of the output circuit of the tube, is often called the internal output resistance. These two constants may be

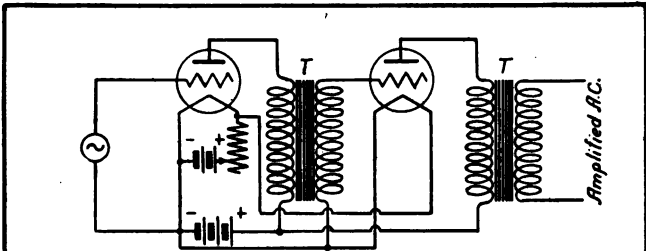

Fig.273.Connections for Cascade Amplification Transformer Coupling.

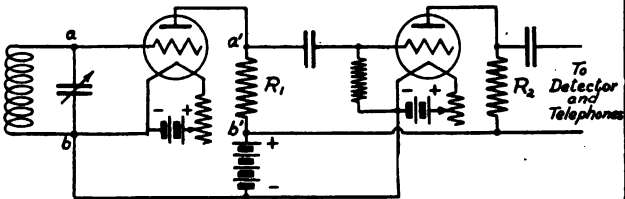

Fig.274.Resistance Coupled Amplifier.

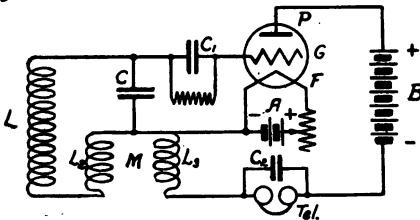

Fig.275.Regenerative Circuit for simultaneous amplifying and rectifying.

calculated from the characteristic curves of the tube or may be measured by a simple method like a bridge measurement or may be calculated approximately from the structural dimensions of

the tube.⁸ The voltage amplification given by an amplifying circuit may be calculated from these two constants of the electron tube.

The voltage amplification may be defined as the ratio of the voltage change produced in the output apparatus in the plate circuit to the change in the voltage impressed on the grid. Thus, in the resistance-coupled amplifier of Fig. 274, it is the ratio of the voltage between a' and b' at the terminals of R to the voltage applied between a and b . Calling the amplification coefficient K and the internal output resistance R_0 it can be shown that the voltage amplification for such a combination is

$$\frac{KR}{R+R_0}$$

198. Audio-Frequency Amplification.—In the preceding discussion of amplification it was pointed out that after a radio-frequency current is amplified it is passed through a rectifying device, often a detector tube, and the term "audio-frequency amplifier" was defined. If an audio-frequency current is to be amplified, it is not necessary to pass the amplified current through a detector, since the amplified current is audible if received with a telephone receiver placed in the plate circuit of the amplifier. It is sometimes desired to amplify the audio-frequency current produced in a radio rectifying device, in which case the amplifier is an audio-frequency amplifier. In this case the radio current consisting of groups of radio-frequency oscillations is first impressed upon the detector and the pulses of current having the group frequency are passed on into the amplifier. The amplifying process may be carried on through several steps, as in the cascade amplification shown in Fig. 273. An amplifier consisting of two Type VT-1 tubes in cascade may give a power amplification of 20,000 times.

In some amplifiers as many as six tubes may be used. In such cases it is general practice to use perhaps three tubes as radio-frequency amplifiers, then the detector tube, and then perhaps two tubes as audio-frequency amplifiers. One reason for using the radio-frequency amplification is because under proper operating conditions with signals of moderate intensity the output

⁸ See Miller, Proc. Inst. Radio Engineers, 6, 141, 1918; Miller, Proc. Inst. Radio Engineers, 8, 64, February, 1920; van der Bijl, Phys. Rev., 12, 171, 1918; R. W. King, Phys. Rev., 15, 256, April, 1920.

of a detector tube is approximately proportional to the square of the input voltage, and hence the output of the detector tube increases rapidly as the input voltage is increased. If more than three stages of radio-frequency amplification are used, troublesome regenerative effects are very likely to occur in the output circuit of the amplifier. Regenerative effects are also likely to occur if more than two stages of audio-frequency amplification are used, causing "howling" noises in the output circuit. If, therefore, we wish to use as many as six tubes in an amplifier, it is necessary to use both radio-frequency and audio-frequency amplification. These troublesome effects can be reduced by properly shielding the various circuits of the amplifier, as by inclosing in metal. If very feeble incoming oscillations are impressed on the input of such a six-tube amplifier of a type now in extensive use, the over-all voltage amplification of the amplifier may be several million. It is only by the use of amplifiers of this type that it has been possible to use the coil antennas, which may be 4 feet square or even smaller, as receiving devices and as radio compasses.

Amplifiers with a large number of tubes have been used, especially for very short waves, such as 50 meters. The use of even six tubes requires very careful design to prevent difficulties due to regenerative effects. With a greater number of tubes and greater amplification every disturbance is magnified, and even greater care in design is essential and shielding is particularly important. The use of more than six tubes in a compact, portable, unit, is especially difficult. A six-tube amplifier, properly designed, will usually give all the amplification necessary for ordinary purposes.

The use of radio-frequency amplification for short wave lengths, particularly for less than 300 meters, is attended with many difficulties caused by the low-impedance paths which the capacities between the leads and between the elements of the tubes offer at high frequencies. For short waves the high frequency may be changed before amplification by the beat method. (See Sec. 205, page 506.)

If an amplifier with transformer coupling or capacitive coupling is to be used on one particular wave length a much more effective amplifier can be designed than if it is required that the amplifier operate over a considerable range of wave lengths.

The performance of a resistance-coupled amplifier, however, when used on long wave lengths depends very little on the wave length. Resistance-coupled amplifiers seldom give full amplification at wave lengths below 1,000 meters.

Adjustment of grid potential.—In discussing contact detectors in Section 182, page 439, the effect of using a “booster” battery for causing the detector to operate on the most desirable part of the characteristic curve was described. A somewhat similar method may be used with tube detectors and amplifiers, although the phenomena involved are by no means as simple as in the case of the contact detector. The grid of a tube may be maintained at a definite voltage above the negative terminal of the filament, so that the tube operates at a particular point on the characteristic curve showing the relation between grid voltage and plate current. For a detector it is desirable to have the operating point at the sharpest bend in the characteristic curve, as has been explained above. For an audio-frequency amplifier it is usually desirable to have the operating point at about the center of the steepest part of the characteristic curve. The d. c. voltage so used is often called a “biasing potential.” The use of a “C” battery for obtaining this biasing voltage has been described in Section 194, page 474. A method of obtaining this biasing potential, which is extensively employed, is by the use of a voltage divider arrangement, which consists of a resistance of perhaps 200 or 300 ohms connected across the filament battery terminals and an adjustable contact, which is connected to the grid.

Stabilizer.—In receiving damped waves or interrupted continuous waves with an amplifier it is necessary to prevent the various tubes in the amplifier from oscillating. This may be done by applying a positive voltage of the proper magnitude to the grid. The voltage divider arrangement just mentioned may be used for this purpose, and when so applied to amplifier tubes is called a “stabilizer.” The stabilizer is usually so adjusted that the circuit of the tube for which it is used is just below the oscillating condition. In an amplifier of several stages, such as the six-tube amplifier mentioned above, having both radio-frequency stages and audio-frequency stages, it is desirable to have one separate stabilizer for the radio-frequency

stages and one stabilizer for the audio-frequency stages. A separate voltage divider should also be used for adjusting the grid potential of the detector tube. The use of the stabilizer makes the grid sufficiently positive so that the grid circuit will absorb an appreciable amount of power. Stabilizers may be used with amplifiers having either inductive, capacitive, or resistance coupling. Stabilizers may greatly increase the sensitivity and usefulness of an amplifier and are now found on many radio-frequency amplifiers of recent design.

199. **Regenerative Amplification.**—The sensitiveness of an electron tube as a detector may be enormously increased by a method which multiplies its amplifying action. The connections are shown in Fig. 275. The explanation of the amplifying action is as follows. Oscillations in the circuit LL_2C applied to the grid through the condenser C_1 produce corresponding variations in the continuous plate current, the energy of which is supplied by the plate battery (B , Fig. 275). This plate current flows through L_3 , and by means of the mutual inductance M some of the energy of the plate oscillations is transferred back to the grid circuit, and the current in the circuit LL_2C is thus increased. This produces amplified grid oscillations which, by means of the grid, produce larger variations in the plate current, thus still further reinforcing the oscillations of the system. Simultaneously with this amplification the regular detecting action goes on; the condenser C_1 is charged in the usual way, but accumulates a charge which is proportional not to the original signal strength but to the final amplitude of the oscillations in the grid circuit. The result is a current in the telephone much greater than would have been obtained from the original oscillations in the circuit.

To obtain maximum voltage on the grid, the circuit LL_2C should have large inductance and small capacity. The connections between L_2 and L_3 must be so made that their mutual inductance is of proper sign to produce an emf, which will aid the oscillations instead of opposing them. Various modifications of this method are used. The condenser C may be across L_3 , so that the tuned oscillatory circuit is in series with the plate instead of the grid; or C may be connected across all of the inductance in series, the oscillation circuit then including L , L_2 , and L_3 .

Combination Radio and Audio Regenerative Amplification.—A single electron tube can be used to amplify and detect radio-frequency current and simultaneously to amplify the telephone pulses of audio frequency. The circuits are shown in Fig. 276. Here M_r represents the coupling for the radio frequency, and the coils are of relatively small inductance. M_a is the coupling for the audio frequency, and the transformer is made up of coils having an inductance of a henry or more. The variable condensers C_r and C_a have the double purpose of tuning M_r to

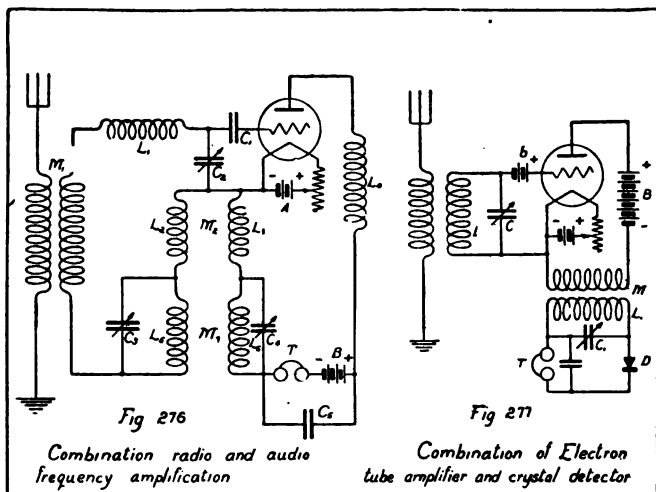

the audio frequency and of by-passing the radio frequencies. The radio-frequency variations in the plate current flow through the circuit $PFL_2C_aC_sL_4$, and at the same time the audio-frequency variations flow through the circuit $PFL_2L_2TBL_4$. The audibility of weak signals received by this method is about 100 times the audibility obtained with a single tube connected in a simple detector circuit. On stronger signals the amplification is smaller.

200. Electron Tube Amplifier with Crystal Detector.—The characteristic curves of an electron tube show that the best value of grid voltage for amplification is not the same as for best

detecting action, which is an argument for using separate tubes for these two purposes. This adds somewhat to the complexity of the apparatus, and in apparatus in which for some reason it is desired to use only one tube the combination of an electron tube for amplifying and a crystal detector for detecting may be used.⁴ Such a circuit is shown in Fig. 277.

The oscillating circuit LC is coupled to the antenna and is tuned to the frequency of the latter, which is the frequency of the incoming waves. The alternations of voltage between the terminals of the coil L are applied between the filament F and the grid G through the battery b , which has been previously adjusted in voltage so that the plate current has a value corresponding to a point on the straight part of its characteristic.

The amplified oscillations in the plate circuit are communicated to the oscillating circuit L_1C_1 , which is coupled to the plate circuit through the coil M . The circuit L_1C_1 is tuned to the frequency of the received waves like the other two circuits. The alternations of voltage between the terminals of the coil L_1 are rectified in the crystal detector D in the usual way and cause an audio-frequency current to flow through the telephone receivers.

For further information regarding the amplifying action of the electron tube and various types of amplifiers, the reader may refer to: H. J. van der Bijl, "The Thermionic Vacuum Tube and Its Applications;" J. H. Morecroft, "Principles of Radio Communication;" John Scott-Taggart, "Thermionic Tubes in Radio Telegraphy;" and the "Admiralty Manual of Wireless Telegraphy."

D. The Electron Tube as a Generator.

201. Conditions for Oscillation.—The electron tube can be made to generate high-frequency currents and thus act as a source of radio current for the transmission of signals and other purposes. Any regenerative circuit, such as that shown in Fig. 275, can be made to generate spontaneous oscillations,

⁴G. Martinez, *L'Elettrotecnica*, 4, 278, May 25, 1917: Science Abstracts B, No. 481, 1917. Other receiving circuits using crystal detector with electron tube amplifier are shown in the books, W. H. Eccles, *Wireless Telegraphy* (2nd ed.), pp. 302-304, and E. E. Bucher, *Vacuum Tubes in Wireless Communication*, pp. 73-75.

if it be so arranged that any change in grid voltage makes a change in plate current of such magnitude that there is induced in the grid circuit a larger voltage than that originally acting. It has already been pointed out that in any electron tube much more power is produced by variations in the current to the plate than must be expended in changing the grid voltage to produce these variations. Thus there are a great variety of

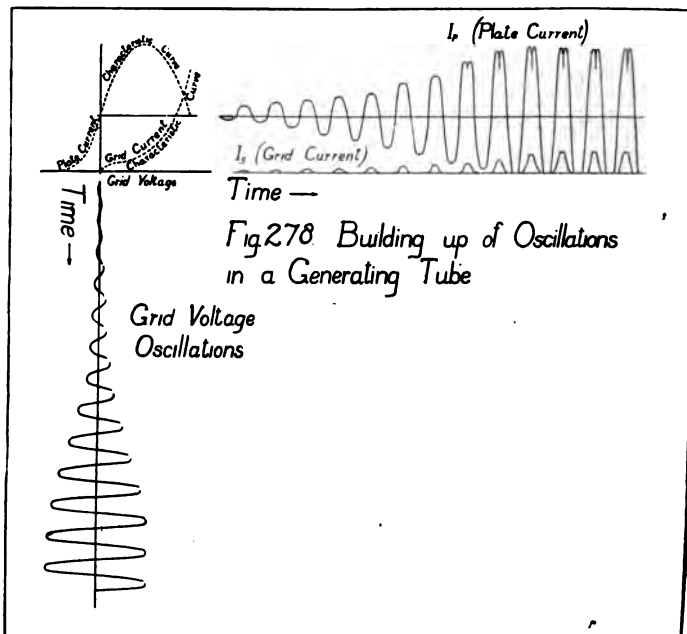

circuits in which the plate circuit is coupled back to the grid circuit in such a manner as to supply this small power to the grid and make the surplus power available for use in an external circuit in the form of continuous or undamped oscillations of any frequency from even less than one per second to 10,000,000 or more per second.

This "feed-back" action can be obtained by the use of direct coupling from the plate back to the grid circuit, by inductive

coupling, or by electrostatic coupling. The only requirement for continuous oscillations is that the voltage induced in the grid circuit must vary the plate current through an amplitude which supplies to the external or coupling circuits power sufficient or more than sufficient to maintain this voltage in the grid circuit. Thus in the circuit shown in Fig. 275 if the mutual inductance M be increased beyond a certain point the pulsating plate current flowing through the coil L_2 will supply enough power through the coupling between L_1 and L_2 to maintain an oscillating current through the condenser circuit LL_2C , which, in turn, varies the grid voltage to produce the changes or oscillations in the plate current. The frequency with which the oscillations of current and voltage occur throughout the whole system is approximately the natural frequency of the LL_2C circuit.

202. Circuits Used for Generating Oscillations.—The circuit shown in Fig. 279 is one which is used quite extensively for transmitting purposes. The capacity and resistance C and R can be replaced by an antenna and ground connection. It is of the inductively coupled type. Any slight disturbance, such as the closing of the plate battery switch, sets up minute oscillations in the closed inductance-capacity circuit. An alternating voltage is induced on the grid by virtue of the mutual inductance M_g . This causes alternations in the plate current of sufficient magnitude to supply through the mutual inductance M_p an emf. in the condenser circuit greater than that already present. Thus the voltage and current oscillations build up, as shown in Fig. 278, until a further increase in grid voltage no longer increases the pulsating plate current owing to the fact that the plate current can neither pass below the zero line nor increase above saturation value. The oscillations are then maintained at constant amplitude, when the power supplied to the oscillatory circuit through the coupling M_p by the pulsating plate current I_p (Fig. 278) is just equal to the power dissipated by the current I_2 (Fig. 279) flowing through the resistance R plus the power expended in the grid circuit by the grid current I_g (Fig. 278). The current I_2 flowing through the output circuit is built up to an amplitude many times greater than that in the plate circuit of the tube.

When this steady state of oscillation is reached the current I_1 can have an amplitude many times greater than that in the plate circuit of the tube. The reason for this follows immediately from the preceding statement regarding the equality of power supplied in the plate circuit and power expended in the output circuit. The power supplied in the plate circuit may be regarded as the product of the square of the plate current I_1 and the effective resistance of the tube between plate and filament during the oscillation, which is negative in sense (since the plate voltage decreases as the plate current increases) and is of the order of magnitude of several thousand ohms. The power dissipated in the output circuit is the product of the square of the output current I_2 and the resistance R , which is usually only a few ohms, possibly ten. Hence when these two values of power balance each other in the steady oscillation the output current I_2 must be considerably larger than the plate current I_1 .

In Fig. 280 is shown a direct-coupled circuit in which the mutual inductance M_p is replaced by the coil L_p and the mutual inductance M_g , by the coil L_g . In Fig. 281 is shown a circuit in which the tube supplies power to the oscillatory circuit by means of the voltage across a condenser C_p and power is extracted by the grid circuit by the voltage across C_g . With this type of circuit the direct-current power furnished by the plate battery or generator is connected in series with a radio-frequency choke coil directly from plate to filament. This is called a "parallel-type" circuit, since the source of direct-current power, the output circuit, and the tube are all in parallel. If it is desired to use this circuit for transmitting, the condenser C_p can be replaced by antenna and ground, the ground being connected to the key side of C_p .

203. Practical Considerations in Using Electron Tubes as Generators.—The useful power output from an oscillating tube is the power expended by the oscillating current I_2 (Fig. 280) in the resistance of the output circuit. The power input to the tube, exclusive of that used in heating the filament, is the product of the plate supply voltage and the *average* plate current during an oscillation. Thus, with the Type VT-2 tube used by the Signal Corps, which may be operated with a plate voltage

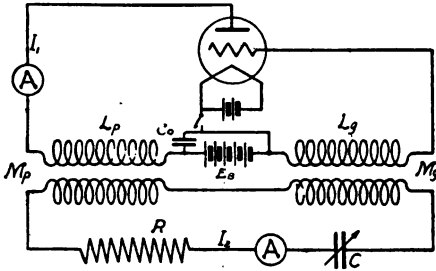

Fig. 279. Electron Tube Generating Circuit Inductive-Coupling.

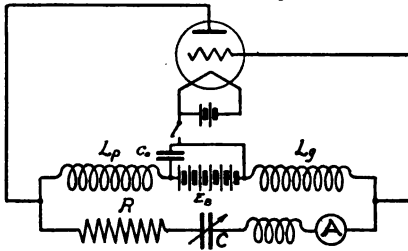

Fig. 280. Electron Tube Generating Circuit Direct Inductive Coupling

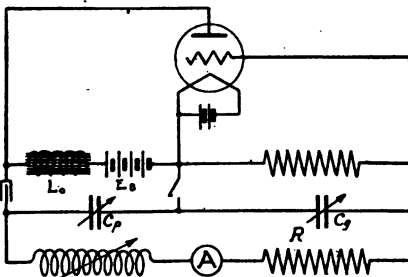

Fig. 281. Electron Tube Generating Circuit Direct Capacitive Coupling

of 300, a direct-current ammeter connected in the plate circuit may read 0.05 amperes while the system oscillates. The power taken by the tube from the plate battery or generator is thus 15 watts. The current I_1 may reach a value of 0.5 ampere effective, through a resistance $R=16$ ohms. Thus the useful power output is 4 watts and the efficiency of conversion of the direct-current power into alternating-current power is 26 per cent. The remainder of the 15 watts is expended in the grid circuit and in heating the plate. Maximum efficiency is seldom obtained in a circuit adjusted for maximum output. It may be advisable to include a battery in the grid circuit to make the average value of the grid voltage negative with respect to the filament, thus reducing the grid current, and hence the power dissipated by the grid. The type VT-2 tube normally operates with a grid voltage of -20 .

In place of a grid battery it is often more convenient to insert in the grid lead a resistance shunted by a condenser. Since grid currents flow through the resistance, during oscillation the grid voltage becomes negative: the amount of the negative voltage is the product of the resistance in ohms by the current in amperes. A third method of obtaining a negative voltage on the grid is to insert a resistance in the lead from the negative side of the plate battery to the filament and to connect the grid at the battery side of the resistance. The negative voltage is determined by the product of the battery current by the inserted resistance. This third method is much less efficient than either of the other two.

In tubes of the coated-filament type in which the filament emission is high the plates may become dangerously hot, even at the rated plate voltage and filament temperature. This at once leads to the inquiry as to why the efficiency of an electron tube generator is so low, leaving a relatively large fraction of the power input for dissipation in heat. The answer is indicated by the fact that the average value of the plate current while the tube is oscillating must always be greater than zero (Fig. 278). Since the plate current always flows in the same direction, its instantaneous peak value reached during an oscillation can never be much greater than its average value during the oscillation, even if the pulsations are not in the form

of sine waves. Assuming that the current supplied to the tube has pulsations in the form of sine waves, if the average value of the current to the tube, as indicated by a direct-current instrument is 0.05 ampere, then during an oscillation the maximum variation from the average value can not be greater than 0.05 ampere. This maximum variation corresponds to an effective value of the alternating part of the current of $\frac{0.05}{\sqrt{2}}$ or 0.035 ampere effective current. Hence the plate can never become negative with respect to the filament, and the greatest possible peak value for the plate voltage to assume at any instant during an oscillation is that of the plate battery, say 300 volts, which corresponds to an effective value of $\frac{300}{\sqrt{2}}$ volts. Thus, unless there be a marked distortion of the plate current wave, causing the effective value of current to be greater than the peak value divided by $\sqrt{2}$, the alternating-current power in the plate circuit, which must supply both the grid and the output circuit, can not exceed $\frac{300}{\sqrt{2}} \times \frac{0.05}{\sqrt{2}}$, or just half the power supplied by the plate battery or generator. The remaining 50 per cent of the input power is wasted in heat and may cause the plates to become incandescent. It is consequently desirable always to operate the tube with the circuit adjusted for maximum output and at the lowest value of filament heating current and plate voltage which will just supply this output.

No general rules can be given for adjusting a circuit to maximum output. If the resistance and capacity are fixed, as is frequently the case where an electron tube is used to excite an antenna, it is desirable to have means for varying independently the coupling between the plate circuit and the antenna circuit, the coupling between the antenna circuit and the grid circuit, and also the absolute value of inductance in the antenna circuit. In general, for a given inductance, the higher the resistance of the output circuit the lower the value of capacity at which maximum output is obtained.

The electron tube is far superior to the buzzer as a source of oscillations for measurement purposes. To secure constancy in both amplitude and frequency, it is desirable when several

tubes are used in the same circuit to have separate batteries for each tube. With care in this regard, constancy in both amplitude and frequency may be secured to one-tenth of 1 per cent.

The filaments of electron tubes used for generating may be supplied with direct current from a source which will maintain a constant voltage, as described above. For many purposes satisfactory results can, however, be obtained by supplying the filament with alternating current of the proper low voltage. A convenient source is a small transformer connected to a 110-volt lighting circuit. The transformer should have a tap from the mid-point of the low voltage secondary winding, to which the negative side of the plate battery may be connected. The voltage applied to the filament should be regulated by adjusting the primary circuit. A condenser of fairly large capacity should be connected from the mid-tap to each terminal of the secondary winding.

A fuse or other protective device should be inserted in the plate lead of the larger generating tubes, such as those supplying more than 10 watts. Since the currents involved are small, perhaps 0.3 ampere, the ordinary types of fuses will not answer. A simple homemade fuse can be made by fastening a small rectangular piece of tin foil to a piece of cardboard and connecting the tin foil into the circuit so that the current will pass along the longest dimension of the piece of tin foil. The width of a piece of tin foil of a given thickness required to construct a fuse which will open the circuit when a certain current is reached can be determined by starting with a wide piece and successively removing strips of tin foil until the circuit through the remaining strip is opened.

A by-pass condenser of fairly large capacity is usually connected across the terminals of the d.c. generator, so that the radio-frequency currents do not pass through the armature of the generator. (Figs. 279 and 280.) This reduces the impedance of the radio-frequency circuit and protects the generator against injury due to excessive currents which might be caused by high-frequency surges flowing through the generator windings. The condenser also serves to reduce the "commutator ripple," i. e., the slight drop in generator voltage occurring

when brushes do not touch any commutator segment. This commutator ripple may be found troublesome in communication. See also Appendix 9, p. 578.

Instead of the condenser, aluminum electrolytic cells may be connected across the line. One type of such an electrolytic cell can be constructed in a simple manner by placing a strip of aluminum and a strip of lead in a glass jar containing a saturated solution of borax. The voltage which an aluminum electrolytic cell can safely be called upon to handle depends upon the solution used; a cell containing the saturated solution of borax just mentioned should not be expected to withstand more than 100 volts.⁵

The aluminum electrolytic cell can also be used for rectifying alternating currents, although there are various practical inconveniences incidental to its use for this purpose.⁶

Tubes Suitable for Developing Considerable Power.—It has been explained that the two factors which determine the power put into a tube are the plate voltage and the filament emission and that the efficiency with which this power is converted into oscillating current depends for values of efficiency below 50 per cent only upon the adjustment of the external circuits. Thus the possible output of a tube can be increased either by increasing the surface area, and hence the emission of the filament, or by increasing the degree of vacuum, in order to allow a higher plate voltage to be used. The large "pliotrons" (see Fig. 266) are capable of developing as high as 500 watts output because they are so highly exhausted that several thousand volts may be applied to the plate and because they can carry a plate current as high as 0.4 ampere. Since at least half the power put into the tube can not be used in producing oscillations, means must be provided to dissipate this waste heat. In certain pliotrons an average plate current of 0.15 ampere flows when a plate battery of 4000 volts is used, 600

⁵ For further information regarding the use of the aluminum electrolytic cell as a protective device the reader may refer to: E. E. F. Creighton, *General Electric Review*, vol. 16, p. 248, April, 1913; C. P. Steinmetz, *General Electric Review*, vol. 21, p. 590, September, 1918; Williams and Cork, *Electrical World*, vol. 74, p. 937, Nov. 15, 1919; Rhoads, *Journal A. I. E. E.*, vol. 40, p. 318, April, 1921.

⁶ The construction of the aluminum electrolytic cell and its operation as a rectifier for use with tube generating sets is described by P. J. Furlong, *Q. S. T.*, vol. 4, p. 17, February, 1921.

watts being thus supplied to the tube. If the circuit is operated efficiently, 300 watts may be used in the output circuit and grid circuit, the remaining 300 watts, or nearly a half horsepower, going into heat at the plate. Thus the plates must be so constructed as to radiate heat rapidly, and provision must be made for cooling the tubes. By operating a number of such tubes in parallel a large amount of power can be converted.

The construction of various types of tube transmitters is described in a paper by T. Johnson, *Proceedings Institute Radio Engineers*, vol. 9, p. 381, October, 1921. A tube transmitter used at Clifden, Ireland, for transatlantic work, employing 12 large power tubes, and capable of putting over 200 amperes into the antenna, is described in a paper by H. J. Round, *Radio Review*, vol. 2, p. 459, September, 1921.

204. Alternating Current Plate Supply.—In the generating circuits previously shown the power is supplied by a battery or by a direct-current generator. In tube transmitting sets the power is often supplied by high-voltage, direct-current machines. Although such machines are extensively used, they are very expensive and are subject to failures of the commutator and of the armature windings. This is particularly true of machines having a commutator voltage in excess of about 500 volts. For some purposes it is possible to operate the transmitting tube by supplying power to the plate from an alternating-current source having the effective value of the a.c. voltage supplied to the plate approximately the same as the rated d.c. plate voltage and still obtain a power output and an efficiency as great as that obtained with a d.c. generator. The a.c. voltage supplied to the plate can usually be safely increased to an effective value considerably above the rated d.c. plate voltage of the tube, with a corresponding increase in the output of the tube. Experimental difficulties will be met, however, at the higher voltages, particularly the necessity for careful insulation of all parts of the circuit.

The difficulties met in the operation of high-voltage d.c. generators are thus avoided. Such a tube transmitter is a tone generator, which with crystal or with tube detector reception gives a musical note in the telephones corresponding in frequency to that of the alternating-current supply. With single-phase a.c. supply of frequency f , the radio-frequency

waves come in pulses of f times per second, and the effective decrement of the wave may be appreciable. The output of such a generating set is completely modulated—that is, the amplitude of the oscillations is periodically reduced to zero.

If it is possible to secure alternating current of an easily audible frequency, such as 800 cycles, this type of transmitter is an excellent substitute for the more elaborate electron tube tone transmitters whose plates are supplied with d.c. voltage and which have either chopper or buzzer modulation. The wave form for the output current of such a transmitter is shown in

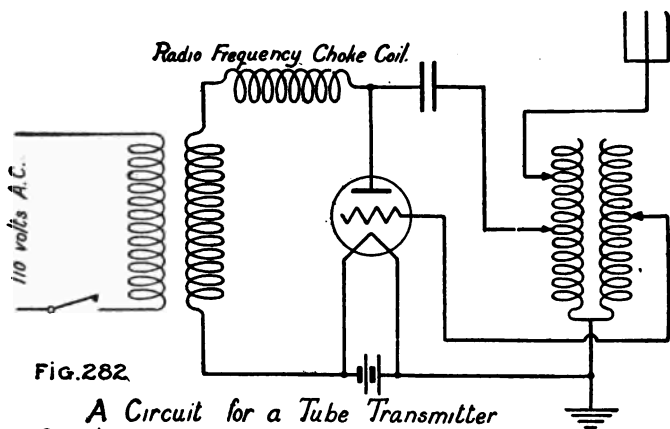

Fig. 282

*A Circuit for a Tube Transmitter
Supplied with Alternating Plate Voltage*

Fig. 283, except that with high radio frequencies there will be considerably more oscillations per train than could be conveniently drawn. The voltage of the plate supply is also shown on this diagram. It is evident that no oscillation can occur during the half cycle in which the plate supply is negative. A circuit which can be used with a.c. plate supply is shown in Fig. 282. An electron tube transmitter of completely modulated waves, using 500-cycle modulation, is described in Bureau of Standards Scientific Paper No. 381.

Heterodyne or other beat reception may also be advantageously used, as is usual with continuous waves. It is possible, though

not as desirable, to use for the plate supply voltage, alternating current of low commercial frequencies, such as 60 cycles. If it is necessary to use alternating current of as low a frequency as 60 cycles, more satisfactory results will be obtained with heterodyne reception. The heterodyning of course destroys the purity of the tone emitted by the transmitter, but gives much better reception than a crystal detector or simple tube detector. If a low frequency, such as 60 cycles, is used, the received signal can be improved by using a "chopper" at the transmitting station. (See Sec. 211.) It is preferable, if possible, to use for the power supply of the transmitter an alternating current of an easily audible frequency, such as 800 cycles.

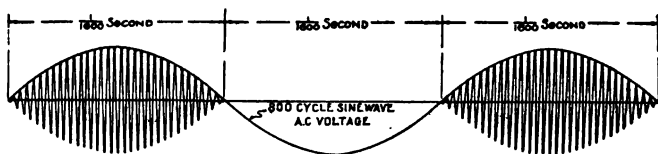

WAVE FORM OF OUTPUT CURRENT FROM TUBE TRANSMITTER HAVING
PLATE SUPPLIED WITH 800 CYCLE SINE WAVE ALTERNATING CURRENT

FIG. 283

It should be noted that this alternating-current modulation of plate supply gives only one train of oscillations per cycle, corresponding to the intervals when the plate is positive—that is, 60-cycle modulation of plate supply gives only the same tone as a fixed gap with a 30-cycle a.c. supply, since the latter gives two trains of oscillations per cycle.

By connecting the plates of two tubes to the secondary terminals of a single-phase transformer, one plate to each secondary terminal, both halves of the cycle of supply voltage from a single-phase a.c. line can be used to operate the tubes. If this is done, it is desirable to use heterodyne reception. It is also possible to effectively use two-phase or three-phase alternating current as plate supply in power generators; in this case the amplitude of the oscillations is much more nearly constant, and with three-phase supply does not drop to zero.

For further information regarding the use of both halves of the cycle and two-phase and three-phase plate supply, refer-

ence may be made to K. B. Warner, Q. S. T., volume 4, page 7, December, 1920, and volume 4, page 52, February, 1921; L. M. Clausing, Q. S. T., volume 4, page 6, February, 1921; W. C. White, U. S. Patent No. 1394056; British Patent 252 of 1914; British Patent 127008; French Patent 493222. Details regarding the use of three-phase a.c. plate supply are given by V. J. F. Bouchardon in United States Patent 1373710.

205. **Beat Reception.**—If a tuning fork vibrating 256 times per second is mounted near to a tuning fork vibrating 260 times per second, so that the two forks sound together, a listener a short distance away will hear a sound alternately swelling out and dying away four times per second. These tone variations are called "beats." The production of beats has been discussed in Section 122. Similarly, if two sources of undamped electrical oscillations of constant amplitude act simultaneously upon the same circuit, one of frequency 51,000 and the other of frequency 50,000 cycles per second, the amplitude of the resultant oscillation will successively rise to a maximum and fall to a minimum at the rate of 1000 times a second, the difference between 51,000 and 50,000. If rectified by a tube detector or crystal detector, the variations of the resultant oscillation will produce an audible note of frequency 1000 in a suitable telephone receiver. If one of the two oscillations is the received signal in the antenna and the other is generated by a circuit in the receiving station, we have "beat" or "heterodyne" reception. In the receiving telephone a musical note is heard whose pitch is readily varied by slight variation of the frequency of the local generating circuit. The application to radio communication of the principle of beats, which had long been familiar in sound and other fields of science, is due to Fessenden. If the amplitude of the locally generated oscillations is equal to the amplitude of the incoming oscillations, the condition of "equal heterodyne" is said to exist. In actual practice the amplitude of the locally generated oscillations is usually considerably greater than the amplitude of the received oscillations. In fact, it is usually found that the maximum signal in the telephone receivers is not obtained for "equal heterodyne."

The principle is shown in Fig. 284. Oscillations of frequency f_1 are superimposed on oscillations of frequency f_2 ; the amplitude of the oscillations of frequency f_2 is equal to three

times the amplitude of the oscillations of frequency f_1 . The resultant oscillations have a beat frequency of $f_1 - f_2$, that is, the maximum value of the resultant oscillations is attained

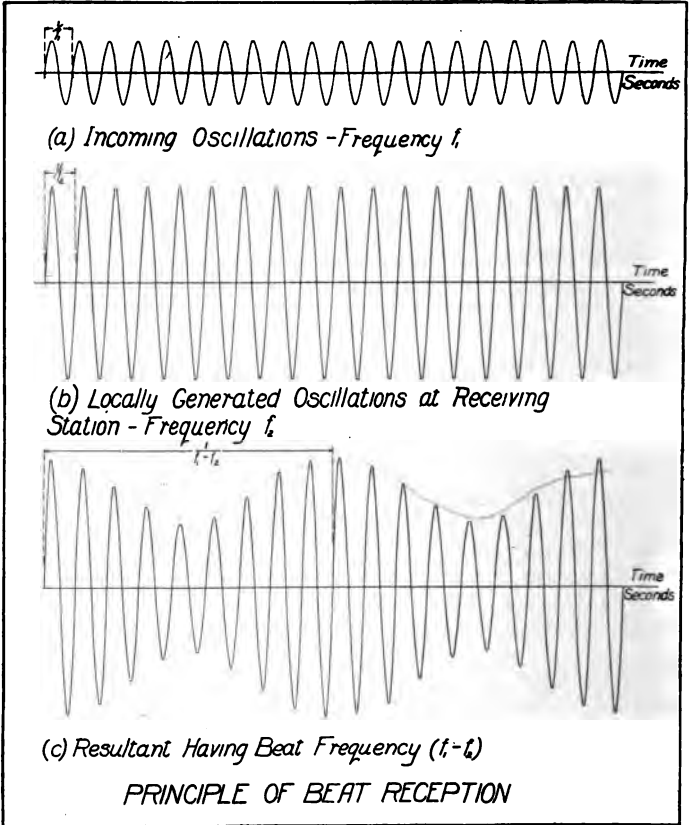

FIG. 284.

$f_1 - f_2$ times per second. The value of the resultant at any instant is obtained by adding together the values at that instant of the oscillations from the two sources. When these two

oscillations are in phase, the resultant oscillation has a peak. When the two oscillations are of opposite signs and equal magnitude, the value of the resultant is zero. In Fig. 284, during the fractional part of a second represented there are 15 oscillations of frequency f_1 , 12 oscillations of frequency f_2 , and the maximum value of the resultant is attained $15-12=3$ times. The amplitude of the resultant oscillations varies from four times to twice the amplitude of the oscillations of frequency f_1 . The maximum amplitude, 4, corresponds to the sum of the amplitudes of f_2 and f_1 ($3+1$), and the minimum amplitude, 2, corresponds to the difference of the amplitudes of f_2 and f_1 ($3-1$).

When the resultant wave form is received with any form of rectifying detector, the part of the resultant wave below the zero axis is almost entirely eliminated, as has been explained in the discussion of detector action above. The telephone receiver diaphragm is acted upon by impulses which vary at the beat frequency f_1-f_2 and emits the tone corresponding to this beat frequency.

If a regenerative circuit similar to that of Fig. 275 is used (L being coupled to the antenna), the same tube may be used as a detector and as a generator of local oscillations. This is called "autodyne" reception. The procedure is to tune the antenna circuit to the incoming signals and adjust the local oscillating circuit so that it is slightly out of tune with the incoming signals. Beats are thus produced of an audible frequency equal to the difference between the frequency of the incoming oscillations and the frequency of the local oscillations. Measurements have shown that this method is so sensitive that signals can be heard when the power received is equal to only $\frac{1.5}{10^{13}}$ watt—that is, 0.015 micromicrowatt. The autodyne method is thus much more sensitive than the crystal detector or simple detector tube. The use of a separate source of oscillations has the advantage over the autodyne method that looser coupling can be used with resultant sharper tuning, making it easier to tune out interfering stations, and that the beat note can be varied without changing the tuning adjustments of the receiving circuit. In Fig. 239-a, page 427, a circuit is shown which can be used for autodyne reception, and is particularly adapted to wave lengths of less than 400 meters.

Of the several methods of receiving continuous waves in radio telegraphy which are discussed in Section 181, the heterodyne method is in most general use, and has a number of advantages. As just mentioned, the heterodyne method will give readable signals when the power received is very small; in fact, good signals can be received by the heterodyne method when the use of a "chopper" or "tikker" at the receiving station would not give a signal which could be heard. This sensitivity greatly increases the range over which a given receiving station can receive. With the heterodyne method the note in the telephone receivers can be adjusted as desired to correspond to the frequency at which the telephone receiver diaphragm is most sensitive, or to suit the ear of the receiving operator, or to be easily read through interfering signals from other stations, so that interference from other stations is reduced to a minimum. A slight difference in the frequency of the interfering signal would give a note of entirely different pitch, or a note which would be entirely inaudible. For instance, if the local oscillation had a frequency of 50,000 ($\lambda=6000$ meters), the received oscillation a frequency of 51,000 ($\lambda=5880$ meters), and the oscillation from the interfering station a frequency of 52,000 ($\lambda=5770$ meters), the interfering note as heard in the telephone receiver would have a frequency of 2000, or be a whole octave higher in pitch than the note which it is desired to receive. If the wave of the interfering station had a frequency of 55,000 ($\lambda=5455$ meters), its beat tone would be so high as to be inaudible.

It should be noted that the heterodyne method requires very sharp tuning adjustments and that slight changes in the positions of leads or objects adjacent to unshielded condensers may cause sufficient change in capacity to cause considerable changes in the note in the telephone receiver. The method is best adapted to long waves. With comparatively short waves, under 1000 meters, the tuning adjustments required to get an audible beat frequency are so sharp that much difficulty may be experienced in adjusting so that any signal at all is heard, and if a slight readjustment is inadvertently made the signal will be lost again. These difficulties are not so noticeable when receiving long waves such as are commonly used by high-power stations transmitting undamped waves, which are often longer than 10,000 meters.

The heterodyne method is not well adapted to receiving damped waves or modulated continuous waves such as are used in radiotelephony, since the incoming waves do not have a single frequency but a number of frequencies, and a number of beat frequencies are obtained which give a "mushy" note which is not clear and is somewhat difficult to read. In radiotelephony it is sometimes found desirable to use at the receiving station local oscillations of the same frequency as the radio-frequency generated at the transmitting station; in this case a clear note will be obtained as long as the frequency of the local oscillation is maintained constant.

In heterodyne reception, if we assume that the amplitude of the local oscillations is constant, the amplitude through which the resultant oscillations vary is directly proportional to the amplitude of the incoming oscillations. This amplitude through which the resultant oscillations vary, at the audible beat frequency, determines the intensity of the signal in the telephone receivers. In connection with Fig. 284 we have discussed the amplitudes of the different oscillations, using the amplitude of oscillations of frequency f_1 as a unit. Using this unit, for the case shown in Fig. 284 the amplitude of the resultant oscillations varies from 2 to 4 through a range of 2. If we assume a case in which the amplitude of the incoming oscillations is decreased one-half, but the local oscillations have the same amplitude, and use the same unit, it is evident that the amplitude of the resultant oscillations will vary from 2.5 to 3.5 through a range of 1—that is, decreasing the amplitude of the incoming oscillations one-half has decreased by one-half the amplitude of the resultant oscillations. The signal in the telephone receiver is correspondingly decreased.

This relation of direct proportionality for beat reception is different from the relation for simple detector reception. For the latter the output of the detector tube is proportional to the *square* of the amplitude of the incoming oscillations. The relation of direct proportionality constitutes one of the chief advantages of beat reception and one of the chief advantages obtained by the use of continuous waves. These relations were pointed out by L. W. Austin, Journal Washington Academy of Sciences, volume 6, page 81, February 19, 1916. This advantage obviously does not obtain for a spark station or for a station

transmitting modulated continuous waves for which beat reception can not be used.

If at a given station an interfering signal of any kind is being received of intensity greater than the signal which it is desired to receive, much better results will be obtained in attempting to copy the weaker signal through the interference if beat reception is used than if simple detector reception is used. The interference may be due to another station or to "strays." (See Sec. 130, p. 289.) Assume that at the same receiving station there are two receiving sets, one for beat reception and one for simple detector reception, and that at a particular moment the strays are three times as strong as the voltage oscillations in the antenna of the signal which it is desired to receive. Then in the output of the receiving set using beat reception having the relation of direct proportionality the strays will be three times as strong as the signal. But in the receiving set using simple detector reception having the square law the strays will be nine times as strong as the signal. This is one of the principal reasons that a continuous wave station of a given power can often maintain communication over five times the distance reached by a spark station or modulated continuous-wave station of the same power.

For further information regarding beat reception the reader may refer to R. Stanley, *Wireless Telegraphy*, volume 2, chapter 8; to H. J. van der Bijl, *The Thermionic Vacuum Tube*; to J. H. Morecroft, *Principles of Radio Communication*; to Bureau of Standards Circular No. 74, page 215; and to a paper by M. Latour, *Radio Review*, volume 2, page 15, January, 1921.

Reduction of Frequency of Input of Radio-Frequency Amplifier by Beat Method.—It has been pointed out above that for short wave lengths, particularly for wave lengths of less than 300 meters, radio-frequency amplification is attended with much difficulty caused by capacity effects between different parts of the circuit. One way to avoid this difficulty is to reduce the high frequency of the incoming wave to a lower but not audible radio frequency by the beat method. Thus if the incoming wave has a wave length of 100 meters—that is, a frequency of 3,000,000 cycles—a local generating set may be coupled to the antenna circuit to supply a frequency of 3,100,000 cycles. The resultant current in the antenna circuit

will have a beat frequency of 100,000 cycles, which can be easily amplified with a radio-frequency amplifier. The output of the radio-frequency amplifier can then be treated as in the usual methods of reception; it can be detected and amplified at audio frequencies or can be made audible by a second heterodyne, as described earlier in this section. This method requires critical adjustments and considerable skill in manipulation. This method is very useful in the reception of feeble signals with coil antennas, as in direction-finding work. For further information the reader may refer to E. H. Armstrong, Q. S. T., volume 3, page 5, February, 1920; Proceedings Institute Radio Engineers, volume 9, page 3, February, 1921.

E. Radiotelephony.

206. **The Wave Forms Used in Radiotelephony.**—Speech is composed of complex vibrations, and a graphic record of the sound wave in air which transmits the simplest word shows a very complex wave form. The problem of any form of telephony is to accurately reproduce electrically at the distant receiving station the complex sound wave which is spoken into the transmitter. The principles of radiotelephony are the same as those of radiotelegraphy by undamped waves. In radiotelephony the sending key used in radiotelegraphy is replaced by apparatus which varies the transmitting antenna current in accordance with the sound waves produced by the voice. This device is usually the carbon microphone, which is described in Section 60b.

There are a number of ways in which a graphic record can be made of the wave form of the wave in air which corresponds to a given sound. A simple method is to record the sound on a phonograph record, then play the record slowly, and greatly magnify the motion of the needle by a lever arrangement which traces the wave. The wave forms corresponding to many different sounds have been studied.[†] A tuning fork may give nearly a pure sine wave, but the wave forms corresponding to most sounds are very complex.

[†] See D. C. Miller, *The Science of Musical Sounds*; E. W. Scripture, *The Study of Speech Curves*, Carnegie Institution Publication No. 44; *Scientific American Monthly*, vol. 3, p. 361, April, 1921.

In the transmission of radiotelegraphic signals by undamped waves, the pitch of the note in the telephone receivers is determined in part by the apparatus at the receiving station—as, for example, in heterodyne or autodyne reception. For transmission of sounds of definite pitch, or for transmission of speech, the nature of the received signal must depend upon the nature of the current in the transmitting aerial. In spark transmission the note depends upon the number of wave trains per second leaving the aerial, this being determined by the speed of the rotary gap or the frequency used in charging the primary condenser. Spark, tone, and radiotelephone transmitters differ from transmitters of undamped waves in that the strength of the radio-frequency antenna current is varying at an audio frequency. Ordinarily, the radiation from a spark transmitter is treated as being composed of successive trains of waves of radio frequencies. An alternative method is to describe it as a single wave whose amplitude is varying at audio frequencies. In Fig. 148 the intensity of the emitted wave is a maximum at point *D* of the curve and is zero during the interval between what are usually called the wave trains.

An alternating current is said to be *modulated* when the amplitude of its oscillations is varied periodically. The frequency at which the variations occur is necessarily less than the frequency of the alternating current which is being modulated. The nature of the variations may assume almost any form. Thus we may have dot-and-dash modulation, "chopper" modulation, buzzer modulation, sine-wave modulation (as at 800 cycles), and speech modulation. Speech modulation of radio-frequency currents radiated through space constitutes radiotelephony. Chopper, buzzer, and sine-wave modulation are often referred to under the general name of "tone modulation."

A modulated wave is symmetrical with respect to the zero axis; that is, the part of the modulated wave below the zero axis is a reflection of the part of the wave above the zero axis.

A radio-frequency wave of frequency f_r modulated by a sine wave of audio frequency f_a can be considered to be the sum of *three* radio-frequency waves having frequencies f_r , $(f_r - f_a)$, and $(f_r + f_a)$. The principal radio frequency f_r is called the "carrier" frequency, since it provides the means for carrying or

transmitting the audio-frequency wave, but it does not in any way determine the nature of the sound heard at the receiving station when simple detector reception is used. The audio frequency f_a is called the "modulating" frequency. The waves of frequency $(f_r - f_a)$ and $(f_r + f_a)$ are called the "side waves," and their frequencies are called the "side frequencies." Side waves always occur when the amplitude of the radio-frequency current is changed in any way. This method of considering a modulated wave to be the sum of a carrier wave and side waves is particularly useful in determining how a modulated wave will affect receiving apparatus.

When the usual dot-and-dash code signals are transmitted by undamped radio-frequency waves which have not been modulated at the transmitting station by a chopper, buzzer, 800-cycle alternating current, or similar method, it is necessary to use at the receiving station a chopper, heterodyne, or similar method, as described in Section 181. The dot-and-dash interruption of the transmitted wave constitutes, however, a variation of the transmitted wave, which is a form of modulation, and causes "side waves" having wave lengths irregularly distributed over a band. When dot-and-dash signals are transmitted at high speeds by automatic devices the band of wave lengths between the side frequencies is broader, and greater interference is caused. When automatic devices are used for both transmitting and receiving, the transmitting station does not usually transmit the signals of the International Code, but a series of impulses arranged only with regard to the most convenient operation of the apparatus.

When a radio-frequency wave is modulated by an audio-frequency wave the amplitude of the resultant wave at each instant is determined by the *product* of the instantaneous value of the amplitude of an audio-frequency wave into the instantaneous value of the amplitude of the radio-frequency wave at that instant. Thus modulating action should be carefully distinguished from heterodyne action as described in Section 205, since in heterodyne action the instantaneous value of the resultant is determined by the *sum* of the instantaneous values of the two component radio-frequency waves.

In modulating action the audio-frequency wave whose amplitude is multiplied by the amplitude of the radio-frequency wave

is ordinarily the sum of an audio-frequency wave (alternating current) and an unvarying component (direct current). The amplitude of the radio frequency is varied periodically above and below a certain value which is not zero.

For rough purposes of illustration of the process of modulation, the unmodulated radio-frequency wave can be thought of as a plastic substance which is molded in a form shaped like the form of the audio-frequency modulating wave. An illustration of a similar process is found in the impression of the wave form of a voice on the plastic wax of a master phonograph record, from which many records are made which will faithfully reproduce the voice. In radiotelephony the wave form of the voice, impressed on the radio-frequency carrier wave, is reproduced at many receiving stations.

The strength of the received signal depends not only on the average radio-frequency amplitude but also on the degree to which it is changed or modulated. An alternating current is said to be *completely modulated* when the amplitude of its oscillations is periodically reduced to zero. Complete modulation may occur in several different ways. The radio-frequency oscillations may be just reduced to zero at one or more points during each audio-frequency cycle so that the modulating audio-frequency boundary just touches the zero axis. There may be no radio-frequency oscillations at all during a part of an audio-frequency cycle, as shown for example in Fig. 283. The radio-frequency oscillations may be just reduced to zero at one or more points during each audio-frequency cycle in such a way that the upper and lower boundaries of the modulated wave cross the zero axis at these points as shown in Fig. 287 instead of simply touching the zero axis; the modulation of Fig. 287 occurs only when special circuits are used.

The more usual form of wave for radiotelephony is that shown in Fig. 286, in which the amplitude of the audio-frequency wave is not sufficient to cause complete modulation. It is, however, usually desirable that so far as possible adjustments should be made so that for speech of moderate intensity the amplitude of the radio-frequency oscillations should be instantaneously reduced just to zero in such a way that the boundaries of the modulated wave just touch the zero axis at a point but do not cross the zero axis. This would be the case in Fig. 286 if the

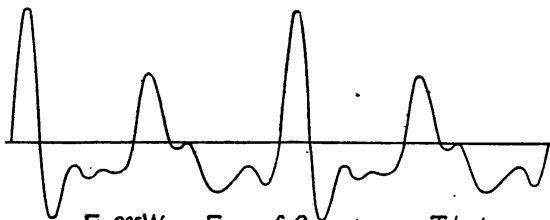

Fig.285 Wave Form of Current on a Telephone Line Transmitting the Sound of "a" as in "father"

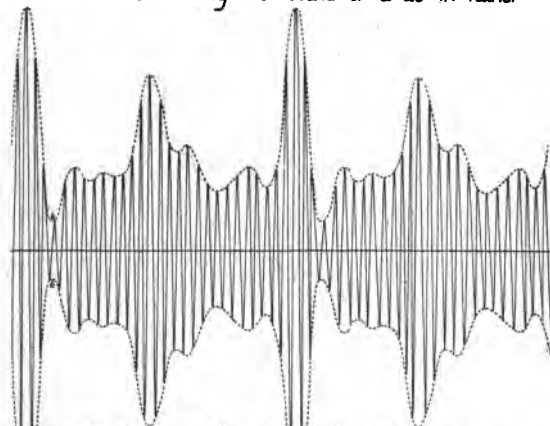

Fig.286. Antenna Current in Radiotelephony Transmitting the Sound of "a" as in "father" Modulated Radio-frequency Wave which can be received with Simple Detector.

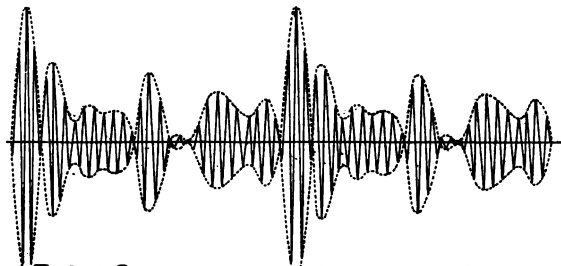

Fig.287 Antenna Current in Radiotelephony Transmitting the Sound of "a" as in "father." Radio-frequency Wave so Modulated that Beat Reception is Required.

upper and lower boundaries of the modulated wave were pushed toward the zero axis so that the points b , b' just touch the zero axis. In the circuits commonly used in radiotelephony, if the amplitude of the modulating audio frequency becomes too great the radio-frequency oscillations entirely cease during a considerable portion of the cycle, and a marked distortion of speech occurs; this is called "overmodulation."

The effect of overmodulation in an electron tube radiotelephone transmitting set is similar to the effect during part of the cycle in an electron tube generating set having plate supply of sine wave alternating current of perhaps 800 cycles. The wave form for such a generating set is shown in Fig. 283, page 500. During the intervals when the plate voltage is negative, the radio-frequency oscillations cease. The wave form for a complete cycle of the 800-cycle sine wave corresponds to the modulating audio-frequency wave form in radiotelephony which causes overmodulation.

If the sound of the vowel "a" as in "father" is spoken into the transmitter of an ordinary wire telephone system, the wave form of the current on the line wire will be substantially that shown in Fig. 285. If the same vowel is spoken into the transmitter of a radiotelephone system using the ordinary circuits, the wave form of the antenna current will be as shown in Fig. 286. If the principal frequency of the wave form of Fig. 285 is 800 cycles, then in the telephone receiver the principal frequency for the received signal corresponding to the wave shown in Fig. 286 will also be 800 cycles. The strength of the received signal depends not only on the average radio-frequency amplitude but also on the degree to which the amplitude of the radio-frequency oscillations is changed or modulated.

Since in ordinary wire telephony audio-frequency currents from about 100 to 3000 cycles are used, the number of radio-frequency cycles per audio-frequency cycle may range from 333 to 10,000 for short waves of 300 meters, to 6.6 to 200 for long waves of 15,000 meters. The dotted boundary of Fig. 286 determines the nature of the received signal in the telephone receiver and is called the "envelope" of the radio frequency. In determining the nature of the received signal, this envelope should be drawn on only one side of the zero current line.

In radiotelephone reception it is not possible to use ordinary beat methods and to supply at the receiving station a locally generated radio frequency different from the carrier frequency. If an attempt is made to do this, the beat notes between the locally generated frequency and the carrier frequency and the side frequencies will all be present in the telephone receiver in addition to the modulating audio frequency which is present in the receiving circuit because of detector action on the incoming wave. This will result in great confusion. As stated below, however, it is possible to supply at the receiving station locally generated oscillations of exactly the same frequency as the carrier frequency, provided that all adjustments are kept fixed so that the frequency of the local oscillation is maintained constant. If the carrier frequency supplied is of the proper magnitude and phase relation, only the audio frequency impressed at the transmitting station will be heard at the receiving station, and satisfactory transmission will be obtained. At short-wave lengths it is particularly difficult to maintain the local oscillation sufficiently constant to avoid distortion.

If some special forms of circuit are used, the antenna current will have a wave form as shown in Fig. 287. In tube radiotelephone sets this involves the use of one or more additional tubes. With high-frequency alternators, one way of obtaining the wave form of Fig. 287 is to pass the modulating current through the field windings. (See Alexanderson, U. S. Patent 1386830.) The boundaries used in constructing Fig. 287 are the same as the boundaries of Fig. 286, but they cross the zero current line. If the principal frequency of the wave form of Fig. 285 is 800 cycles, then the signal which would be received by a simple detector from the wave form of Fig. 287 would have a fundamental frequency of 1600 cycles, this being determined by the envelope on one side only. This kind of a completely modulated wave can be used for transmission of radiotelegraph signals with simple detector reception, but if used for transmission of speech with simple detector reception distortion will result. The wave form of Fig. 287 can, however, be altered at the receiving station by addition of a single radio-frequency current of the proper magnitude and phase relation so that the voltage impressed on the detector will be of the same nature as that of the wave of

Fig. 286, and the signal heard in the telephone receiver will correspond to the wave of Fig. 285. The wave form of Fig. 287 can thus be used for radiotelephony. The radio-frequency supplied at the receiving station has the same frequency as the carrier-frequency wave, which is modulated at the transmitting station; this kind of reception is sometimes called "homodyne" reception or "zero beat" reception. Homodyne methods are also sometimes referred to as "suppression of the carrier wave." The homodyne method can be considered as a special case of beat reception. This method has considerable advantages as to electrical efficiency. During the intervals when nothing is being spoken into the microphone no wave is radiated. The frequency of the wave supplied at the receiving station must be very accurately adjusted, however, to avoid distortion. For short waves this adjustment is so critical that this method has been used very little up to the present. The wave form of Fig. 287, with homodyne reception, is used to a considerable extent for radiotelephony with long waves. If carrier-frequency current of the proper magnitude and phase is added at the receiving station to the wave form of Fig. 286, the signal intensity will be increased.

For a further discussion of homodyne methods, see H. J. van der Bijl, "The Thermionic Vacuum Tube," p. 358; Colpitts and Blackwell, *Jnl. A. I. E. E.*, **40**, 307, 314; April, 1921; Alexander-son, U. S. Patent No. 1386830.

The antenna power during speech may pulsate from zero to twice or three times the average value. In modern radiotelephone sets this power is controlled electrically by the use of microphone, battery, and transformer, which in themselves would be capable of putting about 0.10 watt of power into a wire telephone line from the secondary of the transformer. The amplifying property of the electron tube has to a great extent made radiotelephony practicable, because it is a means by which large antenna power may readily be controlled from the small electrical power output of a microphone circuit.

Interference from Modulated Continuous Waves.—An unmodulated continuous wave as produced, for example, by an electron-tube generating set has no decrement, and for this reason very sharp tuning adjustments are used at the receiv-

ing station. A single wave length is radiated by the antenna, which is, of course, always desirable.

However, as stated above, when a continuous wave is modulated at an audio frequency, the antenna radiates not a single wave length, but a modulated wave which can be considered to be the sum of waves of different radio frequencies. In radiotelephony there are at each instant a number of modulating frequencies besides the principal modulating frequency, and the amplitude and frequencies of the modulating wave are changing from instant to instant. As a result a band of a considerable number of different wave lengths is radiated. These are the "side waves" mentioned above. A modulated continuous wave will act upon an ordinary receiving station in a manner which is, so far as tuning properties are concerned, much the same as a damped wave of appreciable decrement. The extent of this effect depends, among other things, upon the wave length used and upon the principal audio frequency of modulation. At comparatively short distances, interference over a wide range of tuning adjustments may be experienced from stations transmitting modulated continuous waves. More serious interference is caused when long wave lengths are used. This interference is a limitation on the use of long waves for radiotelephony.

The width of the band of side waves radiated can to a considerable extent be controlled by the use of filters, which have been mentioned on page 246. The use of filters at a receiving station will reduce interference from transmitting stations which it is not desired to receive. Filters are further discussed on page 534 in connection with line radio communication.

Linkage of radiotelephony with line telephony.—One of the most important applications of radiotelephony is to make possible communication between points between which the construction of a metallic circuit is not practicable or not convenient, as across desert country or across large bodies of water. In order that communication by radio telephone may be available to the general public, however, and not simply to persons who come personally to radio stations, it is obviously necessary that it shall be possible to connect or "link" the regular wire telephone system to the radiotelephone system. If radiotelephony is to be commercially possible, it is necessary that such "linked" systems can be successfully operated, and also

that conversations can be carried on in either direction without manipulating any switches, as is possible with the ordinary telephone. The apparatus used for linkage is very similar to the "repeaters" and auxiliary apparatus used on long-distance telephone lines on land.

A radiotelephone system is in successful operation between Long Beach, Calif., and Santa Catalina Island, an island about 30 miles off the California coast. This radiotelephone system is connected to wire telephone systems at each end. Conversations have been carried on between Santa Catalina Island and a steamship in the Atlantic Ocean a considerable distance east of New York, using radio from Santa Catalina to Long Beach, wire lines from Long Beach to Deal Beach, N. J., and radio from Deal Beach to the ship. The radio station at New Brunswick, N. J., which is equipped with a 200-kw. high-frequency alternator, has also been linked with land telephone lines, and conversations carried on between ships in the Atlantic and cities situated some distance from New Brunswick.

For further information regarding linkage, the reader may refer to a paper by L. M. Clement, F. M. Ryan, and D. K. Martin, "The Avalon-Los Angeles Radio Toll Circuit," Proceedings Institute Radio Engineers, vol. 9, pages 469-505; Dec., 1921.

207. Methods of Modulation.—In radiotelephony, the production of speech-modulated waves of radio frequency involves, first, a generator of undamped waves, and, secondly, a means of causing variations in the current output of the generator which will accurately follow the vibrations of the voice. Any generator may be used which will produce a pure, undamped wave, including the high-frequency alternator and the electron tube generator. The arc converter has also been used for radiotelephony, but not with entirely satisfactory results. The simplest method applicable to any such generating device is to vary the radio-frequency antenna current by inserting a speech-controlled variable resistance in the antenna circuit at the transmitting station. This resistance in simple cases is a microphone. (See Sec. 60b, page 146.) In early experiments efforts were directed toward making microphones that would be of a resistance so low as to be comparable to that of the antenna and capable of dissipating power comparable to the antenna power. In such modulation the radio-frequency power output is shared between the antenna resistance and the microphone, and the

method just described constitutes variable absorption at audio frequencies of the radio-frequency output. A better method of modulation is to insert the microphone or other variable resistance in the d.c. power supply of the generating system in such a way that the d.c. input, and hence the radio-frequency output of the generating system will be varied by varying the power input. The continuous wave arc transmitter of Fig. 229 may be made a radiotelephone transmitter by replacing the hand-controlled resistance B by a suitable speech-controlled resistance or microphone. In this case all of the radio output of the generator is available for transmission purposes, and therefore, for a given transmission range, smaller and less powerful generating equipment may be used than in modulation by the variable audio-frequency absorption of the radio-frequency output power.

Constant-speed high-frequency alternators may be efficiently modulated by varying the antenna inductance. The antenna is tuned and detuned in consequence at the audio frequency without change of the radio frequency, since the latter is determined solely by the generator speed. The inductance variation is accomplished by use of the principle that the effective inductance of a coil wound on an iron core depends upon the average magnetizing force applied to the magnetic circuit. The device used has been called the "magnetic amplifier"⁸ because it furnishes a means for controlling a large amount of radio-frequency power by means of a small amount of audio-frequency (speech-frequency) power. The device is, however, not a true amplifier since there is no relaying action by which input power of audio frequency produces a larger output power of audio frequency. For small or large initial magnetizing forces the inductance is small, but for intermediate forces it is large. A separate winding is used on the core, the current through this winding is varied at the speech frequency, and the antenna circuit is tuned and detuned in consequence. The magnetic amplifier as usually connected to large alternators operates as a variable impedance connected across the alternator. The adjustments

⁸ See Sec. 173. A. N. Goldsmith, *Radio Telephony*; E. F. W. Alexanderson, *Proc. Inst. Radio Engineers*, vol. 4, p. 101, April, 1916; *General Electric Review*, vol. 23, p. 794, October, 1920; E. E. Bucher, *General Electric Review*, vol. 23, p. 813, October, 1920; Alexanderson, U. S. Patent 1386830.

are so made that the changes in the antenna current are approximately directly proportional to the changes in the controlling current. Electron tube amplifiers are generally used with this device because the audio-frequency power required for the control of any but the smallest sizes of magnetic modulators is much greater than the power output of a microphone system. The variable-antenna-reactance method is not directly applicable to tube and arc circuits, because the frequency is determined almost entirely by the constants of the oscillating circuit, and a variation of the reactance would change the wave length without necessarily changing the current.

An iron-cored device called the "magnetic modulator" has recently become available in small sizes suitable for controlling currents of five amperes or less and costing from \$10 to \$20. The manufacturer states that when properly connected these small magnetic modulators are suitable for use in low-power tube radiotelephone transmitting sets; that they may be inserted directly in the ground lead; and that they provide a linear non-distorting control of the antenna current and will operate with very small values of control current. With such a modulating device a radiotelephone transmitting set can be constructed with a single tube, which is used as a generator. The necessity for an additional tube used as a modulator is thus eliminated. This magnetic modulator has a winding through which the controlling current of speech frequency flows, and its operation is in some respects like that of the "magnetic amplifier" used with high-frequency alternators at large stations. It behaves, however, more as a variable resistance than as a variable reactance, so that the modulation due to the variation of the impedance by variation of the resistance is produced by a method involving variable absorption at the audio frequency of the radio-frequency input power. The magnetic modulator is a rugged device. One advantage of the magnetic modulator is that it can be used for years, while a tube used as a modulator is subject to burn-outs of the filament and has a considerably shorter life.

Telephony by direct variation of the wave length has been accomplished, but the speech reception depends upon the automatic tuning and detuning of the receiving station, which requires especially good design and adjustment of the receiving apparatus. The wave-length variation may be obtained by connecting in the antenna circuit or across a part of it a device such

as a condenser transmitter, which is a voice-controlled variable condenser having a diaphragm as in the ordinary microphone transmitter.

208. Modulation of Electron Tube Generators.—With the exception of modulation by inserting a microphone in the antenna circuit as just described, the simplest method of modulating an electron tube generator is to insert the secondary of the transformer in a microphone circuit in the grid lead, as shown in Fig. 289. If necessary, the secondary can be shunted by a radio-frequency by-pass condenser. The secondary voltage is varied by the changes of current in the primary, caused by the variation at speech frequency of the resistance of the microphone. This method, while simple, is not effective, because the change in the average grid voltage during a radio-frequency cycle does not change the output appreciably when the grid voltage is adjusted for maximum output; its greatest effect is on the input power. Better modulation will be obtained if the tube is operated at reduced output. In either case this method of grid modulation is not efficient. If the grid voltage is sufficiently reduced, the tube may suddenly cease to oscillate and the radio-frequency current will drop to zero; if this occurs during speech, distortion will result.

With two tubes available, modulation can be readily effected in a simple manner by the "absorption method." In this method the radio-frequency output of any simple electron tube generator is absorbed to an extent which varies from instant to instant. The extent of the absorption varies at audio frequencies in accordance with the wave form of the speech impressed upon the microphone. The tube which is generating radio-frequency oscillations is shunted by a second tube which acts as an absorber. In Fig. 290 the plate circuit of tube *A* is in parallel with the plate circuit of the generator tube *G*, but the voltage applied to the grid of tube *A* is varied at speech frequencies by the output of the circuit containing microphone, battery, and transformer. Since the same radio-frequency voltage exists across the plate circuits of the absorber tube and the generator tube, and since there is no corresponding radio-frequency voltage on the grid of the absorber tube, the absorber tube consumes radio-frequency power from the output of the generator tube, thus lessening the power available for

radiation from the antenna. The amount of power absorbed by this tube is varied at speech frequencies by varying the grid voltage by use of the microphone, which changes the resistance

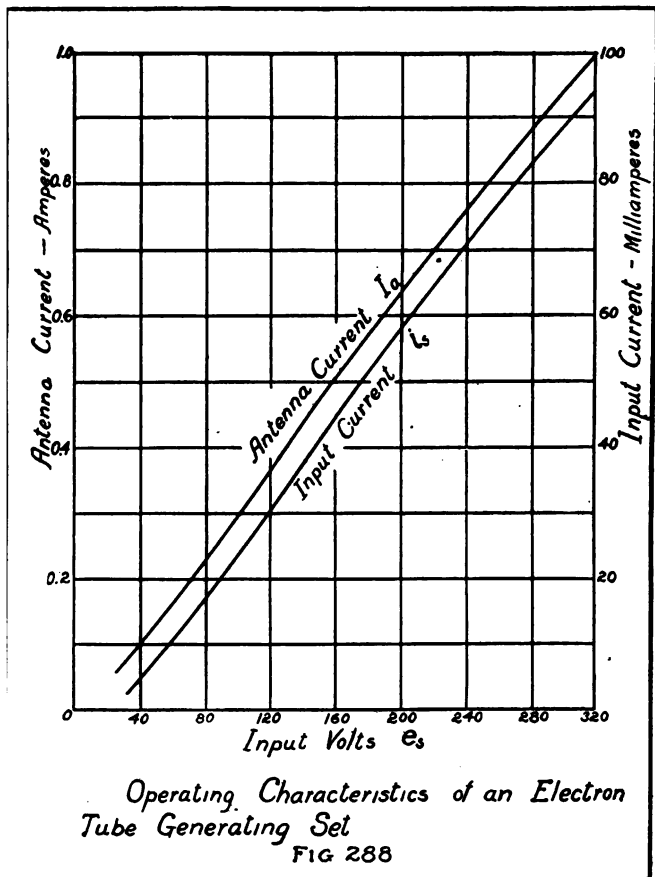

of the absorber tube. In this circuit the inductance L_0 must be a choke-coil of high impedance to currents of radio frequency, but need not necessarily offer a high impedance to currents of audio

frequency. During the radio-frequency cycle the radio-frequency plate current of the absorber tube is high when the radio-frequency plate voltage is high, which is just the reverse of conditions when the tube is used as a generator or amplifier. This method, while involving simple construction, is not used in practice, because it is inefficient. It is equivalent to the use of a low-resistance microphone of large power-consuming capacity in the antenna circuit. A mechanical analog of this method would be the variation of the speed of a steam engine by varying the pressure on a brake applied to the flywheel. It corresponds to the reduction of an alternating-current voltage by inserting a series resistance in the line instead of using a transformer. With similar tubes, if the generator tube generates 5 watts of power, $2\frac{1}{2}$ watts are absorbed by the absorber tube when the grid voltage of the modulator tube is constant, and this $2\frac{1}{2}$ watts is varied between zero and 5 watts as extreme limits. Using other circuits with the same two tubes, it is possible to have 5 watts of radio-frequency power available, which can be modulated between extreme limits of zero and 10 watts.

The most common method of tube modulation is by variation of the input plate power—that is, the average plate voltage and plate current of the tube or tubes generating radio-frequency oscillations are caused to vary at the lower or modulating frequency. This corresponds to controlling by the throttle the power used in a steam engine. This method also corresponds to the use of a microphone device in the plate power lead. It is very similar to the method of modulation applicable to arcs mentioned above in Section 207, page 517.

Advantages of the method of modulation by variation of the input power are (1) the variations in antenna current are more nearly directly proportional to the variations in the microphone current than in other systems; (2) the generator tube can be worked at its full output, and the average output during modulation will not be less than the unmodulated output; (3) the efficiency remains fairly constant during modulation; (4) the adjustment of the generator circuit for best operation during speech is the same as the adjustment for best operation when there is no speech signal.

While variation of a series resistance in the plate battery lead to a radio-generating circuit is a possible method, it is not used in practice, largely because it would be necessary that the generator voltage for efficient operation should be about double the voltage rating of the generating system in order to compensate for the drop across the modulating device. In practically all tube radiotelephone transmitters now used the modulation is effected by a method in which the voltage of the generator or high-voltage battery is the same as if the generating system were used for transmission of undamped waves. The general scheme is shown in Fig. 291. The equipment inside the dotted lines represents a generating system for which power would be ordinarily supplied to the plate by connecting a high-voltage battery or d.c. generator across the terminals marked $b+$ and $b-$. In any tube generator system there are included any devices which may be necessary so that only direct current will flow in the plate supply branch of the circuit. In Fig. 291 this device is the radio-frequency by-pass condenser C , and the generating circuit is precisely the same as that shown in Fig. 279. A modulator tube is placed across the terminals (Fig. 291), and the tube and generating system supplied in parallel from a common battery or generator B through an iron-core choke coil L . The grid voltage of the modulator tube is varied by connecting the secondary of a speech transformer between the plate and the filament. The action may be explained by reference to characteristics of the generating system. These are taken by leaving all other adjustments at a fixed setting, varying the voltage e_s across the terminals marked b , and reading this voltage e_s , the current to the terminals and the antenna current. It will be found that under proper conditions the antenna current I_a and the current to the generator set will be roughly proportional to the supply voltage e_s across the generating system. Such characteristics are shown in Fig. 288. To modulate the output it is necessary to vary the supply voltage e_s and the supply current i_s . If the quotient obtained by dividing the supply voltage by the supply current is R_s , then the problem is the same as the production of pulsations of audio frequency in an ohmic resistance R_s , as shown in Fig. 292.

A tube may be considered to be a variable resistance when acting as a modulator, as well as when acting as an amplifier

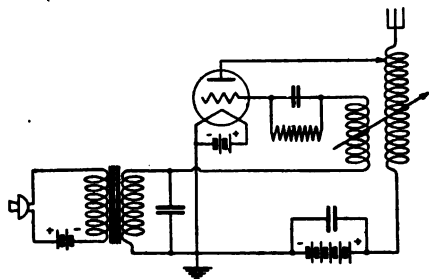

Fig. 289. Modulation of Output of a Tube Generator by Microphone Connected in Grid Circuit

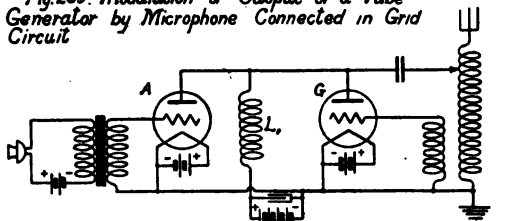

Fig. 290. Circuit for Radiotelephone Transmitter. Modulation by Absorption of Power Output of Generator Tube.

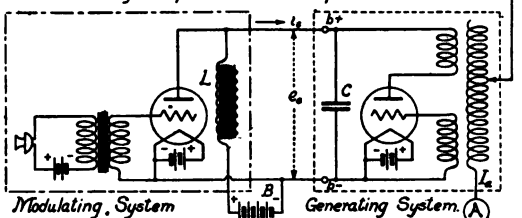

Fig. 291 Circuit for Radiotelephone Transmitter, Modulation by Variation of Power Input of Generator Tube.

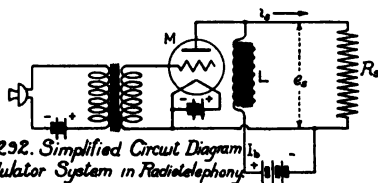

Fig. 292. Simplified Circuit Diagram of Modulator System in Radiotelephony.

or generator. The resistance of the modulator tube is high when the grid voltage is low, and the resistance is low when the grid voltage is high. This variation is made electrically at speech frequencies by the use of the microphone and a microphone transformer, the modulator tube and the generating system then are equivalent to two resistances in parallel, one of which is variable. (See Fig. 292.) Since the resistance is changed at speech frequency, there can be no appreciable change in the current I_b from the high-voltage battery, because variations in the current are smoothed out by the choke coil L . Accordingly, when the resistance of the modulator tube M is low, it takes more than the average current, and the load R takes less current. At the same time the plate voltage and the load voltage e_s are high. Similarly, when the resistance of the tube is high, the current to the tube is low, and the load voltage and the load current are high. Since the plate voltage is low when the plate current is high, the modulator tube is seen to be operating as an amplifier. The choke coil takes up the difference between the pulsating plate voltage and the steady voltage of the plate battery. The choke coil should be so designed that the current variation through it due to this difference in voltage is small. A safe rule would be to make the impedance of the choke coil at 500 cycles at least equal to the effective load resistance R_s . For the characteristics shown, this would call for an inductance of about one henry. Since there is direct current flowing through the choke coil, care must be taken that the iron is not working at too high flux densities.

To summarize: The variations at speech frequency in grid voltage cause variations at speech frequency in the tube resistance. Since the sum of the tube current plus the load current remains constant, the load voltage and the load current pulsate at the speech frequency. This load voltage and load current from the modulator tube constitute the power supply to a generating system, which has the characteristic that the antenna current is approximately directly proportional to the supply voltage. Accordingly the radio-frequency output is modulated at speech frequency, and the variation in the radio wave emitted causes an audio-frequency tone in the receiving equipment corresponding to the tone impressed on the microphone of the transmitting circuit.

For further information the reader may consult E. S. Purington, *The Operation of the Modulator Tube in Radio Telephone Sets*, Bureau of Standards Scientific Paper No. 423; and R. A. Heising, *Modulation in Radio Telephony*, Proceedings Institute Radio Engineers, volume 9, pages 305-352, August, 1921; Sci. Abs. B No. 1090, October, 1921.

200. Operation of Tube Radio Telephone Transmitting Sets.—Any tube circuit which may be used for the production of continuous waves may also be used as the circuit for generating radio-frequency current for a radiotelephone transmitter. Such generating circuits are shown in Figs. 279, 280, and 281, page 493. In the production of continuous waves by the use of any of these circuits, d.c. power is supplied by the source of the plate voltage E_B , which may be a battery or d.c. generator. To produce modulated radio-frequency current by the plate modulation method it is necessary to supply not only d.c. power to the plate of the generating tube but also a.c. power of the modulating frequency. To adapt to radiotelephony any of the circuits of Figs. 279, 280, 281, it is only necessary to connect the plate and filament terminals of the generator tube to the plate and filament terminals, respectively, of another tube used as a modulator. Radio-frequency choke coils should be inserted as necessary. In this case the radio-frequency generating system receives d.c. power from the same source as the modulator tube, and in addition receives the audio-frequency or speech-frequency a.c. power from the output of the modulator tube.

Although any type of generating circuit may be used for radiotelephony, the adjustments of certain parts of the generating circuit are in general different from what they would be for generating unmodulated continuous waves. Thus in Fig. 279 and Fig. 280 a condenser C_o operates as a by-pass condenser for radio-frequency currents, so that they are not required to flow through the source of d.c. power. In adapting such a circuit to radiotelephony, it is desirable to retain the by-pass condenser, in order to prevent radio-frequency currents from passing back through the modulator tube, which would cause loss of power at radio frequency, and would interfere with the proper operation of the modulator tube. The by-pass condenser should not be of so great capacity, however, that the modulator tube will furnish to the condenser a charging current of audio frequency

which will be of appreciable magnitude in comparison with the audio-frequency current which the modulator tube furnishes to the generating tube. The capacity of the by-pass condenser must be suitably chosen, then, so as to prevent radio-frequency current flowing back from the generating circuit into the modulator tube without at the same time preventing audio-frequency current from being efficiently delivered from the modulator tube to the generating circuit. In a similar manner, in Fig. 281 the choke coil L_0 performs in part the function of preventing radio-frequency currents flowing back into the plate battery. When this circuit is adapted to radiotelephony, however, the choke coil should not be of so high inductance as to prevent audio-frequency currents being efficiently delivered by the modulator tube to the generating circuit. While the necessity of making a suitable choice of choke or condenser is one of the things which limits the wave length which may be used, a satisfactory average may be readily reached in radio-telephony at short wave lengths. Another adjustment of the generating system in radiotelephony is also different, in that the system generally operates at lower average current for a given plate voltage than when it is used solely as a generator. This is to permit the plate current to increase when the supply voltage increases. The average current to the modulator tube or tubes is usually slightly greater than that to the generating system. The amount of the power output of the microphone which is available is often of importance in determining how the grid voltage of the modulator tube should be adjusted to give best modulation. With high-power tubes, the microphone power is usually amplified before the audio frequency is impressed on the grids of the modulator tubes.

In radiotelephone sets the generating system is provided with plate coupling, grid coupling, and wave length controls, so that it can be adjusted to suit the constants of the antenna. No controls, however, are used for the modulating equipment. Maximum antenna current is not necessarily the condition for maximum speech signal. Some sets are provided with a low-power lamp as a modulation indicator in the lead to the plate of the oscillator tube or in the lead to the generating system; the light is brighter during modulation than where there is no speech. This is because the heating effect of a pulsating current is

greater than the heating effect of the direct-current portion of the pulsating current would be by itself. Most sets are also provided with a coupling between the transmitter equipment and the receiver, so that the operator by hearing his own speech may know whether the quality is good. As a general rule the antenna current will not vary appreciably during modulation if the speech quality is good.

Special types of radiotelephone sets have been constructed for duplex or two-way conversations, so that communication can

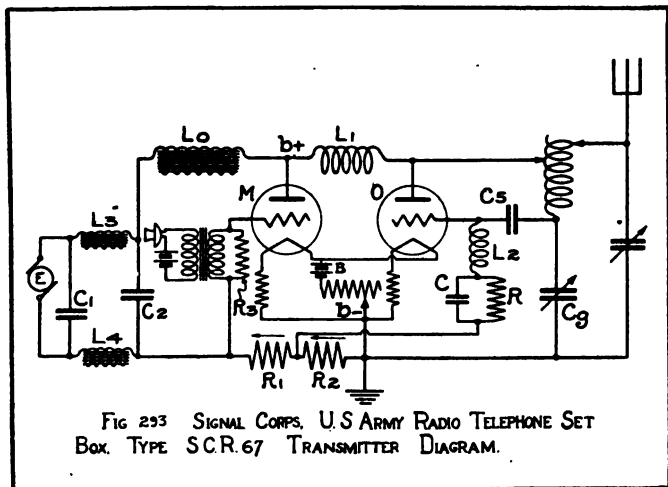

be maintained as in land telephony without throwing an antenna switch from transmitter to receiver. In these sets means are provided so that an outgoing message will not greatly affect the receiver phones, while an incoming message will.

210. Practical Forms of Apparatus.—A schematic diagram of a complete radiotelephone transmitter such as is used by the Signal Corps in short range work is shown in Fig. 293. The generating system, to the right of the points marked $b+$ and $b-$, may be described as a system having the oscillating circuit direct coupled in parallel with the oscillator tube, both being fed through the radio-frequency choke coil L_1 . The feed back

to the grid of the oscillator tube is by capacity coupling. A condenser C_1 serves to transmit the a.c. variation of voltage across C_2 to the grid without having the grid metallically connected to the plate. The radio-frequency choke coil L_2 and the grid condenser C and grid resistance R in parallel are used in adjusting the grid a.c. voltage to produce good operating characteristics; this arrangement produces part of the proper negative voltage on the grid of the generator tube. Resistances R_1 and R_2 make the grid voltages of the modulator and oscillator tubes negative because of the drop of the direct current through them. This method of making the grid negative

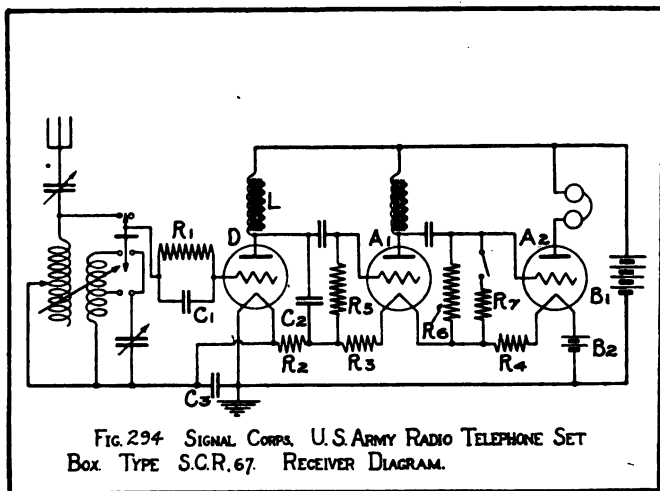

cuts down the effective plate voltage which is supplied to the modulator tubes by the generator. The condensers C_1 , C_2 and choke coils L_1 , L_2 form a filter to eliminate the disturbing effect of the commutator ripple of the direct-current dynamotor.

It will be noted that the connection for this circuit is very similar to that shown in Fig. 290 for modulation by the method of absorption of the output power. By replacing the radio-frequency choke coil L_0 of Fig. 290 by an audio-frequency iron-core choke coil and by putting the radio-frequency choke coil in

the lead between the plates of the tubes, the circuit becomes one of the variable input-power type rather than one of the variable-power absorption type. By the insertion of the radio-frequency choke coil the tube *A* is prevented from consuming radio-frequency power, and by using for L_0 a choke coil of high impedance to audio frequencies the tube is made capable of generating power.

Fig. 294 shows the receiver circuit for the same Signal Corps radiotelephone set for which the transmitter circuit is shown in Fig. 293.

211. Chopper Modulation of Tube Transmitting Sets for Radio Telegraphy.—It has been pointed out above that if continuous waves are to be received with a simple detector they must be modulated at an audio frequency at the transmitting station. In Section 204 modulation by alternating-current plate supply has been described. Another simple and convenient method of making the continuous waves audible is to interrupt them at an audible frequency by a device called a "chopper." The usual type of chopper is simply a metal disk in whose periphery notches are cut, which are filled with an insulating material. A brush makes contact with the periphery of the disk. The disk is rotated at such a speed that the continuous oscillations of radio frequency which are conducted through the brush are interrupted at an easily audible frequency, such as 1000 cycles. This is called "chopper modulation." Another method used in some tube transmitting sets is to modulate the radio-frequency oscillations at an audible frequency by a buzzer; this is "buzzer modulation." There are many circuits which can be used for chopper or for buzzer modulation. In general any transmitting circuit which can be used for radiotelephony can be used for chopper modulation by substituting the chopper and key in series for the microphone.

It is usually found under ordinary operating conditions that if a given electron tube generating set will transmit a given distance when operated with good modulation as a radiotelephone transmitter that it will transmit nearly twice as far when operated as a radiotelegraph transmitter of interrupted continuous waves using a properly adjusted chopper. It is also usually found that if operated as a radiotelegraph transmitter of uninterrupted continuous waves the set will transmit nearly three

times as far as when operated as a radiotelephone. These figures are only approximate. In general, the ratios are a little larger for the transmitting sets of higher power. One reason for increased range with uninterrupted continuous waves is that the heterodyne method of reception is particularly sensitive, as has been pointed out in Section 205.

212. Line Radio Communication.—Continuous waves of radio-frequency can be guided by wires between the transmitting and receiving stations instead of being radiated through space, and when so guided on wires can be used for either telegraphy or telephony. The conducting line does not, to any extent, distort the audiofrequency wave form which is being transmitted. Telephony by the use of modulated radiofrequency currents guided by wires is called "line-radio telephony." Other names which have been applied are "wire-radio telephony," "carrier-frequency telephony," "carrier-current telephony," "guided-wave telephony," and "wired wireless."

Line radiotelephony can be very simply maintained by connecting radiotelephone sets at both ends of a pair of wires instead of to antennas. If a particular radiotelephone transmitting set will maintain satisfactory communication with a particular receiving set over a given distance when its output is radiated through space in ordinary radio communication, it may be expected to maintain satisfactory communication with the same receiving set over a considerably greater distance by line-radio methods, in some cases twenty times as far as in ordinary radiotelephony.

The radiofrequency employed is called the "carrier" frequency, as is the practice in radiotelephony. The carrier frequency used may vary through a wide range, but is usually between 15,000 and 500,000 cycles per second, which is above the range of audible frequencies.

Multiplex Systems.—The transmission by any method of more than one message over one pair of wires at the same time is called "multiplex telegraphy" or "multiplex telephony," as the case may be.

In ordinary telegraphy with wires there are a number of methods of multiplex operation, which have been in use for some time. These methods are described in such books as "Telegraphy," by T. E. Herbert.

For multiplex wire telephony the use of a "phantom circuit" with audio-frequency currents is a method which has been employed for some time and is now in extensive operation. In this method two pairs of wires are made to transmit three telephone messages, using audio-frequency currents, by connecting across the two main circuits at each end the additional "phantom circuit." It is necessary that a balanced condition be secured. If transformers or "repeating coils" are used at each end and taps are brought out from the midpoint of the line winding of each "repeating coil," the "phantom circuit" may be connected across the midpoints of the two windings. Information regarding "phantom-circuit" operation may be found in a book, "Telephone Apparatus," by G. D. Shepardson, and in other books mentioned in section 60-b.

It is possible to transmit both telegraph and telephone messages over the same pair of wires at the same time. Such a line is called a "composite" line.

One of the important advantages of the line-radio method is that it increases the possibilities of multiplex operation in both telegraphy and telephony with respect to the number of messages which can be transmitted simultaneously over a single circuit. That is, on a given line, the line-radio method affords a number of channels which can be used for communication by either telegraphy or telephony, in addition to those available using the older methods. The line-radio method is essentially different from the older methods of multiplexing.

In radiotelephony a considerable number of different conversations can be carried on at the same time in the same locality, if the carrier frequencies used are far enough apart so that the side frequencies (see Section 206, page 509) and the interfering harmonics do not overlap. Likewise, when waves are guided by wires, a number of different conversations can be carried on at the same time if the carrier frequencies are properly selected. Employing guided radio-frequency waves, as many as six conversations have been carried on at the same time over a single pair of wires. On a pair of wires which are being employed for ordinary telephony, for multiplex audio-frequency telephony using phantom circuits, and for composite operation in ordinary telegraphy, a number of additional telephone conversations can be carried on using radio-frequency currents.

Instead of additional conversations using radio-frequency currents, the pair of wires will transmit ten or more additional telegraph messages using radio-frequency carrier currents. The use of radio-frequency currents on the line therefore greatly increases the service obtained from a given pair of wires.

One obvious advantage of line radio communication over ordinary radio communication is the secrecy of the former.

Satisfactory telephone service, whether audio-frequency or radio-frequency currents are employed, evidently requires that it shall be possible to talk in either direction without manipulating any switches. This is known as a "duplex system." This requires that each station shall have the equipment of both a transmitting and a receiving station. In line radiotelephony, one way of securing duplex operation is to employ two different carrier frequencies for transmission in the two directions. The two carrier frequencies are present on the line at the same time, and the resultant wave on the line necessarily has "beats." (See Section 205, page 501.) The frequency of the beats is the difference between the frequencies of the two impressed waves, and if the beat frequency is an audible frequency, a note corresponding to the beat frequency will be heard in the telephone receiver. For this reason it is necessary in line radiotelephony to use very carefully tuned circuits and to have the two frequencies used as carrier frequencies differ by 3,000 or more.

Attenuation.—In transmitting telephonic messages over wires, either in ordinary wire telephony or using radio frequencies, the amplitude of the alternating current is damped out with increasing distances. This effect is sometimes called "attenuation." Attenuation increases with increasing frequency. In ordinary wire telephony the frequencies of the sounds conveyed are likely to vary from 100 to 3,000 cycles per second, and the currents having these different frequencies are transmitted with entirely different attenuations. Therefore, in ordinary wire telephony the listener at the receiving station hears the low notes louder than the high notes. This results in some distortion of the sound. The attenuation of radio-frequency currents on a line is greater than the attenuation of audio-frequency currents because of the higher frequency. But since the extreme difference in frequency of the side waves is small

compared with the carrier frequency itself, all of the side waves are transmitted with nearly the same attenuation, and the distortion is practically absent when radio-frequency currents are used.

For instance, if the wave form of a voice is such that it has a fundamental frequency of 250 vibrations per second and contains harmonics or overtones of a frequency of 1,250 per second, the frequency of the component of the line current corresponding to the harmonic is, in ordinary telephony, five times that corresponding to the fundamental. The harmonic will be attenuated approximately five times as much as the fundamental. With the same voice transmitted by the line radio method, using a carrier frequency of 150,000, the ratio of the frequency due to this particular harmonic of the current (151,250), to the frequency of the current due to the fundamental (150,250) is 1.006. This ratio represents approximately the relative magnitudes of the attenuations of the respective frequencies.

The practical development of line radio communication dates from the pioneer work of Maj. Gen. George O. Squier, Chief Signal Officer of the Army, which is described in his paper, "Multiplex Telephony and Telegraphy by Means of Electric Waves Guided by Wires," *Trans. A. I. E. E.*, vol. 30, p. 1617, May, 1911; also published as a Professional Paper of the Signal Corps.¹

Line radio communication has given a great impetus to the development of the electron tube and tube circuits, and this development of the electron tube has made possible further improvements in line radio communication.

Apparatus.—Essential elements of line radiotelephony, which are not found in ordinary audio-frequency telephony, are a source of radiofrequency alternating current, means for modulating the radiofrequency current, tuned circuits, and a rectifying detector. In line radio-telephony tuned circuits are used at both the transmitting and receiving stations.

A line radiotelephone system can be considered as consisting of three parts—the transmitting apparatus, the connecting line, and the receiving apparatus. The transmitting apparatus is

¹ A copy may be purchased for 15 cents from the Superintendent of Documents, Government Printing Office, Washington, D. C.

very similar to that used for radiotelephony, and employs tuned circuits. The source of undamped high-frequency alternating current may be a high-frequency alternator; it is more usually an electron tube generator. The output of the electron tube generator is usually modulated, as in radiotelephony, by a modulator tube connected to a microphone circuit. The modulated output of the generator is connected to the line. In a multiplex line radiotelephone system where it is necessary to make use of a great number of channels, a device called the "band frequency-filter" has been used, which allows to pass only frequencies within a predetermined band which can be transmitted without distortion. In such multiplex systems the modulated output is then coupled to the line through transformers, and then passes through another "filter." Multiplex line radio communication can, however, be carried on without filters if the carrier frequencies are far enough apart.

The filter is a device for selecting certain frequencies which it is desired to allow to pass, and preventing other frequencies from passing. It is a particular kind of tuning device, and consists of a network of inductances and capacities which offer a low impedance to currents whose frequencies lie within a certain range, and offer very high impedance to currents whose frequencies lie outside that range. The filter is used both at the transmitting station for preventing the modulated output of the generator from putting on to the line frequencies which it is not desired to transmit for that circuit, and at the receiving station for preventing a given circuit from receiving frequencies outside its assigned band of frequencies. The use of filters on multiplex circuits results in much more satisfactory transmission. Some of the principles of filters have been briefly discussed in section 113, page 246. For a further discussion of filters, see the paper by Colpitts and Blackwell mentioned at the end of this section, and also a book by G. W. Pierce, "Electric Oscillations and Electric Waves."

The use in multiplex line radiotelephony of carrier frequencies as close together as 3,000 cycles, as mentioned above, requires very good filters. In multiplex line radiotelegraphy, the carrier frequencies can be even closer together than 3,000 cycles, if the filters are sufficiently selective.

The circuit connecting the transmitting and receiving stations is preferably a metallic circuit. The line may be constructed of copper wire, or aluminum wire, or copper-clad iron wire. Since the carrier frequencies are high frequencies, and therefore the skin effect is appreciable (see Section 117, page 263), and the current is conducted largely near the surface of the wire, the use of copper-clad iron wire is particularly economical with line radiotelephony.

Power lines which are in use for transmitting electrical power, even at high voltages, can at the same time be employed for transmitting radiofrequency currents for line radiotelephony. The telephone circuit can be coupled at the stations to the power line through high-voltage condensers, or the telephone circuit can be run parallel and close to the power line for a short distance at each station.

The trolley wire of an electric railroad can be used to conduct radio-frequency currents for line radio telegraphy or telephony, and communication can thus be carried on from a moving electric car. This application offers possibilities of important improvements in train dispatching on electric railroads.

At the receiving station the incoming current is passed through appropriate filters, if desirable, to a detector tube by means of which the voice is reproduced, as would be done in a radiotelephone receiving set. The receiving apparatus for the transmitted wave forms ordinarily used in line radiotelephony is essentially the same as the receiving apparatus for radiotelegraphy, as described in Sections 180, 194, 198, and may include amplifiers. The circuits are, of course, tuned.

In line radiotelephony, as in ordinary radiotelephony, considerations of efficient transmission require that the modulation shall be complete or nearly complete. For radiotelephony, one kind of completely modulated wave is shown in Fig. 287, and is described in Section 206, page 513, in which the envelopes cross the zero axis, and for which it is necessary to supply at the receiving station local radiofrequency current of the carrier frequency and proper phase relation. This wave form is used to some extent in line radiotelephony, and has the advantage that it allows the use of a smaller current on the line.

A conversation being carried on a pair of wires by radiofrequency currents is not subject to cross talk from adjacent

wires carrying ordinary audio-frequency telephone currents. Two adjacent circuits used for line radiotelephony do not interfere with each other if they are properly transposed and the frequencies are properly selected. Line radiotelephony is, however, subject to interference from high-power radio stations transmitting undamped waves. The telephone line acts somewhat as an antenna and picks up the wave transmitted by the radio station, and the resultant wave on the wire has beats. If the beat frequency is an audible frequency, a note will be heard on the line which may interfere with communication unless the interfering frequency is filtered out. This interference can be avoided by a proper selection of the carrier frequency.

Line radio communication has already been applied to some of the more important long-distance telephone lines in the United States, such as the Harrisburg-Chicago line, and to some lines in Europe, and its use is being extended. The Signal Corps is developing line radio communication for some purposes in field use and for communication with moving trains.

A Signal Corps pamphlet giving a more extended treatment of line radio is in course of preparation. For further study, the reader may consult the following papers: G. O. Squier, *Trans. A. I. E. E.*, vol. 30, p. 1617, May, 1911; R. D. Duncan, jr., *Journal of the Franklin Institute*, vol. 191, p. 23, Jan., 1921; C. A. Culver, *Journal of the Franklin Institute*, vol. 191, p. 301, March, 1921; Colpitts and Blackwell, *Journal A. I. E. E.*, vol. 40, p. 301, April, 1921. An extensive bibliography will be found in the paper by Colpitts and Blackwell.

APPENDIX 1.

SUGGESTED LIST OF LABORATORY EXPERIMENTS.

Experiment 1. Effects Produced by Electric Current.—(a) *Magnetic.*—Put in series a 4-volt storage battery, key, 3-ohm rheostat, and about 2 meters (about 7 ft.) of copper wire of about 1 mm. (0.04 in.) diameter. (For the wire gage number of this wire see Appendix 4.) Place a portion of the copper wire parallel to a small compass needle and 1 cm. (0.4 in.) or more above it. Repeat, with the wire just below the compass needle. Repeat with battery connection reversed. Test out the right-hand rule for direction of current. See Fig. 10, p. 31. Connect a small electromagnet in the circuit, and note behavior like a permanent magnet.

(b) *Heat.*—Take electromagnet out of the circuit and connect in about a half meter of iron wire about $\frac{1}{4}$ mm. in diameter. Reduce resistance in rheostat until all out, and observe iron wire get hot. Shorten iron wire and repeat. Replace iron wire by a short piece of 2-amp. fuse wire. Reduce resistance in rheostat until wire melts.

(c) *Chemical.*—Immerse two copper wires connected to a battery in a vessel containing copper sulphate solution (about 10 per cent, slightly acid). Allow current to flow for some time and note effect.

Experiment 2. Ohm's Law.—(a) *Current inversely proportional to resistance.*—Connect in series a 4-volt storage battery, a milliammeter (10 to 150 milliamperes), and a 400-ohm rheostat. Reduce resistance by about 8 approximately equal steps. Make list of corresponding values of resistance and current.

(b) *Current proportional to emf.*—Connect in series two similar cells, a milliammeter, and about a 40-ohm resistor. Note the current. Take out one cell and note current again. Compute total resistance in circuit in each case.

Experiment 3. Voltmeter-Ammeter Method of Measuring Resistance.—Send enough current through an incandescent lamp to make the filament bright. Measure current by ammeter in series, and voltage by voltmeter connected across the lamp, and

calculate resistance. Measure resistance in this manner of the filament of an electron tube, Signal Corps type VT-1 or type VT-2 tube taking its normal current.

Experiment 4. Use of Wheatstone Bridge.—Connect apparatus of which resistance is desired to the appropriate terminals, which are marked X on the bridges made by some manufacturers. Press battery key, tap galvanometer key lightly. Suitable resistances to measure are those of filaments (cold) of electron tubes, milliammeter, microammeter, field of pack set generator, sliding contact rheostat.

Experiment 5. Series and Parallel Connections.—(a) *Test of*

Relation, $\frac{1}{R} = \frac{1}{r_1} + \frac{1}{r_2}$ or $R = \frac{r_1 r_2}{r_1 + r_2}$.—Apparatus: milliammeter (10 to 150 milliamperes), resistance box, 1 to 50 ohm fixed resistor, 1 dry cell of measured voltage. Measure R of two resistors (say 70 and 50), (a) when they are connected in parallel, and (b) when they are connected in series. Correct for resistance of milliammeter R_a , thus

$$R = \frac{E}{I} - R_a$$

Compare with values given by formula

$$R = \frac{50 \times 70}{120} = 29.1, \text{ etc.}$$

Try similarly 50, 70, and 100 in series and parallel.

(b) *Cells in Parallel.*—To show that polarization is reduced (with moderate current) put 3 ordinary dry cells in parallel. Put the battery in a 15-ohm circuit, with an ammeter, and repeat with 1 cell of the same sort.

Experiment 6. Polarization and Recovery of Dry Batteries.—Connect in series about three small dry cells about an inch and a quarter in diameter, such as Signal Corps Type BA-3. Using them in a circuit with a resistance of 20 ohms for 6 minutes. take open circuit voltage at start and at end of each 2 minutes. Similarly with 15 ohms, 10 ohms, and 5 ohms in succession. Test recovery with voltmeter each 10 minutes after opening circuit, for as long a time as convenient.

Experiment 7. Storage Battery Curves for Charge and Discharge.—Make tests with 4-volt battery used for filament lighting, if available.

(a) *Charging*.—Read charging current and voltage between terminals of battery at regular intervals, recording voltage, current, and time. With each set of readings the charging circuit should be open long enough to read the voltage of the battery with the circuit open. Calculate the apparent internal resistance of the battery for each reading. Measure the specific gravity of the electrolyte by means of a hydrometer at regular intervals during the charge and plot a curve showing the change with time on charge.

(b) *Discharging*.—Take similar readings at frequent intervals at the start and not so frequently later. Present results in curves with time as abscissas.

Experiment 8. Test of Motor-Generator Set or Dynamotor.—

(a) Use a small dynamotor such as Signal Corps Type DM-1. This is run by a 10-volt storage battery and supplies d.c. current at 300 volts. Read input volts and amperes, and generator volts and milliamperes, when external resistance (which is large) is so regulated as to give about eight current values well spaced between 0 and 160 milliamperes. Calculate generator watts and efficiency for each output of current read.

(b) Study connections and make diagram of generator of radio pack set. (See Fig. 184, page 359.)

Experiment 9. Reactance and Impedance.—(a) Given a coil of about 10 ohms and 0.2 henry (spool 3000 turns No. 16 wire, coil 8.5 in. long, 2 in. internal, 5 in. external diam.), connect it to a 60-cycle, 110-v. a.c. line and measure current with an a.c. ammeter. Calculate impedance.

(b) With Wheatstone bridge measure direct current resistance.

(c) From formula, $\text{Impedance} = \sqrt{R^2 + (2\pi fL)^2}$, calculate the value of the reactance and of L .

(d) Attach a generator like that of the pack set to above coil and measure current and voltage. Taking value of L found in (c), calculate value of f for this machine.

Experiment 10. Wavemeter.—(a) *Measuring of an Unknown Wave Length*.—Portable wavemeter, hot-wire ammeter indicator in coupled circuit, or crystal detector and telephones. Suitable unknown circuits, antenna excited oscillating circuit supplied by electron tube. (See Sec. 203.)

(b) *Wavemeter as Source of Known Wave Length.*—Set condenser of wavemeter to a chosen wave length, and excite wavemeter circuit by means of a buzzer. Tune a series circuit containing a fixed inductance coil and a variable condenser to the wavemeter frequency, coupling an untuned hot-wire ammeter circuit (or detector and telephone) to the circuit to be tuned.

(c) *Resonance Curve.*—Arrangement in (b) with hot-wire ammeter or crystal and galvanometer can be used. Observe deflections of the indicator with different settings of the condenser in the circuit to be tuned to resonance, the wavemeter serving as a source of constant frequency during the measurements. Plot the readings of the current indicator as ordinates and the setting of the condenser as abscissas.

Experiment 11. Measurement of Capacity and Inductance Using a Wavemeter.—(a) *Measurement of Capacity.*—With a known variable condenser as a standard, join the unknown condenser in series with an inductance coil, the circuit being provided with an indicator to show resonance. Couple to a wavemeter circuit excited by an electron tube. Vary the frequency of the exciter until the indicator shows that the unknown circuit is in resonance. Replace the unknown condenser by the known, and keeping the exciting frequency unchanged, vary the known variable condenser until the circuit is again in resonance with the exciting circuit. The unknown capacity is equal to the value of the known which has replaced it. Suitable unknown:—variable air condenser, or capacity of an antenna.

(b) *Measurement of Inductance.*—Connect the coil whose inductance L_x is unknown to the variable standard condenser so as to form a resonant circuit, and tune to any desired wave length, as described above. Read the condenser setting for resonance, C_x . Replace the unknown coil by a standard coil of inductance L_s and retune to the same wave length, and read the condenser setting C_s . Then

$$L_x = \frac{L_s C_s}{C_x}$$

(c) *Use of a Calibrated Wavemeter as an Exciter.*—Either inductance or capacity may be measured, provided a standard of inductance or capacity is available. When the test circuit is in resonance, the product of its inductance and capacity may be calculated from the wave length indicated by the wavemeter.

Either the inductance or capacity of the test circuit will be known, or can be derived by measurements of the same kind, starting from the standard.

Experiment 12. Calibration of a Receiving Set, Using a Wavemeter.—Excite a wavemeter by a buzzer. Couple the wavemeter to the inductance coil of the receiving set. With the inductance coil and condenser of the receiving set at any desired settings, vary the wave length emitted by the wavemeter until the sound is a maximum in the telephone of the receiving set. The reading of the wavemeter indicates the wave length for which the set is adjusted, with the inductance and condenser settings in question.

Or, the wavemeter may be adjusted to a chosen wave length, and the combination of inductance, capacity, and coupling determined by experiment, which give the loudest sound in the telephone for this wave length. A record of the results of such an experiment will make it possible for the operator to adjust the apparatus quickly to receive signals of a desired wave length.

Experiment 13. Effect of Resistance on Resonance Curves.—Make measurements for obtaining the form of the resonance curve of a circuit as in Experiment 10. Add a known resistance of a few ohms and obtain a second resonance curve. Increase the resistance again by the same amount and map out a third resonance curve. From the values of the maximum currents in the three curves, and the values of the inserted resistances determine the total resistance in the three cases. Calculate the impedances from the known inductance, capacity, and resistance at several points on each curve, and check the observed currents at those points.

Experiment 14. Inductive Coupling.—(a) Use a wavemeter to map a curve showing the relation between current and wave length in an oscillating circuit which is closely coupled to a spark source. The source and oscillating circuit should preferably be separately tuned to the same frequency. Carry the curve through a great enough range of wave lengths to show the double hump curve. Loosen the coupling and repeat. The humps should be nearer together. By taking a third resonance curve with very loose coupling a single hump may be obtained.

(b) Make similar measurements with the same circuit coupled

to a quenched gap source, both with close coupling and loose coupling.

(c) Measure the coefficient of coupling in any one of these cases. To do this, measure, as in experiment 11, the following: (1) the inductance of each of the coupled coils giving values L_1 and L_2 ; (2) the inductance of the two coils joined in series, giving L' ; (3) the inductance of the two coils in series with the connections of one reversed, giving L'' . Then if L' is the larger value, the mutual inductance M is given by $M = \frac{L' - L''}{4}$ and the coefficient of coupling is $k = \frac{M}{\sqrt{L_1 L_2}}$.

Experiment 15. Measurement of Decrement.—The circuit whose decrement is to be measured is excited by an electron tube or some damped source of known decrement. The capacity of the circuit is varied until the circuit is in resonance as shown by its current indicator, which should give readings proportional to the current squared. Having read the capacity for resonance, increase it or decrease it until the current squared is only one-half of its maximum value and again read the capacity. The sum of the decrements of the unknown circuit and the source may then be calculated. If an electron tube source is used its decrement is zero. If a decimeter is available, use it to measure the decrement of a transmitting antenna. Note the effect of adding resistance to the circuit, and of adding inductance, retuning of course in the latter case. For methods of calculation and additional information see Bureau of Standards Circular 74, pp. 180 to 190. Check the decrement of a circuit here measured by the method of Experiment 16, calculating decrement from the resistance, capacity, and inductance of the circuit.

Experiment 16. High-Frequency Resistance of Conductors.—The wire or coil whose resistance is to be measured is made part of a resonant circuit, which includes a thermoelement and galvanometer to measure relative values of the square of the current. The circuit is excited by coupling to an electron tube source, and the capacity or inductance adjusted until the thermoelement shows a maximum current, which is recorded. A known resistance is then added, and the maximum current again noted. The total resistance of the circuit is then calculated. Similar

measurements of the total resistance are made with the unknown resistance removed, the circuit being retuned to give maximum current. The resistance of the unknown is obtained by subtraction. The wave length of the source may be obtained by a wavemeter. The direct current resistance of the unknown should be measured with a Wheatstone bridge.

Measure the resistance of the unknown at several wave lengths and calculate the resistance ratios. (See Sec. 117, page 263, and Bureau of Standards Circular 74, Sec. 74.) Plot the resistance-ratio as ordinates, and the reciprocal of the wave length as abscissas.

Suitable objects for test: copper wire, single layer coil, piece of metal strip, antenna. Extension of experiment: measure a resistance by the method of Experiment 15.

Experiment 17. Measurement of Constants of an Antenna.—

(a) *Capacity*.—Measure the wave length of the antenna with a suitable loading coil in series. Replace the antenna and ground leads by the variable standard condenser and tune the circuit to the same wave length. The reading of the condenser then gives the effective capacity of the antenna at that wave length. Repeat this measurement over a wide range of wave lengths.

(b) *Inductance*.—Measure the wave length λ_1 of the circuit composed of the antenna connected with a coil whose inductance L_1 is known. Replace the coil by a second coil whose inductance L_2 is also known and measure the wave length λ_2 . The antenna inductance is then given by the equation

$$L_a = \frac{L_2\lambda_1^2 - L_1\lambda_2^2}{\lambda_2^2 - \lambda_1^2}$$

(c) *Fundamental Wave Length*.—Connect into the antenna circuit a loading coil of a few turns, so that the number of turns in the coil can be readily varied. Measure wave lengths for successively smaller numbers of turns and plot a curve using number of turns as abscissas and wave lengths as ordinates. The wave length corresponding to zero number of turns, as shown by the extended curve, is the fundamental of the antenna and should correspond with the value obtained by calculation from the values of capacity and inductance as determined above.

(d) *Resistance*.—Connect the antenna to the transmitting set with an ammeter in the ground lead. Read the current I in the antenna when operating normally. Then insert a known resistance R of a few ohms in series in the ground lead and read the current I_1 . Then the antenna resistance is given by the equation

$$R_a = \frac{R}{\frac{I}{I_1} - 1}$$

Repeat the above measurement at several wave lengths, using various values of R at each wave length.

Methods of measurement of capacity, inductance and resistance, are described in Section 171, page 389.

Experiment 18. Study of Rectifiers.—(a) Arrange a voltage divider in the circuit of a steady battery, with a voltmeter to measure the voltage taken off to a circuit which includes a crystal rectifier in series with a galvanometer or other instrument capable of detecting currents of a few microamperes. A reversing switch may be employed to reverse the direction of the current through the crystal. Measure the current through the crystal for each direction of the voltage and for a number of values of voltage up to 20 volts. Measure the currents for the same values of alternating voltages of 60 cycles.

(b) Make similar tests with a small electron tube. Note which way the current flows through the tube and compare with theory.

(c) Examine and trace out the connections of a tungar rectifier. Measure the current and voltage on the a.c. end and the current and voltage on the d.c. end. Note how the alternating current varies as the direct current load is varied.

Experiment 19. Characteristic Curves of Small Receiving Tube with Constant Filament Current.—The tube used may be a Signal Corps Type VT-1 tube, or other standard receiving tube. Connect up the tube with a rheostat and ammeter in the filament circuit, so that the filament current may be adjusted to its normal value and held constant. Arrange a battery of 5 to 10 volts with a voltage divider so connected that the grid voltage may be made positive or negative with respect to the filament. The voltage divider allows its value to be adjusted in small steps. The plate battery should consist of a sufficient number

of cells to permit the operation of the tube under normal working conditions. A suitable low-reading milliammeter or calibrated galvanometer should be included in the plate circuit. The grid circuit will require a galvanometer to read the small grid current. A low-reading voltmeter will be necessary to measure the grid voltage.

Adjust the plate voltage to the normal value for the tube in question and, keeping it constant, vary the grid voltage in steps, recording for each setting the plate and grid currents and plate voltage. Plot the plate current as ordinates with grid voltages as abscissas. Make a second curve with grid currents as ordinates and grid voltages as abscissas.

Obtain similar characteristic curves with the plate voltage adjusted to other values lower than the normal voltage.

Experiment 20. Characteristic Curves of Small Receiving Tube as Changed by a Signal.—Arrange a circuit containing a coil, a key, and sufficient resistance so that the current which will flow when connection is made to a 60-cycle, 110-volt line will be only a few tenths of an ampere. The apparatus used in the previous experiment is also to be changed only to the extent of including an inductance in the grid circuit.

Bring up the coil which is carrying the 60-cycle current from a distance until the coupling is sufficient to cause a moderate change in the plate and grid circuits. Adjusting the grid voltage to different values, observe the plate and grid currents, both when the key is open and when it is closed. Plot in two curves the changes in plate current and grid current as ordinates against grid voltages as abscissas. Draw conclusions as to the most suitable values of grid voltage in order that such signals may produce the greatest changes in the plate current and in order that the tube may be a good rectifier.

Experiment 21. Small Transmitting Tube as Source of Oscillations.—The tube used may be a Signal Corps Type VT-2 tube of rated output of five watts, or other small transmitting tube. Connect the tube as in Fig. 280 with a hot-wire ammeter in the oscillation circuit, and with a given setting of the condenser in the oscillation circuit vary the coupling until the ammeter indicates the maximum current. Record this and measure the wave length of the oscillations by means of a wavemeter. Adjust the circuit to other wave lengths, recording the maximum

current which can be obtained in each case. Make similar tests with the other schemes of connection shown in Bureau of Standards Circular 74, Figs. 147 and 148.

Experiment 22. Heterodyne Reception. See Section 205, page 501.—Arrange an electron tube circuit to act as a transmitter of oscillations. These oscillations are to be received in a second circuit in which independent oscillations may be produced. The latter circuit may be that of an oscillating electron tube, connected as in Bureau of Standards Circular 74, Fig. 145. The receiving circuit and the circuit which is transmitting signals should be tuned to the same frequency by a preliminary test with a wavemeter. Start the receiving tube to oscillate and then increase the coupling to the source of signals. Vary the inductance or capacity in the receiving circuit a very little. The pitch of the note received in the telephones should be very sensitive to the smallest change of inductance or capacity, and it should be easy to make it pass from the lowest to the highest audible frequency. Try to adjust the receiving circuit without the preliminary tuning of the transmitting and receiving circuits.

Experiment 23. Power Input Modulation of Electron Tube Generator.—Set up an oscillating circuit of any of the types described in Section 202, page 491, providing means for varying the plate-battery voltage. Record antenna current and plate-battery current, as the plate-battery voltage is continuously varied from normal value to zero, leaving all other adjustments fixed. Determine the settings of the adjustments other than the filament current such that oscillations will be produced at low plate voltages. *Caution.*—Do not use plate voltages higher than the regular rated voltage.

APPENDIX 2.

UNITS.

Every measurement must be expressed in terms of two factors. One of these is a definite amount of the thing measured, called the unit; the other is a mere number, being the number of times the unit is taken. Thus we speak of a certain action taking place in 15 seconds. The second is the unit in which the time specified is measured. A standard is a different thing from a unit; it is the representation of a unit. It is necessary that there be authoritative standards representing certain units. When a length is measured by a number of different measuring sticks, differences in the results can sometimes be detected. The true length would be given by comparison with some one measuring stick that had been agreed upon as the standard. The standards representing various units, for the use of the United States, are kept at the Bureau of Standards in Washington. Measurements are frequently made in ordinary work without any reference to the existence of a standard. A standard can be destroyed and the unit still be used as before. While in many measuring processes standards are actually used (as, for example, in weighing on a balance, the weights used on one side are actually standards), in many other measuring processes standards are not used, but instead marks upon a measuring instrument enable one to express the measurement in terms of units. Thus, a voltmeter is a means of measuring voltage, and the resulting measurements are expressed in terms of a unit called the volt.

Electrical units are based upon the units of the metric system, which is the name given to the system of units used on the Continent of Europe; it is a much simpler system than the English and American systems of units. The fundamental units in the metric system are the meter, the gram, and the second. The "meter" is defined as the length of a certain metal standard bar which is preserved at an international bureau near Paris. The "gram" is a thousandth part of a certain mass of metal kept as a standard of mass at the same place. Each

Government has copies of these two fundamental standards. The "second" is the familiar unit of time.

These units are comparatively familiar to the radio man. Thus the meter is universally used for the expression of the length of radio waves. The meter is a little more than one yard in length. The gram is not far from one-thirtieth of an ounce. The relations between these units and the American and English units are given approximately in the following:

- 1 inch=2.540 centimeters=25.40 millimeters.
- 1 foot=30.48 centimeters=0.3048 meter.
- 1 yard=91.44 centimeters=0.9144 meter.
- 1 mile=1.609 kilometers=1609 meters.
- 1 ounce (avoirdupois)=28.35 grams.
- 1 pound=0.4536 kilogram=453.6 grams.
- 1 liquid quart=0.9463 liter.
- 1 dry quart=1.101 liters.
- 1 millimeter=0.03937 inch.
- 1 centimeter=0.3937 inch.
- 1 meter=3.281 feet=1.094 yards.
- 1 kilometer=0.6214 mile.
- 1 gram=15.43 grains=0.03527 ounce (avoirdupois).
- 1 kilogram=2.205 pounds.
- 1 liter=1.057 liquid quarts=0.2642 gallon.
- 1 hectoliter=90.81 dry quarts=2.838 bushels.

In connection with the units of the metric system the prefixes given below are used to indicate smaller or larger units. Besides those listed, the prefix "pico" (abbreviation p) is coming into use to mean the 10^{-12} part, that is, one million-millionth. Thus, "pico" means the same as "micromicro," which latter is abbreviated $\mu\mu$.

Prefix.	Abbreviation.	Meaning.
micro	μ	One millionth
milli	m	One thousandth
centi	c	One hundredth
deci	d	One tenth
deka	dk	Ten
hekto	h	One hundred
kilo	k	One thousand
mega	M	One million

Without giving any historical information as to the development of electric and magnetic units, it may be said that those now used are the so-called international electric units. The international units are based on four fundamental units—the ohm, ampere, centimeter, and second. The first of these is the unit of resistance, and is defined in terms of the resistance of a very pure conductor of specified dimensions. The ampere is the unit of current and is defined in terms of a chemical effect of electric current, the amount of silver deposited from a certain solution for a current flow for a definite time. The other electric units follow from these in accordance with the principles of electrical science. Some of the units thus defined are given in the following definitions, which are those adopted by international congresses of science and universally used in electrical work.

The "ohm" is the resistance of a thread of mercury at the temperature of melting ice, 14.4521 grams in mass, of uniform cross section and a length of 106.300 centimeters.

The "ampere" is the current which when passed through a solution of nitrate of silver in water in accordance with certain specifications deposits silver at the rate of 0.00111800 of a gram per second.

The "volt" is the electromotive force which produces a current of one ampere when steadily applied to a conductor the resistance of which is one ohm.

The "coulomb" is the quantity of electricity transferred by a current of one ampere in one second.

The "farad" is the capacity of a condenser in which a potential difference of one volt causes it to have a charge of one coulomb of electricity.

The "henry" is the inductance in a circuit in which the electromotive force induced is one volt when the inducing current varies at the rate of one ampere per second.

The "watt" is the power expended by a current of one ampere in a resistance of one ohm.

The "joule" is the energy expended in one second by a flow of one ampere in one ohm.

The watt and joule are not primarily electric units, but they need to be learned in connection with electric units because the

energy required or the power expended in electrical processes are among the most important phases of the actions.

The "horsepower" is sometimes used as a unit of power in rating electrical machinery. The horsepower is equal to 746 watts.

The "gram-calorie," or simply "calorie," is the energy required to raise one gram of water one degree centigrade in temperature. One gram-calorie is, very nearly, equal to 4.18 joules.

Another unit of quantity of electricity, in addition to the coulomb, is the "ampere-hour," which is the quantity of electricity transferred by a current of one ampere in one hour, and is therefore equal to 3600 coulombs.

The units of capacity actually used in radio work are the "microfarad" (a millionth of a farad) and the "micromicrofarad" (a millionth of a microfarad), since the farad is found to be too large a unit. Another unit sometimes used is the "C. G. S. electrostatic unit of capacity," often called the "centimeter of capacity," which is approximately equal to 1.11 microfarads.

The units of inductance commonly used in radio work are the the "millihenry" (a thousandth of a henry) and the "microhenry" (a millionth of a henry). Another unit sometimes used is the "centimeter of inductance," which is one one-thousandth of a microhenry.

For further information regarding electric and magnetic units see Bureau of Standards Circular No. 60, Electric Units and Standards (price 15 cents), and Bureau of Standards Scientific Paper No. 292, International System of Electric and Magnetic Units (price 10 cents). These publications can be purchased from the Superintendent of Documents, Government Printing Office, Washington, D. C. Other Government publications of electrical and radio interest are listed in Price List 64 issued by the Superintendent of Documents, of which he will send a copy on request. See also pages 569, 572.

ABBREVIATIONS OF UNITS.











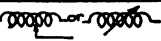









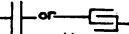





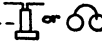

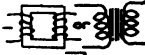

Unit.	Abbreviation.	Unit.	Abbreviation.
amperes	amp.	kilometers	km
ampere-hours	amp-hr.	kilowatts	kw
centimeters	cm	kilowatt-hours	kw-hr
centimeter-gram-second	cgs	kilovolt-amperes	kva
cubic centimeters	cm ³	meters	m
cubic inches	cu. in.	microfarads	μf
cycles per second	~	micromicrofarads	$\mu\mu f$
degrees Centigrade	° C	millihenries	mh
degrees Fahrenheit	° F	millimeters	mm
feet	ft.	pounds	lb.
foot-pounds	ft-lb.	seconds	sec.
grams	g	square centimeters	cm ²
henries	h	square inches	sq. in.
inches	in.	volts	v
kilograms	kg	watts	w

APPENDIX 3.

SYMBOLS USED FOR PHYSICAL QUANTITIES.

Physical Quantity.	Symbol.	Physical Quantity.	Symbol.
area.....	S or A	magnetic flux.....	ϕ
base of napierian logarithms=2.718.....	e	magnetic induction.....	B
capacity.....	C	mass.....	m
conductance.....	g	mutual inductance.....	M
coupling coefficient.....	k	number of revolutions.....	n
current, instantaneous value.....	i	period of a complete oscillation.....	T
current, effective value.....	I	permeability.....	μ
decrement.....	δ	phase angle.....	θ
density.....	d	phase difference.....	ψ
dielectric constant.....	K	potential difference.....	V
electric field intensity.....	E	power, instantaneous value.....	p
electromotive force, instantaneous value.....	e	power, average value.....	P
electromotive force, effective value.....	E	quantity of electricity.....	Q
energy.....	W	ratio circumference of circle to diameter=3.1416.....	π
force.....	F	reactance.....	X
frequency.....	f	resistance.....	R
frequency $\times 2\pi$	ω	temperature coefficient.....	α
gravity, acceleration of height.....	g	time.....	t
impedance.....	Z	velocity.....	v
inductance, self.....	L	velocity of light.....	c
length.....	l	wave length.....	λ
magnetic field intensity.....	H	wave length in meters.....	λ_m
		work.....	W

•KEY TO SYMBOLS OF APPARATUS•

Alternator		Variable Inductor	
Ammeter		Key	
Antenna		Resistor	
Arc		Variable resistor	
Battery		Switch S.P.S.T.	
Buzzer		S.P.D.T.	
Condenser		D.P.S.T.	
Variable Condenser		D.P.D.T.	
Connection of wires		reversing	
No connection		Telephone receiver	
Coupled Coils		Telephone transmitter	
Variable coupling		Thermoelement	
Detector		Transformer	
Galvanometer		Electron tube	
Gap, plain		Voltmeter	
Gap, quenched			
Ground			
Inductor			

APPENDIX 4.

COPPER WIRE TABLES.

DIAMETERS OF BARE WIRE AND OUTSIDE DIAMETERS OF INSULATED
WIRE.

The sizes shown are American Wire Gage (Brown & Sharpe).
Diameters in thousandths of an inch.
Data on insulated wires supplied by Belden Manufacturing Co.

Size.	Bare.	Enamel.	Single cotton.	Double cotton.	Single silk.	Double silk.
8.....	128.5	130.60	135.5	141.5		
9.....	114.4	116.50	121.4	127.4		
10.....	101.9	104.00	107.9	112.9		
11.....	90.74	92.70	96.7	101.7		
12.....	80.81	82.80	86.8	91.8		
13.....	71.96	74.00	78.0	83.0		
14.....	64.08	66.10	70.1	75.1		
15.....	57.07	59.10	63.1	68.1		
16.....	50.82	52.80	55.8	60.8	52.8	54.6
17.....	45.26	47.00	50.3	55.3	47.3	49.1
18.....	40.30	42.10	45.3	50.3	42.3	44.1
19.....	35.89	37.70	40.9	45.9	37.9	39.7
20.....	31.96	33.70	37.0	42.0	34.0	35.8
21.....	28.46	30.20	33.5	38.5	30.5	32.3
22.....	25.35	26.90	29.3	33.3	27.3	29.1
23.....	22.57	24.10	26.6	30.6	24.6	26.4
24.....	20.10	21.50	24.1	28.1	22.1	23.9
25.....	17.90	19.20	21.9	25.9	19.9	21.7
26.....	15.94	17.10	19.9	23.9	17.9	19.7
27.....	14.20	15.30	18.2	22.2	16.2	18.0
28.....	12.64	13.60	16.6	20.6	14.6	16.4
29.....	11.26	12.20	15.3	19.3	13.3	15.1
30.....	10.03	10.90	14.0	18.0	12.0	13.8
31.....	8.928	9.70	12.9	16.9	10.9	12.7
32.....	7.950	8.70	11.95	15.95	9.95	11.75
33.....	7.080	7.70	11.08	15.08	9.08	10.88
34.....	6.305	6.90	10.30	14.30	8.30	10.10
35.....	5.615	6.20	9.61	13.61	7.61	9.41
36.....	5.000	5.50	9.00	13.00	7.00	8.80
37.....	4.453	4.90	8.45	12.45	6.45	8.25
38.....	3.965	4.40	7.96	11.96	5.96	7.76
39.....	3.531	3.90	7.53	11.53	5.53	7.33
40.....	3.145	3.50	7.14	11.14	5.14	6.94

WEIGHT OF BARE AND INSULATED COPPER WIRE.

(In pounds per 1000 feet at 68° Fahrenheit. The sizes shown are American Wire Gage (Brown & Sharpe). Data on insulated wires supplied by Belden Manufacturing Co.)

Size.	Bare.	Enamel.	Single cotton.	Double cotton.	Single silk.	Double silk.
8....	50.0	50.55	50.60	51.15
9....	39.63	40.15	40.15	40.60
10....	31.43	31.80	31.85	32.18
11....	24.92	25.25	25.30	25.60
12....	19.77	20.05	20.10	20.40
13....	15.68	15.90	15.99	16.20
14....	12.43	12.60	12.73	12.91
15....	9.858	10.00	10.10	10.33
16....	7.818	7.930	8.025	8.210	7.890	7.955
17....	6.200	6.275	6.395	6.540	6.260	6.315
18....	4.917	4.980	5.080	5.235	4.970	5.015
19....	3.899	3.955	4.035	4.220	3.940	3.990
20....	3.092	3.135	3.218	3.373	3.132	3.173
21....	2.452	2.490	2.561	2.685	2.488	2.520
22....	1.945	1.970	2.048	2.168	1.976	2.006
23....	1.542	1.565	1.635	1.727	1.570	1.593
24....	1.223	1.245	1.304	1.398	1.247	1.272
25....	0.9699	0.988	1.039	1.129	0.994	1.018
26....	0.7692	0.7845	0.8335	0.9140	0.7905	0.8100
27....	.6100	.6220	.6660	.7560	.6280	.6450
28....	.4837	.4940	.5325	.6075	.4980	.5140
29....	.3836	.3915	.4255	.4890	.3970	.4130
30....	.3042	.3105	.3400	.3955	.3160	.3330
31....	.2413	.2465	.2762	.3257	.2517	.2678
32....	.1913	.1960	.2230	.2700	.2100	.2170
33....	.1517	.1550	.1816	.2270	.1611	.1750
34....	.1203	.1230	.1478	.1928	.1290	.1412
35....	.09542	.0980	.1202	.1600	.1035	.1130
36....	.07568	.0776	.0994	.1361	.0823	.0920
37....	.0601	.0616	.0822	.1204	.0663	.0740
38....	.04759	.0488	.0702	.1049	.0534	.0623
39....	.03774	.0387	.0602	.0937	.0424	.0504
40....	.02990	.0307	.0519	.0838	.0345	.0429

RESISTANCE OF COPPER WIRE.

Standard annealed copper, solid conductor, at 68° Fahrenheit. For direct current and for alternating current of frequency of 1,500,000 cycles per second (wave length = 200 meters). The sizes shown are American wire gage (Brown & Sharpe).

Size.	Ohms per 1000 feet.		Size.	Ohms per 1000 feet.	
	D. C. ¹	At 200 m. ²		D. C. ¹	At 200 m. ²
00.....	0.07793	3.369	20.....	10.15	40.88
0.....	.09827	3.784	21.....	12.80	46.30
1.....	.1239	4.254	22.....	16.14	52.50
2.....	.1563	4.784	23.....	20.36	59.55
3.....	.1970	5.374	24.....	25.67	67.72
4.....	.2485	6.045	25.....	32.37	77.0
5.....	.3133	6.798	26.....	40.81	87.8
6.....	.3951	7.64	27.....	51.47	100.2
7.....	.4982	8.60	28.....	64.90	114.1
8.....	.6282	9.67	29.....	81.83	129.7
9.....	.7921	10.88	30.....	103.2	148.0
10.....	.9989	12.24	31.....	130.1	170.3
11.....	1.260	13.79	32.....	164.1	199.2
12.....	1.588	15.54	33.....	206.9	236.5
13.....	2.003	17.49	34.....	260.9	285.2
14.....	2.525	19.72	35.....	329.0	348.7
15.....	3.184	22.22	36.....	414.8	431.4
16.....	4.016	25.10	37.....	523.1	536.2
17.....	5.064	28.32	38.....	659.6	670.0
18.....	6.385	32.00	39.....	831.8	840.1
19.....	8.051	36.10	40.....	1049.	1055.7

¹ Complete tables of the direct-current resistance of copper wire are given in Bureau of Standards Circular No. 31, "Copper Wire Tables."

² Resistance for undamped alternating current of frequency of 1,500,000 cycles per second, of single straight cylindrical solid conductor, with no adjacent conductors or capacity areas. The values given take into account the skin effect and are computed according to the method described on p. 174 of Bureau of Standards Scientific Paper No. 169. Approximate values of resistance for wave lengths in the neighborhood of 200 meters for sizes of wire from No. 00 to No. 28 may be obtained by multiplying the resistance at 200 meters by 14.14 and dividing by the square root of the wave length. In actual radio apparatus the increase in effective resistance due to capacity effects may be considerably more than the increase in effective resistance due to skin effect, which is the only effect considered in computing the above values. For further information regarding high-frequency resistance reference may be made to Bureau of Standards Circular No. 74 and to Bureau of Standards Scientific Paper No. 169.

APPENDIX 5.

Table Showing the Relation of Wave Length, Frequency, and the Product of Inductance and Capacity, in Oscillatory Circuits.

λ =wave length in meters.

f =frequency, number of complete oscillations per second.

(The values in the table must be multiplied by 1000.)

$\omega=2\pi$ times the frequency. ($=6.28f$). (The values in the table must be multiplied by 1000).

L =inductance in centimeters (1000 cms. of inductance=1 microhenry.)

C =capacity in microfarads.

In this table are shown the relations existing between wave length, frequency, and the product of inductance and capacity, for circuits having wave lengths from 1 meter to 50,000 meters. The values of f , ω , and CL are correct to about 1 part in 200. The following examples illustrate some of the uses of the table.

Example 1.—Find the capacity which must be connected in series with an inductance of 500,000 centimeters (500 microhenries) in order to tune to 2500 meters. In the table opposite 2500 meters we find for LC a value of 1760, which divided by 500,000 yields a quotient of 0.00352. The capacity which must be used is therefore 0.00352 microfarads.

Example 2.—What inductance must be placed in series with a condenser of 0.005 microfarad in order that the circuit may have a wave length of 600 meters? In the table opposite 600 meters we find for LC a value of 101.4, which divided by 0.005 yields a quotient of 20,280. The inductance which must be used is therefore 20,280 centimeters, or 20.28 microhenries.

Example 3.—Find the wave length of a circuit having a capacity of 0.0001 microfarad, and an inductance of 101,600 centimeters (101.6 microhenries). The product of the inductance and the capacity is $101,600 \times 0.0001 = 10.16$. In the column headed " LC " we find that a value of $LC = 10.16$ corresponds to a wave length of 190 meters.

Table Showing the Relation of Wave Length, Frequency, and the Product of Inductance and Capacity, in Oscillatory Circuits.

λ Wave length meters	f Multiply values below by 1000	ω Multiply values below by 1000	CL C in μf L in cm	λ Wave length meters	f Multiply values below by 1000	ω Multiply values below by 1000	CL C in μf L in cm
1	300000	1884000	0.0008	200	1500	9420	11.26
2	150000	942000	.0011	205	1463	9190	11.83
3	100000	628000	.0018	210	1429	8970	12.41
4	75000	471000	.0045	215	1395	8760	13.01
5	60000	377000	.0057	220	1364	8560	13.62
6	50000	314200	.0101	225	1333	8370	14.25
7	42900	269000	.0138	230	1304	8190	14.89
8	37500	235500	.0180	235	1277	8020	15.55
9	33330	209400	.0228	240	1250	7850	16.22
				245	1225	7690	16.90
10	30000	188400	.0282				
15	20000	125600	.0635	250	1200	7540	17.60
20	15000	94200	.1129	255	1177	7390	18.31
25	12000	75400	.1755	260	1154	7250	19.03
30	10000	62800	.2530	265	1132	7110	19.77
35	8570	53800	.3446	270	1111	6980	20.52
40	7500	47100	.450	275	1091	6860	21.29
45	6670	41900	.570	280	1071	6740	22.07
				285	1053	6620	22.87
50	6000	37700	.704	290	1035	6500	23.66
55	5450	34220	.852	295	1017	6380	24.50
60	5000	31420	1.014				
65	4620	28970	1.188	300	1000	6280	25.33
70	4290	26900	1.378	310	968	6080	27.05
75	4000	25120	1.583	320	938	5890	28.83
80	3750	23520	1.801	330	909	5700	30.66
85	3529	22120	2.034	340	882	5540	32.55
90	3333	20920	2.280	350	857	5380	34.48
95	3158	19830	2.541	360	833	5230	36.48
				370	811	5090	38.54
100	3000	18840	2.816	380	790	4953	40.7
105	2857	17940	3.105	390	769	4830	42.8
110	2727	17130	3.404				
115	2609	16380	3.721	400	750	4710	45.0
120	2500	15710	4.05	410	732	4590	47.3
125	2400	15070	4.40	420	714	4480	49.7
130	2308	14480	4.76	430	698	4380	52.0
135	2222	13950	5.13	440	682	4280	54.5
140	2144	13450	5.52	450	667	4190	57.0
145	2069	12980	5.92	460	652	4100	59.6
				470	638	4010	62.3
150	2000	12560	6.34	480	625	3920	64.8
155	1935	12150	6.76	490	612	3842	67.6
160	1875	11770	7.20				
165	1818	11410	7.66	500	600	3766	70.4
170	1765	11080	8.13	510	588	3692	73.3
175	1714	10760	8.62	520	577	3620	76.0
180	1667	10470	9.12	530	566	3552	79.0
185	1622	10180	9.63	540	556	3485	82.1
190	1579	9910	10.16	550	545	3422	85.2
195	1538	9660	10.71	560	536	3361	88.4

WAVE LENGTH TABLES.

559

Table Showing the Relation of Wave Length, Frequency, and the Product of Inductance and Capacity, in Oscillatory Circuits—Continued.

λ Wave length meters	f Multiply values below by 1000	ω Multiply values below by 1000	CL C in μ f L in cm	λ Wave length meters	f Multiply values below by 1000	ω Multiply values below by 1000	CL C in μ f L in cm
570	526	3302	91.4	1150	200.9	1637	372.1
580	517	3246	94.7	1200	250.0	1570	405
590	509	3193	98.0	1250	240.0	1506	440
				1300	230.8	1448	476
600	500	3140	101.4	1350	222.2	1395	513
610	492	3088	104.7	1400	214.4	1346	552
620	484	3038	108.2	1450	206.9	1298	592
630	476	2990	111.7				
640	469	2942	115.4	1500	200.0	1256	634
650	462	2896	118.8	1550	193.5	1215	676
660	455	2852	122.5	1600	187.5	1177	720
670	448	2810	126.3	1650	181.8	1142	766
680	441	2768	130.2	1700	176.5	1108	813
690	435	2730	134.1	1750	171.4	1076	862
				1800	166.7	1046	912
700	429	2692	137.8	1850	162.2	1017	963
710	423	2654	141.9	1900	157.9	990	1016
720	417	2616	145.9	1950	153.8	965	1071
730	411	2580	150.0				
740	405	2544	154.0	2000	150.0	942	1126
750	400	2510	158.3	2050	146.3	920	1183
760	394.8	2476	162.6	2100	142.9	898	1241
770	389.6	2443	166.8	2150	139.5	876	1301
780	384.6	2412	171.4	2200	136.4	856	1362
790	379.8	2382	175.6	2250	133.3	838	1425
				2300	130.4	819	1489
800	375.0	2353	180.1	2350	127.7	801	1555
810	370.4	2325	184.7	2400	125.0	784	1622
820	365.9	2297	189.3	2450	122.5	768	1690
830	361.4	2270	194.0				
840	357.1	2242	198.5	2500	120.0	753	1760
850	352.9	2214	203.4	2550	117.7	738	1831
860	348.8	2188	208.2	2600	115.4	724	1903
870	344.8	2162	213.2	2650	113.2	710	1977
880	340.9	2138	217.9	2700	111.1	697	2052
890	337.1	2115	222.9	2750	109.1	684	2129
				2800	107.1	672	2207
900	333.3	2092	228.0	2850	105.3	660	2287
910	329.7	2070	233.2	2900	103.5	648	2366
920	326.1	2047	238.1	2950	101.7	638	2450
930	322.6	2024	243.4				
940	319.1	2003	248.7	3000	100.0	628	2533
950	315.8	1982	254.1	3500	85.7	538	3448
960	312.5	1962	259.5	4000	75.0	471	4500
970	309.3	1942	264.7	4500	66.7	418	5700
980	306.1	1922	270.4	5000	60.0	377.	7040
990	303.0	1902	275.9	5500	54.5	342.2	8520
				6000	50.0	314.2	10140
1000	300.0	1884	281.6	6500	46.2	289.8	11880
1050	285.7	1794	310.5	7000	42.9	268.8	13780
1100	272.7	1712	340.4	7500	40.0	251.0	15830

Table Showing the Relation of Wave Length, Frequency, and the Product of Inductance and Capacity, in Oscillatory Circuits—Continued.

λ Wave length meters	f Multiply values below by 1000	ω Multiply values below by 1000	CL C in μf L in cm	λ Wave length meters	f Multiply values below by 1000	ω Multiply values below by 1000	CL C in μf L in cm
8000	37.50	235.2	18010	25000	12.00	75.4	176000
8500	35.29	221.4	20340	30000	10.00	62.8	253300
9000	33.33	209.2	22800	35000	8.57	53.8	344800
9500	31.58	198.2	25410	40000	7.50	47.1	450000
10000	30.00	188.4	28160	45000	6.67	41.8	570000
15000	20.00	125.7	63400	50000	6.00	37.7	704000
20000	15.00	94.2	112600				

APPENDIX 6.

RADIO LAWS AND REGULATIONS.

Every person engaged in the handling of radio traffic should be thoroughly familiar with the radio communication laws of the United States and the International Radiotelegraphic Convention. These are printed in a pamphlet, Radio Communication Laws of the United States, of which copies may be purchased for 15 cents each from the Superintendent of Documents, Government Printing Office, Washington, D. C.

The law provides that in order to operate a radio transmitting station, both a *station* license, and an *operator* license must be secured. The law provides penalties for the operation of a transmitting station without proper licenses.

Provision is now made for eight classes of land stations:

- (1) Public Service Stations, General.
- (2) Public Service Stations, Limited.
- (3) Limited Commercial Stations.
- (4) Experiment Stations.
- (5) Technical and Training-School Stations.
- (6) Special Amateur Stations.
- (7) General Amateur Stations.
- (8) Restricted Amateur Stations.

Station licenses for Classes 4, 5, and 6 are issued only under exceptional circumstances, as set forth in the pamphlet mentioned above.

General amateur stations are restricted to a transmitting wave length not exceeding 200 meters and a transformer input not exceeding 1 kilowatt.

Restricted amateur stations are amateur stations located within five nautical miles of a naval or military station and are restricted to a wave length not exceeding 200 meters and to a transformer input not exceeding one-half kilowatt.

If a transmitting station radiates more than one wave length, the energy in no one of the lesser waves shall exceed 10 per cent of the energy in the principal wave.

The logarithmic decrement per complete oscillation must not exceed two-tenths.

A station used only for receiving does not require a station license. Operators of stations used only for receiving do not require operators' licenses, but must maintain secrecy in regard to messages.

Operators' licenses are divided into the following classes: Commercial extra first grade, commercial first grade, commercial second grade, commercial cargo grade, experiment and instruction grade, amateur first grade, and amateur second grade. In order to obtain an operator's license of any grade it is necessary to pass an examination showing certain qualifications, as set forth in the pamphlet mentioned above.

Both station licenses and operators' licenses are issued by the Bureau of Navigation of the Department of Commerce, Washington, D. C. The United States is divided into nine radio districts. Each district has a radio inspector, who has charge of the issuing of both station licenses and operators' licenses in his district. Application for either kind of license should be addressed to the radio inspector of the district in which the station is located, or, if this is not known, to the Bureau of Navigation, Department of Commerce, Washington, D. C.

The offices of the radio inspectors are located as follows :

- First District, Radio Inspector, Customhouse, Boston, Mass.
- Second District, Radio Inspector, Customhouse, New York, N. Y.
- Third District, Radio Inspector, Customhouse, Baltimore, Md.
- Fourth District, Radio Inspector, Customhouse, Baltimore, Md.
- Fifth District, Radio Inspector, Customhouse, New Orleans, La.
- Sixth District, Radio Inspector, Customhouse, San Francisco, Calif.
- Seventh District, Radio Inspector, 2301 L. C. Smith Building, Seattle, Wash.
- Eighth District, Radio Inspector, Federal Building, Detroit, Mich.
- Ninth District, Radio Inspector, Federal Building, Chicago, Ill.

It is probable that the radio laws will be revised in the immediate future. For authoritative information regarding the provisions of the current laws and regulations inquiry should be made of the Bureau of Navigation, Department of Commerce, Washington, D. C.

STATION CALL LETTERS.

All radio stations throughout the world under the jurisdiction of any countries adhering to the London International Radiotelegraph Convention of 1912 are assigned station calls consisting of three or four letters. Practically all countries of importance have adhered to this convention. There is no duplication of calls. Groups of call letters have been assigned to each of the countries under the authority of the convention. The calls assigned cover both land and ship stations.

The "International List of Radio Stations of the World" can be procured from the International Bureau of the Telegraphic Union, Berne, Switzerland. This list gives the call letters assigned to all stations, including those in the United States, and also gives the rates applying to and from stations. A copy of the International List should be in every land and ship station open to commercial business.

The "Yearbook of Wireless Telegraphy," published in London in May of each year, gives a list, with calls, of the radio stations of the world, and also contains in convenient form a compilation of the laws regulating radio communication in practically all countries.

United States Government and Commercial Calls.—The call letters assigned to the United States are all three and four letter combinations beginning with the letter *N* and all beginning with the letter *W*, and all combinations from *KDA* to *KZZ*, inclusive. All combinations beginning with the letter *N* are reserved for United States Government stations and have in most cases been assigned to stations of the United States Navy. The combinations from *WUA* to *WVZ* and from *WXA* to *WZZ* are reserved for stations of the United States Army. Calls assigned to the United States beginning with *K* and *W*, not assigned to Government stations, are reserved for commercial stations open to public and limited commercial service. In addition to calls consisting entirely of letters, certain Army and Navy stations use calls consisting in part of numbers.

United States Amateur Calls.—The station license issued for the operation of an amateur transmitting station in the United States designates a call which is to be used by that station at

all times. This call consists usually of a number followed by two letters, as *IAB*, but may consist of a number followed by three letters, as *IABC*. The number is the number of the radio district in which the station is located. Experiment stations have calls consisting of a number followed by two or three letters of which the first one is *X*, as *IXA*. Technical and training school stations have calls consisting of a number followed by two or three letters of which the first one is *Y*, as *IYA*. Special amateur stations have calls consisting of a number followed by two or three letters of which the first one is *Z*, as *IZA*. It is unlawful for any transmitting station at any time to sign any call except the call assigned in its station license. No station is allowed to transmit unless a station license has been issued. The radio regulations formerly provided that after an application for a station license had been filed, and pending the issue of the station license, a provisional call could be used and the station could transmit. This provision has been repealed.

The call letters assigned to the various radio stations of the United States are given in two pamphlets, Commercial, Government, and Special Radio Stations of the United States, and Amateur Radio Stations of the United States. These are sold by the Superintendent of Documents, Government Printing Office, Washington, D. C., at 15 cents each. A new edition of each of these pamphlets is compiled June 30 of each year. Changes during the year are noted in a monthly publication, the Radio Service Bulletin, which contains also information concerning changes in radio laws and regulations and traffic information. Subscriptions for the Radio Service Bulletin may be placed with the Superintendent of Documents at the rate of 25 cents per year for subscribers in the United States or its possessions, or in Canada, Cuba, or Mexico. To other countries the subscription price is 40 cents per year.

APPENDIX 7.

INTERNATIONAL OR CONTINENTAL CODE, AND CONVENTIONAL SIGNALS.

(TO BE USED FOR ALL GENERAL PUBLIC SERVICE RADIO
COMMUNICATION.)

1. A dash is equal to three dots.
2. The space between parts of the same letter is equal to one dot.
3. The space between two letters is equal to three dots.
4. The space between two words is equal to five dots.

<p> A — . — B — . . . C — . . — D — . . . E F — G — . — H I J — . — . — K — . — . — L M — . — . — N — . — . — O — . — . — P Q — . — . — R S T — . — . — U V W — . — . — X — Y — . — . — Z — . — . — </p> <hr/> <p> Ä (German) — . — . — Å or Å (Spanish-Scandinavian) — . — . — CH (German-Spanish) — . — . — É (French) </p>	<p> Ñ (Spanish) — . — . — Ö (German) — . — . — Ü (German) </p> <hr/> <p> 1 — . — . — 2 — . — . — 3 4 — . — . — 5 6 — . — . — 7 — . — . — 8 — . — . — 9 — . — . — 0 — . — . — </p> <hr/> <p> Period Comma Colon Interrogation Bar indicating fraction Double dash (paragraph) Distress call General inquiry call From (de) Invitation to transmit (go ahead) Wait Error Received (O. K.) End of each message (cross) Transmission finished (end of work) (conclusion of correspondence) </p>
--	--

ABBREVIATIONS USED IN RADIO COMMUNICATION.

Abbreviation.	Question.	Answer or notice.
QRA...	What ship or coast station is that?..	This is....
QRB...	What is your distance?.....	My distance is....
QRC...	What is your true bearing?.....	My true bearing is....degrees.
QRD...	Where are you bound for?.....	I am bound for....
QRF...	Where are you bound from?.....	I am bound from....
QRG...	What line do you belong to?.....	I belong to the....Line.
QRH...	What is your wavelength in meters?..	My wave length is....meters.
QRHH...	What tune shall I adjust for?.....	Adjust to receive on tune....
QRJ...	How many words have you to send?..	I have.... words to send.
QRK...	How do you receive me?.....	I am receiving well.
QRL...	Are you receiving badly? Shall I send 20?	I am receiving badly. Please send 20.
	for adjustment?	for adjustment.
QRLl..	Request permission to test....min- utes.	Permission to test granted.
QRM...	Are you being interfered with?.....	I am being interfered with.
QRN...	Are the atmospherics strong?.....	Atmospherics are very strong.
QRO...	Shall I increase power?.....	Increase power.
QRP...	Shall I decrease power?.....	Decrease power.
QRQ...	Shall I send faster?.....	Send faster.
QRS...	Shall I send slower?.....	Send slower.
QRT...	Shall I stop sending?.....	Stop sending.
QRU...	Use as question discontinued.....
QRV...	Are you ready?.....	I have nothing for you.
QRW...	Are you busy?.....	I am ready. All right now. I am busy (or: I am busy with....). Please do not interfere.
QRX...	Shall I stand by?.....	Stand by. I will call you when re- quired.
QRY...	When will be my turn?.....	Your turn will be No.
QRZ...	Are my signals weak?.....	Your signals are weak.
QSA...	Are my signals strong?.....	Your signals are strong.
QSB...	Is my tone bad?.....	The tone is bad.
QSC...	Is my spark bad?.....	The spark is bad.
QSD...	Is my spacing bad?.....	Your spacing is bad.
QSE...	What is your time?.....	My time is....
QSF...	Is transmission to be in alternate order or in series?	Transmission will be in alternate order.
QSG...	Transmission will be in series of 5 messages.
QSH...	Transmission will be in series of 10 messages.
QSI...
QSJ...	What rate shall I collect for.....?	Collect.....for.....
QSK...	Is the last radiogram canceled?.....	The last radiogram is canceled.
QSL...	Did you get my receipt?.....	Please acknowledge.
QSM...	What is your true course?.....	My true course is....degrees.
QSN...	Are you in communication with land?	I am not in communication with land.
QSO...	Are you in communication with any ship or station (or: with....)?	I am in communication with.... (through....).
QSP...	Shall I inform....that you are call- ing him?	Inform....that I am calling him.
QSQ...	Is....calling me?.....	You are being called by....
QSR...	Will you forward the radiogram?.....	I will forward the radiogram.
QSS...	Are my signals fading?.....	Your signals are fading.
QST...	Have you received the general call?..	General call to all stations.

ABBREVIATIONS USED IN RADIO COMMUNICATION—Continued.

Abbreviation.	Question.	Answer or notice.
QSU...	Please call me when you have finished (or at....o'clock).	Will call when I have finished.
QSV ¹ ..	Is public correspondence being handled?	Public correspondence is being handled. Please do not interfere.
QSW...	Shall I increase my spark frequency?.	Increase your spark frequency.
QSX...	Shall I decrease my spark frequency?	Decrease your spark frequency.
QSY...	Shall I send on a wave length of.... meters?	Let us change to the wave length of....meters.
QSZ.....	Send each word twice. I have difficulty in receiving you.
QTA.....	Repeat the last radiogram.
QTC.....	Have you anything to transmit?....	I have something to transmit.
QTE...	What is my true bearing?.....	Your true bearing is....degrees from....
QTF...	What is my position?.....	Your position is....latitude...longitude.

¹ Public correspondence is any radio work, official or private, handled on commercial wave lengths.

When an abbreviation is followed by a mark of interrogation, it refers to the question indicated for that abbreviation.

APPENDIX 8.

RADIO PUBLICATIONS.

PERIODICALS.

The field of radio communication is developing rapidly, and many important improvements are being constantly made. Persons who wish to keep informed regarding the most recent developments should arrange to see regularly one or more of the more important periodicals devoted to radio communication.

Persons interested in radio in a general way, or from the point of view of the amateur or experimenter, will find the following of particular interest:

Q. S. T. Published by the American Radio Relay League, Hartford, Conn.

Radio News, 235 Fulton Street, New York, N. Y.

Wireless Age, 326 Broadway, New York, N. Y.

Pacific Radio News, 151 Minna Street, San Francisco, Calif.

Wireless World, 12 Henrietta Street, London, England.

Persons who have had technical training in electricity and radio communication will be interested in the "Proceedings of the Institute of Radio Engineers," One hundred and fortieth Street and Convent Avenue, New York, N. Y., and the "Radio Review," 12 Henrietta Street, Strand, W. C. 2, London, England. An important French radio periodical is "Radioélectricité," 12 Place de Laborde, Paris, France.

The Bureau of Navigation of the Department of Commerce issues each month a periodical, the "Radio Service Bulletin," which contains information supplementing the lists of radio calls issued by the Bureau of Navigation, and changes in the Radio Laws and Regulations, and also contains other information of interest in connection with the radio service of the Government. Subscriptions to the Radio Service Bulletin, at the rate of 25 cents per year, may be placed with the Superintendent of Documents, Washington, D. C., for subscribers in the United States or its possessions, or Canada, Cuba, or Mexico. For other countries the subscription price is 40 cents a year.

GOVERNMENT PUBLICATIONS.

The Superintendent of Documents, Government Printing Office, Washington, D. C., will send without charge, on request, a copy of his "Price List No. 64," which lists Government publications of radio interest. All public documents are sold only by the Superintendent of Documents.

The Bureau of Standards issues a list of the publications of the Bureau of Standards which are of technical radio interest; a copy of this list may be secured by addressing the Radio Laboratory, Bureau of Standards, Washington, D. C. In general, the radio publications of the Bureau of Standards are of interest primarily to the specialist in radio science and engineering, who has had comprehensive technical training in the subject, rather than to the amateur. One of the most important radio publications of the Bureau of Standards is Circular 74, "Radio Instruments and Measurements," of which copies can be purchased from the Superintendent of Documents. Publications of the Bureau of Standards which are primarily of radio interest are listed on page 572.

The Bureau of Standards can not undertake to send individual notices of the appearance of new radio publications of the Bureau. Persons desiring to keep informed regarding new radio publications of the Bureau of Standards may subscribe to the "Radio Service Bulletin" (see p. 568), or other radio periodicals listed on page 568, in which such publications are promptly noted.

The Signal Corps of the Army has prepared a number of pamphlets for using in training the personnel of the Signal Corps. These pamphlets are listed on page 575 of this book. A number of publications of radio interest are included in this list.

Books.—In the past few years a considerable number of books have been published to meet the needs of the various classes of readers interested in radio. Below are listed some of the more important books which are particularly likely to be of interest to the elementary student. No effort has been made to list all of the radio books published. The divisions into classes according to difficulty is more or less arbitrary, and is simply intended as a general guide to help the person who has no familiarity with the literature.

BOOKS SUITABLE FOR THE BEGINNER.

E. E. Bucher. Practical Wireless Telegraphy. New York, 1918, Wireless Press, Inc.

E. E. Bucher. Wireless Experimenters' Manual. New York, 1920, Wireless Press, Inc.

Charles B. Hayward. How to Become a Wireless Operator. Chicago, 1918, American Technical Society.

Robison's Manual of Radio Telegraphy and Telephony. Annapolis, Md., 1920, United States Naval Institute.

The Admiralty Manual of Wireless Telegraphy. London, 1920, published by His Majesty's Stationery Office.

M. B. Sleeper. Design Data for Radio Transmitters and Receivers. New York, 1920, Norman W. Henley Publishing Co.

M. B. Sleeper. Radio Hook-Ups. New York, 1920, Norman W. Henley Publishing Co.

P. E. Edelman. Experimental Wireless Stations. New York, 1920, Norman W. Henley Publishing Co.

Ralph E. Batcher. Prepared Radio Measurements. New York, 1921, Wireless Press, Inc.

J. A. Fleming. Waves and Ripples in Water, Air, and Aether. Second edition, London, 1912, Society for Promoting Christian Knowledge.

J. A. Fleming. The Wonders of Wireless Telegraphy Explained in Simple Terms for the Nontechnical Reader. London, 1917, Society for Promoting Christian Knowledge.

A. C. Lescarbours. Radio for Everybody. New York, 1922, Scientific American Publishing Co.

ELEMENTARY TEXTS FOR STUDY.

G. D. Robinson. Modern Theory and Practice in Radio Communication. Annapolis, Md., 1920, United States Naval Institute.

E. W. Stone. Elements of Radio Telegraphy. New York, 1919, D. Van Nostrand Co.

J. C. Hawkhead and H. M. Dowsett. Handbook of Technical Instruction for Wireless Telegraphists. London, 1918, Wireless Press Limited.

A. N. Goldsmith. Radio Telephony. New York, 1918, Wireless Press Inc.

H. Lauer and H. L. Brown. Radio Engineering Principles. New York, 1920, McGraw Hill Book Co.

MORE ADVANCED TEXTS SUITABLE FOR REFERENCE.

H. M. Dowsett. *Wireless Telegraphy and Telephony*. London, 1920, Wireless Press Limited.

J. H. Morecroft. *Principles of Radio Communication*. New York, 1921, John Wiley & Sons.

Rupert Stanley. *Textbook of Wireless Telegraphy* (2 volumes). London, 1919, Longmans Green & Co.

U. S. Bureau of Standards. *Radio Instruments and Measurements*. (Bureau of Standards Circular No. 74.) Washington, D. C., 1918, Government Printing Office. (New edition in preparation.)

J. A. Fleming. *The Principles of Electric Wave Telegraphy*. Fourth Edition. London, 1919, Longmans Green & Co.

J. A. Fleming. *The Wireless Telegraphist's Pocket Book of Notes, Formulae, and Calculations*. London, 1915, Wireless Press Limited.

W. H. Eccles. *Wireless Telegraphy and Telephony*. London, 1918, Benn Brothers, Limited.

John Scott-Taggart. *Thermionic Tubes in Radio Telegraphy*. London, 1921, Wireless Press Limited.

B. Leggett. *Wireless Telegraphy, with Special Reference to the Quenched Spark System*. London, 1921, Chapman & Hall Limited.

L. B. Turner, *Wireless Telegraphy and Telephony*. Cambridge, England, 1921, Cambridge University Press.

RADIO PUBLICATIONS OF THE BUREAU OF STANDARDS.

The publications of the Bureau of Standards cover the various activities of the Bureau, which include investigations in many varied fields of investigation in electricity, light, sound, heat, chemistry, metallurgy, engineering materials, clay products, standards of weight and measure, and various other scientific and technical problems.

Circular 24 of the Bureau of Standards lists all of the publications of the Bureau on all subjects and gives a brief abstract of each. Price, 25 cents.

The publications of the Bureau of Standards, including Circular 24, can be secured by sending a money order for the correct amount to the Superintendent of Documents, Government Printing Office, Washington, D. C. Cash may be sent at sender's risk. Postage stamps and personal checks are not accepted.

An interesting survey of the various activities of the Bureau of Standards, including some radio work, is found in Miscellaneous Publication No. 46, "War Work of the Bureau of Standards," issued April 1, 1921. Price, 70 cents.

Many of the publications of the Bureau of Standards are listed in Price List 64, issued by the Superintendent of Documents, of which he will send a copy free on request.

In the following list there are given those publications of the Bureau of Standards which are of direct or collateral interest to the student of radio communication.

Scientific Paper No. 137. Mica Condensers as Standards of Capacity. H. L. Curtis. 1910. Price, 10 cents.

Scientific Paper No. 157. The Measurement of Electric Oscillations in the Receiving Antenna. L. W. Austin. 1910. Price, 5 cents.

Scientific Paper No. 158. Some Experiments with Coupled High-Frequency Circuits. L. W. Austin. 1911. Price, 5 cents.

Scientific Paper No. 159. Some Quantitative Experiments in Long Distance Radiotelegraphy. L. W. Austin. 1911. Price, 10 cents.

Scientific Paper No. 169. Formulas and Tables for the Calculation of Mutual and Self Inductance. Third edition, 1916. E. B. Rosa and F. W. Grover. Price, 20 cents. (See also Scientific Paper No. 320.)

Scientific Paper No. 189. Antenna Resistance. L. W. Austin. 1912. Price, 5 cents.

Scientific Paper No. 190. Energy Losses in Some Condensers Used in High-Frequency Circuits. L. W. Austin. 1912. Price, 5 cents.

Scientific Paper No. 206. High-Frequency Ammeters. J. H. Dellinger. 1913. Price, 10 cents.

Scientific Paper No. 226. Quantitative Experiments in Radiotelegraphic Transmission. L. W. Austin. 1914. Price, 5 cents.

Scientific Paper No. 234. Insulating Properties of Solid Dielectrics. H. L. Curtis. 1914. Price, 15 cents.

Scientific Paper No. 235. A Direct-Reading Instrument for Measuring the Logarithmic Decrement and Wave Length of Electromagnetic Waves. F. A. Kolster. 1914. Price, 10 cents.

Scientific Paper No. 252. Effective Resistance and Inductance of Iron and Bimetallic Wires. John M. Miller. 1915. Price, 20 cents.

Scientific Paper No. 257. Note on the Resistance of Radiotelegraphic Antennas. L. W. Austin. 1915. Price, 5 cents.

Scientific Paper No. 269. Effect of Imperfect Dielectrics in the Field of a Radiotelegraphic Antenna. John M. Miller. 1916. Price, 5 cents.

Scientific Paper No. 290. A Variable Self and Mutual Inductor. H. B. Brooks and F. C. Weaver. 1916. Price, 10 cents.

Scientific Paper No. 320. Additions to the Formulas for the Calculation of Mutual and Self Inductance. (Supplementing Scientific Paper No. 169.) F. W. Grover. 1918. Price, 10 cents.

Scientific Paper No. 326. Electrical Oscillations in Antennas and Inductance Coils. John M. Miller. 1918. Price, 5 cents.

Scientific Paper No. 341. Airplane Antenna Constants. J. M. Cork. 1919. Price, 5 cents.

Scientific Paper No. 351. Dependence of the Input Impedance of a Three-Electrode Vacuum Tube upon the Load in the Plate Circuit. John M. Miller. 1919. Price, 5 cents.

574 RADIO PUBLICATIONS OF THE BUREAU OF STANDARDS.

Scientific Paper No. 353. Variation in Direction of Propagation of Long Electromagnetic Waves. A. Hoyt Taylor. 1919. Price, 5 cents.

Scientific Paper No. 354. Principles of Radio Transmission and Reception with Antenna and Coil Aerials. J. H. Dellinger. 1919. Price, 10 cents.

Scientific Paper No. 355. The Determination of the Output Characteristics of Electron Tube Generators. Lewis M. Hull. 1919. Price, 5 cents.

Scientific Paper No. 381. An Electron Tube Transmitter of Completely Modulated Waves. Lewis M. Hull. 1920. Price, 5 cents.

Scientific Paper No. 423. Operation of the Modulator Tube in Radio Telephone Sets. E. S. Purington. 1921. Price, 10 cents.

Scientific Paper No. 427. Some Effects of the Distributed Capacity Between Inductance Coils and the Ground. G. Breit. 1921. Price, 5 cents.

Scientific Paper No. 428. The Radio Direction Finder and Its Application in Navigation. F. A. Kolster and F. W. Dunmore. 1921. Price, 15 cents.

Scientific Paper No. —. The Field Radiated from Two Horizontal Coils. G. Breit. 1922. Price, — cents.

Scientific Paper No. —. The High-Frequency Resistance of Inductance Coils. G. Breit. 1922. Price, — cents.

Circular 31. Copper Wire Tables. A complete compendium. 1914. Price, 20 cents. (Note: Persons who desire only a wire table for working purposes should secure a copy of Bureau of Standards Miscellaneous Publication No. 17, which is a card giving abbreviated copper wire tables in English units on one side of the card and in metric units on the other side: price, 5 cents.)

Circular 36. The Testing and Properties of Electric Condensers. 1912. Price, 5 cents.

Circular 60. Electric Units and Standards. 1916. Price, 15 cents.

Circular 74. Radio Instruments and Measurements. 1918. 341 pages. A comprehensive treatise on radio measurements. Price, 60 cents. It is expected that a revised edition of Circular 74 will be issued during 1922.

Circular 112. Telephone Service. 214 pages. 1921. Price, 65 cents.

SIGNAL CORPS PAMPHLETS.

The following pamphlets have been prepared in the Office of the Chief Signal Officer, Training Section, for use in the training of the personnel of the Signal Corps. These publications can, however, be secured by the public by purchase from the Superintendent of Documents, Government Printing Office, Washington, D. C., at the price stated. Remittance should be made by money order. Cash may be sent at the sender's risk. Postage stamps and uncertified checks are not accepted.

Other pamphlets are in preparation.

RADIO COMMUNICATION PAMPHLETS.

(Formerly designated Radio Pamphlets.)

No.

1. Elementary Principles of Radio Telegraphy and Telephony (79 pages). War Department Document No. 1064. Price, 10 cents.
2. Antenna Systems (19 pages). Price, 10 cents.
3. Radio Receiving Sets (SCR-54 and SCR-54-A) and Vacuum Tube Detector Equipment (Type DT-3-A). Price, 10 cents.
4. Airplane Radio Telegraph Transmitting Sets (Types SCR-65 and 65.A). Price, 10 cents.
9. Amplifiers and Heterodynes (W. D. D. 1092). Price, 10 cents.
10. Ground Telegraphy or T. P. S. (Types SCR-71; SCR-72; SCR-72-B). Price, 10 cents.
11. Radio Telegraph Transmitting Sets (SCR-74; SCR-74-A). Price, 10 cents.
13. Airplane Radio Telegraph Transmitting Set (Type SCR-73). Price, 10 cents.
14. Radio Telegraph Transmitting Set (Type SCR-69). Price, 10 cents.
17. Sets, U. W. Radio Telegraph (Types SCR-79-A and SCR-99) (W. D. D. No. 1084). Price, 5 cents.
20. Airplane Radio Telephone Sets (Types SCR-68; SCR-68-A; SCR-114; SCR-116; SCR-59; SCR-59-A; SCR-75; SCR-115), 58 pages. Price, 10 cents.

No.

22. Ground Radio Telephone Sets (Types SCR-67; SCR-67-A)
Price, 10 cents.
23. U. W. Airplane Radio Telegraph Set (Type SCR-80)
Price, 10 cents.
24. Tank Radio Telegraph Set (Type SCR-78-A). Price, 10
cents.
25. Set, Radio Telegraph (Type SCR-105) (W. D. D. No. 1077)
Price, 10 cents.
26. Sets, U. W. Radio Telegraph (Types SCR-127 and SCR-
130) (W. D. D. No. 1056). Price, 10 cents.
28. Wavemeters and Decremeters (W. D. D. No. 1094). Price
10 cents.
30. The Radio Mechanic and the Airplane. Price, 10 cents.
40. The Principles Underlying Radio Communication (edition
of May, 1921) (W. D. D. 1069). Price, \$1.00, Buckram
binding.

WIRE COMMUNICATION PAMPHLETS.

(Formerly Designated Electrical Engineering Pamphlets.)

1. The Buzzerphone (Type EE-1). Price, 10 cents.
2. Monocord Switchboards of Units (Types EE-2 and EE-2-A)
and Monocord Switchboard Operator Set (Type EE-64)
(W. D. D. No. 1081). Price, 5 cents.
3. Field Telephones (Types EE-3; EE-4; EE-5). Price, 10
cents.
6. Trench Line Construction. Price, 10 cents.
7. Signal Corps Universal Test Set (Type EE-65) (W. D. D.
No. 1020). Price, 10 cents.
10. Wire Axis Installation and Maintenance Within the Divi-
sion (W. D. D. No. 1068). Price, 10 cents.
11. Elements of the Automatic Telephone System. Price, 10
cents.

TRAINING PAMPHLETS.

1. Elementary Electricity. 52 pages. (W. D. D. No. 1055).
Price, 15 cents.
4. Visual Signaling. 48 pages. Price, 10 cents.
5. The Homing Pigeon, Care and Training (W. D. D. No.
1000). Price, 10 cents.
7. Primary Batteries. Price, 10 cents.
8. Storage Batteries. 56 pages. Price, 10 cents.

FIELD PAMPHLETS.

No.

1. Directions for Using the 24-CM. Signal Lamp (Type EE-7).
Price, 10 cents.
2. Directions for Using the 14-CM. Signal Lamp (Type EE-6).
Price, 10 cents.

APPENDIX 9.

SAFETY PRECAUTIONS.

The ordinary precautions required for the safe operation of any electrical equipment should be observed in every radio station. All high-voltage wiring should be carefully insulated and kept as far as possible from other wiring and so placed as to minimize the possibility that the operator may come in contact with it, and suitable danger tags should be displayed.

Insurance companies make certain requirements regarding electrical installations in any buildings on which they carry risks. Information regarding such requirements may be secured from the National Board of Fire Underwriters, New York, or from local insurance agents. These requirements are summarized in a small book, the National Electrical Code, which contains a section covering special requirements for radio installations.

Certain requirements are also made by State, city, and other local governments, which vary considerably in different localities.

The Bureau of Standards has for some time been engaged in studies of the precautions which should be observed for the safe operation of electrical equipment of all kinds. The results of these investigations are summarized in a publication, "National Electric Safety Code," Bureau of Standards Handbook No. 3. Copies may be purchased for 40 cents from the Superintendent of Documents, Government Printing Office, Washington, D. C.

Every radio station should be provided with a lightning switch on the outside of the building, consisting of a single-pole double-throw switch, by means of which the antenna should be connected directly to the ground at all times when the station is not actually in use. The ground connection should be carefully made to allow a path of low resistance to ground for the lightning. The nature of construction required for the ground connection will vary with the nature of the soil. The ground connection of the lightning switch should be at a considerable distance, 30 feet or more if possible, from the ground connection of the transmitting and receiving apparatus.

Kick-back prevention.—If no precautions are taken, trouble will often be encountered at transmitting stations due to radio-frequency current finding its way either directly or inductively back to the source of power supply, or to other adjacent circuits. Serious difficulties may sometimes arise from this cause. Transformers and generators may be burned out, or persons may be injured by shock.

Choke coils of suitable inductance may be inserted in the leads from the power supply to the transmitting apparatus, which will prevent the flow of radio-frequency current, but permit the flow of audio-frequency current. The use of choke coils in the transformer secondary leads of spark transmitting sets is discussed on page 381.

By-pass condensers of suitable capacity may be connected across the leads from the power supply to the transmitting apparatus. These condensers will offer a path of low impedance to radio-frequency current. The use of by-pass condensers in electron tube generating sets has been discussed on page 496. Aluminum electrolytic cells may be connected across the leads, as described on page 497.

The antenna of either a transmitting or receiving station should be so erected as to be well removed from electric light wires, particularly those of high voltage. The antenna may be blown against the electric light wires if they are close together, and the high voltage of commercial frequency brought into the station apparatus.

The antenna of a transmitting station should be well removed from overhead wires of any kind, electric light, telegraph or telephone, or even guy wires. Antenna wires should not be run directly over or under, or parallel to, electric light or other wires. Otherwise serious inductive disturbances may be set up in the electric light or telephone wires, with unfortunate results in near-by buildings and at central offices.

The following precautions have also been found desirable in practice. They apply particularly to the conditions met at small transmitting stations. The safety precautions to be observed at high-power stations are important features in the station design, and require special consideration.

In a transmitting station, wires carrying radio-frequency current should at no time be permitted to come within 3 feet of the

wires carrying the supply current, or within 3 feet of telephone wires, door bell wires, or other signal wires. This means that the transformer of a spark set should be placed at least 3 feet from the condenser and helix (oscillation transformer). It is not necessary that the leads from the transformer secondary to the condenser of a spark set be short, since they do not affect the tuning. Wires carrying radio-frequency currents should not be run parallel for any appreciable distance to electric light or telephone or signal wires even at a distance considerably more than 3 feet. It is desirable that the supply circuit be run in grounded metal conduit. If these precautions are observed, the electric light or power line supplying a transmitting set, and adjacent telephone lines, may be expected to have very little trouble from radio-frequency inductive disturbances.

In a transmitting station in which a rotary gap is used, it is important that the gap be mounted true and correctly in line, that the teeth be perfectly spaced, and that a short gap clearance be used. Failure to observe these precautions may greatly increase the inductive disturbances from a rotary gap set.

The inductive disturbances which have been mentioned are frequent sources of difficulties between operators of radio stations and companies supplying electric light and power. They also necessarily decrease the power available for radiation. With proper attention these difficulties may be largely eliminated. Another source of difficulty is the flickering on electric light lines supplying radio transmitting sets, due to the varying load and consequent varying voltage supplied to incandescent lights on the same line. During operation the transmitting apparatus may be connected to the supply line for a few minutes and then disconnected for a few minutes; the varying current in the supply line will affect every light connected on the same circuit. There is also a keying flicker; the opening and closing of the signaling key will affect the current in the supply line and cause a rapid flicker which is decidedly noticeable. A remedy for the flicker difficulties is to install a separate transformer to supply the radio transmitting set and to connect no lights to this transformer.

An interesting discussion of precautions to be observed at spark transmitting stations may be found in Q. S. T., volume 5, page 7, November, 1921.

INDEX.

	Page.
Abbreviations, code.....	566
units.....	548, 549
Abscissa.....	49
Absorber tube, modulation.....	519
Absorption, current.....	44
dielectric.....	93
method of modulation.....	516, 519
method, signaling, arcs.....	416
transmission phenomena.....	294
Accumulators.....	60, 67
Adjustment of arc converter.....	411
of electron tube generator.....	495
of quenched gap.....	360
of transmitting sets.....	376
Advance resistance, alloy.....	55
Advantages of arc converters.....	400
of heterodyne reception.....	504
of high-frequency alternator.....	399
of undamped waves.....	396
Aerial, see antenna.	
Ageing of transformer iron.....	183
Air, dielectric constant.....	92
dielectric strength.....	390
sparking voltage.....	390
Air-core transformer.....	129
Aircraft antenna.....	311
Airplane generator.....	196
Alcohol, use in arc chamber.....	413
use in rotary gap.....	363
Alexanderson alternator.....	204, 397
magnetic amplifier.....	517
Alkaline electrolyte, storage cells.....	69
All stations copy, code signal.....	566
Alloys, as conducting materials.....	41
low-melting.....	434
Alphabet, International Code.....	565
Alternating current.....	25, 116
advantages.....	128
average value.....	118
effective value.....	118
filament supply.....	496
generators.....	153
motors.....	220
plate supply.....	498

	Page.
Alternator.....	153
Alexanderson	204
Bethenod.....	207
frequency	170
Goldschmidt	207
high-frequency	397
high-frequency, modulation	517
inductor.....	165
Latour	207
polyphase	166
radio-frequency.....	204
Aluminum, conductor.....	40
electrolytic cell.....	497, 579
wire	325
Amalgamation, battery electrode.....	62
Amateur antenna.....	318
call letters.....	563
publications.....	568
station license	561
American wire gauge.....	41, 554
Ammeter.....	22, 32
alternating-current	137
current-square meter.....	137
direct-current	140
hot-wire.....	137
shunt.....	141
thermal	136
thermocouple.....	136
Ampere	32
definition.....	549
Ampere-hour.....	33, 550
capacity of battery.....	60
Ampere-turns	104
Amplification, audio-frequency	484
coefficient.....	460, 482
coefficient, power.....	462
radio-frequency.....	481
radio-frequency, short wave.....	506
regenerative	487
regenerative, sensitivity.....	449
voltage.....	484
Amplifier, electron tube.....	479
magnetic	399, 517
transformers.....	135
use in radiotelephone microphone circuit.....	514
use with coil antenna.....	330
Amplifying action, electron tube.....	479
modulator tube.....	524
Amplitude of wave.....	284

	Page.
Analysis of modulated wave.....	508
Angle of wave front.....	328
Annapolis station.....	396, 401
Anode, arc converter.....	408
battery.....	61
Antenna.....	304
action in receiving.....	298
airplane.....	311
cage.....	307
capacity, measurement.....	394
capacity of.....	311
coil.....	304, 336
condenser type.....	304
conductors.....	324
constants, measurement.....	543
construction.....	322
counterpoise.....	310
current distribution in.....	308
current, measurement.....	448
directional effect.....	319
directive.....	319
effective height.....	301
fan.....	306
field radiated from.....	297
fundamental wave length.....	316
ground.....	327
harp.....	306
horizontal.....	306
inductance, measurement.....	392
inductance of.....	313
insulators.....	322
losses.....	314
multiple-tuned.....	315
plain, connection.....	369, 374
resistance of.....	313
safety precautions.....	579
submarine.....	328, 338
supports.....	322
switch.....	324, 578
towers.....	322
trailing wire.....	311
transmission formulas.....	299
types.....	304
umbrella.....	303
underground.....	328, 338
underwater.....	328, 338
vertical wire.....	320
voltage distribution.....	308
wave length, measurement.....	318

	Page.
Antenna wire	324
Antimony, detector	437
thermocouple	55
Aperiodic circuit	257
Apparatus, for damped wave transmission	353
receiving	419
symbols	553
Arc circuits	413
converter	400
Arcing, of spark gaps	358
Argon, tungar rectifier	544
Armature core	157
dynamo	156
impedance	177
reaction	177
winding	156
Armstrong, beat method with radio frequencies	506
super-heterodyne	506
Arrangement of cells	81
Atmosphere, transmission phenomena	288
Atmospherics	290
Atoms	33
electrons	450
Attenuation, telephony	532
Audibility measurement	449
meters	449
Audio-frequency	191
alternator	192
amplification	484
amplifier	481
tuning	382
Audions. <i>See</i> Electron tubes.	
Autodyne reception	503
Automatic switchboard, telephone	146
telegraph apparatus	145
transmission	509
Auto-transformer	134
Auxiliary battery, crystal detector	437
Average value, alternating current	118
Avoirdupois system	548
B battery	456
Back shunt method, signaling, arc	417
Back wave, arc converter	415
Bakelite	42
molded, dielectric constant	92
Balancing condenser, direction finder	343
Band, wave length	515
Band-frequency, filter	534

	Page.
Bar magnet.....	100
Base, Napierian.....	552
Basket-wound inductance coll.....	445
Batteries.....	53, 59
carbon cylinder.....	66
caustic soda.....	66
closed circuit.....	66
dry.....	64, 538
internal resistance.....	63
Leclanche.....	66
parallel connection.....	79
primary.....	63
series connection.....	79
storage.....	67, 538
Battery, charging, motor generators.....	223
Beacon, radio.....	349
Bearing, code signal.....	567
Beat frequency, line radio.....	532, 536
Beat reception.....	501, 546
zero.....	514
Beats.....	432, 501
coupled circuits.....	276
Beeswax, dielectric constant.....	92
Bellini-Tosi direction finder.....	345
Bell-ringing transformer.....	66, 134
Bethenod alternator.....	207
Biasing potential.....	486
Bipolar dynamo.....	156
Blow-out, magnetic, arc converter.....	411
Blub-blub.....	512
Blue-glow discharge, electron tubes.....	454, 475
Boat, producing waves.....	281, 284
Boats, surf, use of coil antenna on.....	351
Body leakage.....	44
Books, radio.....	569
Booster battery, crystal detector.....	439
Borax, aluminum cell.....	497
Bordeaux station.....	401
Bornite detector.....	434
Bridge, mechanical resonance.....	240
Bridge, Wheatstone.....	86, 538
Broad wave.....	377
Brown & Sharpe wire gauge.....	41, 555
Brown telephone receivers.....	441
Brush discharge.....	383
Brushes.....	162
Bulletin, Radio Service.....	564, 568
Bureau of Navigation.....	562
Bureau of Standards.....	547, 572

	Page
Buzzer modulation.....	529
By-pass condenser.....	477, 525
action of telephone receiver.....	443
electron tube generator.....	496
safety devices.....	496, 579
C battery.....	474, 486
Cadmium cell.....	56
Cage antenna.....	307
Calibration, direction finder.....	348
wave length.....	541
Call letters, station.....	563
Calories.....	35, 550
Capacitance, <i>See</i> Capacity.	
Capacitive coupling.....	268, 528
electron tube generators.....	492
Capacitive reactance.....	235
Capacitively-coupled amplifier.....	481
receiving set.....	428
Capacity, antenna.....	311
antenna, measurement.....	543
effects.....	250, 266
heterodyne reception.....	504
in coil antenna.....	335
electric.....	89
geometric.....	94
measurement.....	394, 540
of batteries.....	60
of coil antenna.....	342
of condensers.....	384
of inductance coils.....	250, 446
of storage battery.....	67
parallel wires.....	96, 312
reactance.....	233
single wire.....	312
sphere.....	96
square plates.....	96
unit.....	91, 549
variation with dielectric.....	91
wave length table.....	557
wires and cables.....	96
Carbide, silicon, detector.....	434
Carbon-cylinder battery.....	66
Carbon electrode, arc converter.....	408
Carbon rheostat.....	40
Carborundum detector.....	434
use of booster battery.....	439
Care of storage cells.....	72
Carrier frequency.....	508

	Page.
Carrier supply at receiving station, radiotelephony-----	514
suppression-----	514, 535
telephony-----	530
Cascade amplification-----	480
Castor oil, dielectric constant-----	92
Catalina Island radiotelephone station-----	516
Cathode, arc converter-----	408
battery-----	61
Cat's fur, frictional electricity-----	52
Cat-whisker contact, crystal detector-----	434
Caustic soda cells-----	66
Cells-----	59
Cells, see also batteries.	
Cellular inductance coil-----	445
Celluloid, dielectric constant-----	92
Centimeter, unit of length-----	548
of capacity-----	550
of inductance-----	111, 550
Chalcopyrite detector-----	434
Chamber, arc-----	404, 408
Chamfering of poles-----	159
Characteristic, antenna-----	311
curve, crystal detector-----	437
curves, electron tubes-----	459, 544
Characteristics, of coil antennas-----	333
of dynamo terminal voltage-----	186
two-electrode tubes-----	454
Charge, electric, unit-----	549
of electron-----	451
Charging of storage cells-----	72
Chemical effect, electric current-----	29, 537
Choke coils-----	355, 381, 524, 579
Chopper, compared with heterodyne reception-----	504
modulation-----	529
use in arc circuit-----	415
use in reception-----	430
Circuit, aperiodic-----	257
electric-----	76
magnetic, of dynamo-----	161
phantom-----	531
Circuits, coupled-----	267
generating, electron tubes-----	491
natural frequency-----	558
radio-----	231
radiotelephone-----	522
transmitting-----	368
Close coupling-----	268, 378
Closed-circuit cells-----	66
Closed-core transformer-----	129

	Page
Coarse tuning-----	425
Coast Guard boats, use of coil antenna-----	351
Coated filaments, electron tubes-----	469
Code, Continental-----	145, 563
International-----	145, 565
Morse-----	145
National Electrical-----	578
National Electric Safety-----	578
visual signaling-----	20
Coefficient, amplification-----	460, 482
of coupling-----	269, 542
Coil antenna-----	304, 330
directional effect-----	339
transmission formula-----	300
Coll, inductance-----	109, 386, 443
inductance, capacity of-----	250
Tesla-----	134
transmitters-----	351
Coil-wound armature-----	157
Collector rings-----	162
Collision, ionization by-----	453
Commercial calls-----	563
frequency-----	191
operator's license-----	562
station license-----	561
Communication, methods-----	19
radio-----	20
Commutation-----	179
Commutator-----	179
Commutator ripple-----	496, 528
Compass, magnetic-----	101
radio-----	340
Compensation, direction finders-----	343
wave, arcs-----	415
Compensator, induction motors-----	222
Complete modulation-----	499, 510
Complete modulation, line radio-----	535
Composite operation, telegraphy-----	150, 531
telephony-----	150, 531
Compound excitation-----	186
Compound-wound generators-----	186
motors-----	219
Concentrated winding-----	159
Condenser-----	90
antenna-----	305
balancing-----	343
by-pass-----	496, 579
capacity, measurement-----	540
charging of-----	126

	Page.
Condenser construction -----	95
design -----	384
dielectric loss in -----	127
effect of, in electric circuit -----	25
effect of, in radio circuit -----	25, 355
energy losses -----	93, 239
formula for capacity of -----	96
geometric capacity of -----	94
in grid lead -----	475
perfect -----	127
reactance of -----	126
receiving -----	447
rotating plate -----	431
transmitter -----	518
transmitting -----	356
variable -----	447
Condensers in parallel -----	99
in series -----	99
Conductance -----	34
unit of -----	37
Conducting materials -----	34, 40
Conduction, electron theory of -----	33
Conductivity -----	37
unilateral, contact detector -----	437
Conductors -----	40
Conservation of energy -----	46, 464
Constant potential charge method for storage cells -----	73
Constant-speed motors -----	217
Constants, antenna, measurement -----	543
electron tube -----	460, 462, 482
Construction of antennas -----	322
of arc converters -----	408
of three-electrode tube -----	457
Contact detectors -----	433
Continental code -----	145, 565
Continuous waves -----	285, 396
from electron tube generator -----	495
trains of -----	285
Control, remote -----	398
Controls, wave-length, radiotelephone sets -----	526
Convention, International Radio -----	561
Conventional signals -----	565
Conversion table, metric -----	548
Converter, arc -----	400
rotary -----	224
Cooling of anode, arc converter -----	412
of transformers -----	134
Coordinates -----	49
Copper, conductor -----	40

	Page.
Copper electrode arc converter.....	408
losses, dynamo.....	172
losses, transformers.....	132
wire, antennas.....	325
wire, resistance.....	554
wire tables.....	554
Copper-clad wire.....	325, 535
Core losses, dynamo.....	173
transformer.....	133
Cottonseed oil, dielectric constant.....	92
Coulomb.....	33
definition.....	549
Counter-electromotive force.....	212
Counterpoise.....	305, 309
construction.....	326
on aircraft.....	311
Coupled circuits.....	112, 267
damping.....	275
transmitting.....	373
Coupler, loose.....	444
Coupling, adjustment of transmitting sets.....	376
capacitive.....	268
capacitive, receiving set.....	428
close.....	268, 378
coefficient of.....	269
direct.....	267
inductive.....	267, 541
loose.....	268
relation to resonance or tuning.....	376
requirement for quenched gap.....	377
resistance.....	267
Crest of wave.....	282
Critical coupling of quenched gap set.....	375
Cross-coil direction finder.....	345
Cross-talk, line radio.....	535
telephone.....	293
telephone lines.....	113
Crystal detector.....	433, 544
sensitivity.....	449
use with electron tube amplifier.....	488
Current, absorption.....	44
alternating.....	116
chemical effect of.....	29
dielectric.....	44
direct.....	24
direction of.....	30
displacement.....	44
distribution in antenna.....	308
distribution in cross section of conductor.....	264

	Page.
Current, electric, effects of	29
electric, flow of	22
electric, kinds	25
heat effect of	29
light effect of	29
magnetic effect of	31
magnetizing, transformer	130
measurement of	391
measuring instruments	136
through electron tubes	451
unit	549
Current-square meters	138
Curve plotting	49
Curve, sine	116, 155
Curves, resonance	241, 540
Cycle	117, 155
Damped oscillations	255
Damped-wave transmission, apparatus for	353
Damped waves, circuits for reception of	422
Damping	251
coupled circuits	275
of free oscillations	257
telephone current	532
transmitting sets	378
Dash	144
Daylight effect, transmission	288
Decrement	258
effect on tuning	260
logarithmic	258
measurement	394, 542
modulated continuous waves	515
of coupled circuits	275
of quenched gap circuits	379
radio law	561
relation to tuning	260
transmitting sets	378
zero, continuous waves	514
De Forest tube	472
Delonization, arc converter	404, 411
Delta connection	169
Depolarizer, batteries	63
Design, transmitting sets	384
Detector	422
action, electron tube	472, 545
contact	433
crystal	433, 544
sensitivity	449
53904°—22—38	

	Page.
Detuning, method of signaling.....	517, 518
Diaphragm, microphone.....	148
telephone receiver.....	148
Dielectric absorption.....	93
constant.....	92
current.....	89, 90
losses, antenna.....	314
materials.....	42
power loss.....	43, 93, 239
properties.....	91
strain.....	90
strength, air.....	390
strength, insulating materials.....	42
Difficulties in transmission.....	289
Diffraction, radio waves.....	288
Diode. <i>See</i> Electron tube.	
Direct-coupled transmitting set.....	373
Direct coupling.....	267
Direct current.....	24
Direct-current generators.....	179
motors.....	210
Directional antenna.....	319
Directional variations of radio waves.....	347
Direction of current.....	30
Direction finders. (<i>See also</i> Coil antennas).....	339
Discharger. <i>See</i> Spark gap.	
Discontinuous wave trains.....	285
Displacement current.....	26, 44, 89
Displacement, electromagnetic waves.....	287
Distant control.....	398
Distortion, arc converter.....	411
line radio.....	533
modulation.....	518
of wave front.....	347
telephony.....	150
Distress signals, decrement.....	370
Disturbances, inductive.....	578
Distributed capacity of inductance coil.....	250, 446
Distributed winding.....	159
Divided circuits.....	82
Divider, voltage.....	56
Documents, Superintendent of.....	561, 564, 569, 572, 575
Dot.....	144
Dot-and-dash modulation.....	508
Double-coil direction finder.....	343
Double-current generator.....	227
Double-hump resonance curve.....	270
Driver, wavemeter.....	540
Drum winding.....	181

	Page.
Dry batteries.....	64
Duddell arc.....	405
Duo-lateral inductance coll.....	445
Duplex communication.....	532
radiotelephony.....	527
Dynamo-electric machinery.....	152
Dynamotors.....	226, 539
Dynamos.....	152
Earth connections.....	310, 326, 578
Earth's magnetic field.....	103
Eddy current losses, dynamo.....	173
transformer.....	132
Edgewise-wound helix.....	387
Edison effect.....	451
Edison storage battery.....	69
Edison-Swan electron tube.....	472
Effective height of antenna.....	301
inductance.....	416
magnetic modulator.....	517
of transformer.....	131
resistance.....	265
resistance of antenna.....	314
value, alternating current.....	118
Efficiency, modulation.....	521
of arc converter.....	409
of dynamos.....	175
of electron tube generator.....	495
transmitting sets.....	383
Elastic medium, wave motion.....	286
Electric circuit.....	76
Electric current, effects of.....	29
measurement of.....	136
unit of.....	32
Electric displacement current.....	89
Electric field intensity.....	97, 287
variation of, near antenna.....	299
Electric oscillations.....	253
potential.....	47
railroads, line radio communication.....	535
units.....	549
waves.....	287, 292
waves, velocity of.....	283, 287
Electro-chemical series.....	53
Electrode, arc converter.....	412
battery.....	61
electron tube.....	452, 456
Electrolyte for storage batteries.....	75
Electrolytes.....	53, 61

	Page.
Electrolytic cell, aluminum.....	497
Electrolytic effect of electric current.....	29
Electromagnet.....	101, 104
Electromagnetic waves.....	283, 287, 292
velocity of.....	19, 283, 287
Electromotive force.....	23, 44
caustic soda battery.....	66
gravity battery.....	66
dry battery.....	65
Leclanche battery.....	66
sources of.....	51
storage battery.....	70
Electron emission.....	451
flow.....	451
Electrons.....	33, 450
Electron tubes.....	450
Electron tube, amplifying action.....	479
beat reception.....	501, 546
blue glow discharge in.....	454, 475
characteristic curve.....	544
constants of.....	460, 462, 482
detector action.....	472
effect of grid.....	456
generating action.....	489
generator, decrement.....	542
ionization in.....	452
modulating action.....	519
plate current.....	452
practical forms.....	469
source for radio measurements.....	542
with crystal detector.....	489
voice modulation by.....	519
Electrose insulators.....	322
Electrostatic charges.....	52
Electrostatic coupling.....	428
Elimination of interference.....	289
Elimination of strays.....	290
Emission of electrons.....	452, 455
Enameled copper wire, table.....	555
Enameled wire.....	325
Energy of electric current.....	26
Energy, conservation of.....	46
electrostatic.....	90
in radio circuits.....	251, 257
kinetic.....	46
of motion.....	46
potential.....	44
relations in inductive circuits.....	114
stored in condenser.....	98

	Page.
Energy, transformation of-----	46
transmission by wave motion-----	284
transmission of-----	26
unit-----	47, 549
Envelope, modulating action-----	512
Equal heterodyne-----	501
Equivalent decrement, modulated continuous waves-----	515
Examinations, operator, license-----	562
Excitation, alternators-----	162
direct-current generators-----	184
impulse-----	278
loss, dynamos-----	172
Exciter, dynamo-----	162
wavemeter-----	540
Expansion-type ammeter-----	137
Experiments, laboratory-----	537
Experiment station, license-----	561
Explosive mixture, arc converter-----	404
Extinction voltage, arc converter-----	406, 412
Fading, code signal-----	566
transmission phenomena-----	291
Falling characteristic of arc-----	402
Fan antenna-----	306
Fan-driven generator for airplane-----	196
Farad-----	91
definition-----	549
Feed-back action, electron tubes-----	490
Ferromagnetic control-----	399, 517
Ferron detector-----	434
Fiber, vulcanized, dielectric constant-----	92
Field, electric, intensity-----	97
excitation of alternator-----	162
induction-----	292
magnet-----	156
magnetic, arc converter-----	411
measurements-----	389
pamphlets, Signal Corps-----	575
radiation-----	292
rheostat-----	179
Filament, electron tube-----	451
Filament supply, alternating current-----	496
Filter-----	247
band-frequency-----	534
radiotelephone set-----	528
Fine tuning-----	425
Fine-wire contact, crystal detector-----	434
Fire underwriters-----	578
Flags, communication by-----	20

	Page.
Flat-compounded generator	188
Flat-top antenna, capacity of	312
Fleming valve	425
Flicker, keying	580
Flow of electrons	451
Fluctuations of received signal	291
Flux, magnetic	103
density, magnetic, unit	103
linkages	108
Fog signaling	321
Forced oscillations	272
Formula, d. c. generator	189
Formula for capacity of condenser	384
Formulas, transmission	299
Frame antennas	331
Free oscillations	251
oscillations, coupled circuits	274
Freezing of storage batteries	74
French high-frequency alternator	207
tubes	471
Frequency, alternating currents	117, 155
alternator, equation	170
audio	191
carrier	508
commercial	191
effect on attenuation	532
high, necessity for, in radio communication	293
natural	257
natural, table	557
radio	191
resonance	237
side	509
spark	355
wave motion	282
Frictional electricity	52
Fundamental frequencies of antennas	319
Fundamental wave length, antenna, measurement	543
arc converters	401
coil antenna	333
of antenna	316
Fuse in plate lead, tube generator	496
Galena detector	434
Galvanometer, moving coil	140
Gap, quenched	278, 358
rotary	361, 580
spark	354
Gaseous conductors	404
Gas-pipe ground	327
Gas tubes	454

	Page.
Gas, use in arc chamber-----	413
Gauge, wire-----	41, 554
Gauss, unit of magnetic flux-----	107
General call, code signal-----	566
General Electric electron tube-----	469, 472
Generating action of electron tube-----	489
Generator tube-----	545
Generator tube, modulation-----	546
Generators, alternating-current-----	153
direct-current-----	179
dynamos-----	152
Geometric capacity-----	94
German silver, conductor-----	41
Glass, dielectric constant-----	92
Glass-plate condenser-----	385
Goldschmidt alternator-----	207
Goniometer, radio-----	340
Government calls-----	563
Government Printing Office-----	561, 564, 569, 572, 575
Government radio publications-----	569, 572, 575
Gram-----	547
Gram calorie-----	550
Graphical methods of measuring wave length of antenna-----	318
Gravitational potential-----	45
Gravity cell-----	66, 145
Grid battery-----	474, 486
characteristics, electron tube-----	464
condenser-----	475
current-----	459
electron tube-----	456
leak-----	476
modulation, radio telephony-----	519
potential, adjustment-----	486
voltage-----	458
Grinders, strays-----	290
Ground, action of-----	309
antennas-----	327
multiple-----	316
return, telegraph line-----	145
Grounds, construction-----	326, 578
Guided-wave telephony-----	530
Guy wires-----	314, 322
Hard rubber, dielectric constant-----	92
Hard tubes-----	454
Harmonics, arc converters-----	401
in antennas-----	319
interfering-----	531
Harp antenna-----	306
Heat losses-----	87

	Page.
Heat waves	282, 283
Heating effect of electric current	29, 537
Heating of plates, electron tubes	469
Heaviside layer	288
Hectoliter	548
Height, effective, of antenna	301
Helix, inductance of	386
Helix oscillation transformer	371
Henry, definition	549
unit of inductance	111
Hertzian oscillator	295
Heterodyne action	509
reception	432, 501, 546
reception, linear law	505
reception of modulated wave	500, 505
High-frequency alternator	205, 397
conductor	415
necessity for, in radio communication	293
resistance	263, 542, 556
telephony	530
transformer	272
<i>See also</i> Radio-frequency.	
High-speed telegraphy	145
transmission	400, 509
High voltage, use in power transmission	129
Hinged-coil oscillation transformer	373
Honey-comb inductance coil	445
Homodyne method, modulation	535
Homodyne reception	505
Horn tube	471
Horsepower	48, 550
Horse-shoe magnet	101
Hot-wire ammeters	137
Howling of amplifiers	485
Humidity, effect on insulating materials	42
Hump, double	270
double, resonance curve	270
Hydraulic pressure	47
Hydrogen atom	451
Hydrogen, evolution in batteries	62
use in arc chamber	413
use in rotary gap	363
Hydrometer	70
Hysteresis losses, dynamo	173
transformer	133
Ignition key, signaling by arcs	416
method, signaling arcs	416
voltage, arc converters	403, 411

	Page.
Image effect, transmission phenomena-----	301
Impact excitation-----	278
Impedance-----	115, 124
input, of electron tubes-----	462, 483
measurement-----	539
of telephone receivers-----	443
Imperfect dielectrics, antennas-----	814
Impulse excitation-----	278
Inclined coil instrument-----	143
Indicator, modulation-----	528
Induced electromotive force-----	108
Inductance-----	107
antenna-----	313
antenna, measurement-----	543
coils-----	109, 386, 443
coils, capacity of-----	250
coils, receiving-----	443
effective-----	416
formulas-----	386
loading-----	380, 425
measurement-----	391, 540
mutual-----	112
self-----	111
unit-----	111, 549
variable-----	427
wave length table-----	557
Induction coil-----	365
field-----	292
magnetic-----	108
motors-----	219
signaling-----	293
Inductive circuits-----	122
energy relations-----	114
Inductive coupling-----	130, 267, 541
coupling, electron tube generators-----	492
disturbances-----	578
disturbances, telephone line-----	114
reactance-----	122
Inductively-coupled receiving sets-----	423
transmitting set-----	370
Inductivity-----	92
Inductor alternator-----	165
motor-generator set-----	198
self-excited-----	202
Inductors, variable-----	444
Input circuit, electron tube-----	464
modulation-----	546
plate power, variation, modulation-----	521
resistance-----	462, 483

	Page.
Inspector, radio	562
Instruments, hot-wire	136
measuring	136
Insulated wire, tables	554
Insulating materials	34, 42
properties at radio frequencies	43
Insulators, antenna	322
Insurance, safety requirements	578
Intensity of magnetic field	104
Intensity, signal, measurement	448
Interference	289, 370
code signal	566
line radio	536
modulated continuous waves	514, 515
pure wave	377
reduction, heterodyne method	506
stations	289
transmission phenomena	289
Internal drop	56
output resistance, electron tube	482
resistance, electron tube	462
resistance of cell	63
International ampere	32, 549
call list	563
code	565
electric units	549
Morse Code	145, 565
Interruption. <i>See</i> Choppers.	
Invar	41
Ionic tubes. <i>See</i> Electron tubes.	
Ionization, arc discharge	405
by collision	453
electron tubes	452
spark discharge	356
transmission phenomena	288
Ions, arc converters	403
electrolytic conduction	61
Iron, conducting material	41
effect of, in solenoid	105
losses, transformer	133
permeability of	106
properties at radio frequencies	135
pyrites, detector	434
Jamming	370
Joule	35, 47
definition	549
Joule's law	35

	Page.
Kerosene, use in arc chamber.....	413
Key, ignition.....	416
telegraph.....	144
Keying flicker.....	580
Kick-back prevention.....	381, 496, 578
Kilovolt-amperes.....	175
Kilowatts.....	175
Kinetic energy.....	46
L, inverted, antenna.....	306, 320
Laboratory experiments.....	537
Lafayette station.....	401
Lagging current.....	121
Lalande battery.....	66
Lambda, symbol for wave length.....	282
Laminations, armature.....	158
transformer.....	129
Lamp bank rheostat.....	40
Lattice-wound inductance coll.....	445
Latour alternator.....	207
Laws, radio.....	317, 561
Lead burning.....	69
Lead-in.....	304
Leading current.....	126
Leads, telephone receiver, action.....	443
Lead storage battery.....	67, 70
sulphide detector.....	434
Leak, grid.....	476
Leakage current.....	34
flux of transformers.....	132
of condenser.....	93
Leclanche cells.....	66
Left-hand rule.....	107, 139, 154
Length, standards.....	547
wave.....	282
Lenz's law.....	109
Leyden jars. <i>See</i> Condensers.	
License, operator.....	561
station.....	561
Light, velocity of.....	283
waves.....	282, 283
Lighting lines, electric, flicker.....	580
Lightning, strays.....	290
switch.....	324, 578
Limited commercial stations.....	561
Linear law, heterodyne reception.....	505
Line drop.....	56, 58
Line of force, magnetic.....	103
radio communication.....	530

	Page.
Linkage, radiotelephony, line telephony	515
Linkages, flux	108
Lists, call	563
Liter	548
Litzendraht, high-frequency conductor	265
Load flicker	580
Loading coil	317, 380, 425, 446
inductance of	386
Local action, batteries	62
Logarithmic decrement	258
London Convention	561, 563
Long-distance telephony	150
line radio	536
Long-distance transmission, use of undamped waves	396
Long waves	396
transmission phenomena	289
Loop (<i>see also</i> Coil antenna)	304, 330
Loose-coupler	444
Loose coupling	268
Loss of energy	46
Losses, antenna	314
at radio frequency	266
dynamo	172
electron tube generator	495
transformers	132
Loud-speaking reproducer	441
Magazines, radio	568
Magnesium, spark gap terminals	357
Magnetic amplifier	399, 517
blow-out	411
circuit of dynamo	161
effects at radio frequencies	105
effect of electric current	29, 537
field	101
field, arc converter	411
field due to current	105
field, earth's	103
field intensity	104
field intensity, electromagnetic waves	287
flux	103
induction	103
instruments	138
modulator	518
permeability	105
poles	102
units	549
Magnetism	100

	Page.
Magnetizing current, transformer.....	130
Magnetos.....	162
Magnets, electro.....	101, 104
permanent.....	100
Manganese dioxide, depolarizer.....	64
Manganin.....	41
Maple, dielectric constant.....	92
Marble, dielectric constant.....	92
Mass of electron.....	451
Mass resistivity.....	36
Masts.....	322
Maximum method, direction finding.....	340
Measuring instruments.....	136
Measurement, antenna wave length.....	318
capacity.....	540
current.....	32
decrement.....	542
inductance.....	540
reactance.....	539
received current.....	448
signal intensity.....	449
voltage.....	389
wave length.....	539
Measurements, radio.....	389
Medium, wave motion.....	282
Megohm.....	35, 476
Meter.....	547
audibility.....	449
Metric systems.....	548
Mho.....	37
Mica, dielectric constant.....	92
Microfarad.....	91, 550
Microhenry.....	111, 550
Microhm.....	35
Micromicrofarad.....	550
Microphone transmitter.....	146
use in radiotelephony.....	516
Mil.....	36
Milliammeter.....	138
Millihenry.....	111, 550
Millimeter.....	548
Millivoltmeter.....	140, 143
Minimum method, direction finding.....	340
Minimum, perfect, direction finding.....	344
Modulated continuous wave, interference.....	514
Modulated waves, analysis.....	508
reception by heterodyne method.....	505
Modulating action.....	509

	Page.
Modulation, absorption method-----	516, 519
buzzer-----	529
chopper-----	529
complete-----	499, 510
definition-----	508
excessive-----	512
method-----	516, 519
power input-----	546
Modulator, magnetic-----	400, 518
Modulator tube-----	518, 522
Molybdenite detector-----	434
Moorehead tube-----	469
Morse Code-----	145
International-----	565
Motion, wave-----	281
Motor action principle-----	107
Motor-generator-----	223, 539
set-----	197
Motors-----	152, 210
compound-----	219
constant speed-----	217
induction-----	219
repulsion-----	222
series-----	218
shunt-----	210
synchronous-----	222
Mounting of crystal detector-----	434
Moving-coil type measuring instrument-----	136
Muffled rotary gap-----	363
Multilayer coil, inductance-----	388
Multiple connection of resistances-----	78
Multiple frequencies, arc converter-----	401
Multiple-tuned antenna-----	315, 398
Multiplex telegraphy-----	145
telephony-----	151, 530
Multiplier for ammeter-----	84
Multipolar machine-----	156
Multi-stage amplifiers-----	484
Mush, arc-----	402
Mushy note, heterodyne reception, modulated waves-----	505
Mutual inductance-----	112
Name plate-----	174
National Electrical Code-----	578
National Electric Safety Code-----	578
Natural frequency-----	257
Natural magnets-----	160
Navigation, application of direction finding in-----	348
Navigation, Bureau of-----	562

	Page.
Needle gap.....	390
Negative electricity.....	33
Negative resistance.....	402
New Brunswick station.....	396
New York Harbor, radio beacon system.....	349
New York Radio Central station.....	398
Nickel-iron storage cell.....	69, 71
Night, transmission phenomena.....	289
Non-conductors.....	34
Non-synchronous gap.....	368
No-voltage release.....	216
Oak, dielectric constant.....	92
Ohm, definition.....	35, 549
Ohm's law.....	34, 48, 120, 537
Oil-cooled transformers.....	134
Oils, dielectric constant.....	92
One-wave method, arc converters.....	416
Open-core transformer.....	129
Operating characteristics, electron tubes.....	464
Operator license.....	561
Operation, code signals.....	566
Ordinate.....	49
Organ pipe, continuous waves.....	285
Oscillation characteristics, electron tube.....	467
Oscillation transformer.....	371
Oscillations, arc converter.....	404
damped.....	255
forced.....	272
free.....	251
in coupled circuits.....	274
undamped.....	396
Oscillator, Hertzian.....	295
Oscillator tube.....	489, 519
Oscillon.....	472
Output resistance, electron tube.....	483
Over-compounded generator.....	188
Overmodulation.....	512
Oxidation, of spark gap terminals.....	357
Oxide coatings, electron tube filaments.....	469
Pack set.....	192, 539
Pamphlets, Signal Corps.....	575
Pancake oscillation transformer.....	371
Paper, dielectric constant.....	92
Paraffin, dielectric constant.....	92
Paragon circuit.....	427
Parallel connection, of batteries.....	60, 538
of condensers.....	99
of resistance.....	78, 538

	Page.
Parallel resonance	246
filters.....	534
Peak, double, resonance curve.....	270
Perfect condenser.....	127
Perfect minimum, direction finding.....	344
Perikon crystal detector.....	434
Period	155
Periodicals, radio.....	568
Permeability.....	105
Permanent contact crystal detector.....	436
Permanent magnet.....	101
Phantom circuit.....	150, 537
Phase, alternating current.....	120
Phase angle, alternating current	120
Phase difference.....	44, 167, 239
Phase, wave motion.....	282
Phase windings	167
Phenolic insulating materials	43
Phenolic material, dielectric constant.....	92
Phonograph record.....	507
Phosphor-bronze wire.....	325
Piano, discontinuous waves.....	285
Pick-up circuits	429
Pico (prefix).....	548
Plain antenna connection.....	369, 374, 422
Plain spark gap.....	356
Plastic substance, modulating action	510
Plate, characteristic	464
circuit resistance.....	482
current	452
modulation	521
supply, alternating-current	498
voltage.....	455, 460
Pliotron.....	472, 497
Polarization, batteries	62, 538
Poles, magnetic.....	102
Poles of battery.....	61
Polyphase alternators.....	166
Polyphase plate supply.....	500
Porcelain, dielectric constant	92
Porcelain insulators.....	322
Portable receiving set.....	337
transmitting set.....	367
Portaphone	337
Port Jefferson station.....	398
Position, code signal.....	567
Positive electricity	33
Potential difference.....	44
Potential energy	44

	Page.
Potential, gravitational.....	45
unit.....	549
Potentiometer.....	56, 84
Poulsen arc.....	405
Power.....	88
amplification coefficient.....	462
factor.....	125
factor, effect on regulation.....	177
lines, line-radio telephony on.....	535
loss, in insulating materials.....	43
losses.....	87
tubes.....	472, 497
unit.....	48, 549
Practical forms of electron tubes.....	469
Precautions, arc converter.....	404
safety.....	389, 578
Pressure contact, crystal detector.....	435
Prevention, kick-back.....	381, 496, 579
Primary, batteries.....	60, 63
circuit.....	268
of transformer.....	129
Prime mover.....	171
Propagation of waves.....	286
Public service station.....	561
Publications, Bureau of Standards.....	572
radio.....	568
Signal Corps.....	575
Pulsating current.....	25
heating effect.....	526
Pump.....	45
Puncture voltage.....	43
Pure electron flow.....	454
Pure wave.....	374, 377, 381, 396
Pyrites, iron, detector.....	434
Q. S. T.....	566
Quantity of electricity, measurement.....	33
unit.....	549
Quenched gap.....	278, 358, 542
action of, in coupled circuits.....	378
adjustment.....	378
Quenching, spark gaps.....	356
Quick tuning.....	429
Radiate.....	285
Radiation.....	292, 295
adjustment for maximum.....	382
field.....	202
resistance.....	267, 383

	Page.
Radiation, resistance of antenna.....	314
undamped waves.....	397
Radio and wire systems, linkage of.....	515
Radio beacon.....	349
circuits.....	231
Radio Communication Pamphlets, Signal Corps.....	575
Radio compass.....	340
frequency.....	191
Radio-frequency amplification, short wave.....	506
Radio-frequency amplifier.....	481
choke coils.....	525
circuits.....	231
transformers.....	135
Radiogoniometer.....	340
Radio ground system.....	327
Radio Inspection Service.....	562
Radio laws.....	561
publications.....	568
Radio Service Bulletin.....	564, 568
Radiotelephone circuits.....	522
reception.....	433
Radiotelephony.....	507
interference.....	515
Radio waves.....	287, 292
velocity of.....	283, 287
Railroads, electric, use of line radio communication.....	535
Ratio of signal to strays.....	344
Reactance.....	115
capacitive.....	126, 233
inductive.....	122
measurement.....	539
of condensers.....	126, 233
Reactance-variation method, measurement of resistance.....	394
Reaction, armature.....	177
Received current, measurement.....	448
Receiver, telephone.....	148, 421, 440
telephone, loud-speaking.....	441
Receiving apparatus.....	419
circuit, radiotelephone set.....	529
coils.....	444
condenser.....	447
sets.....	419
sets, for damped waves.....	422
sets, for undamped waves.....	430
sets, wave length calibration.....	541
Receiving station, no license required.....	562
Receiving transformer.....	444
Reception, apparatus for.....	419
autodyne.....	503

	Page.
Reception, beat-----	546
heterodyne-----	482
of radio wave-----	298
of radiotelephony-----	433
Reciprocal ohm-----	37
Rectification, see detector action.	
Rectifier, aluminum-----	497
crystal-----	487
tungar-----	544
Reference books, radio-----	571
Reflection, radio waves-----	288
Refraction, radio waves-----	288
Regenerative amplification-----	487
sensitivity-----	449
Regenerative effects in amplifiers-----	485
Regenerative receiving circuit-----	427
Regulation of generators-----	176
Regulations, radio-----	561
Regulators, voltage, d. c. generators-----	190
Re-ignition-----	405
Relay, telegraph-----	145
Relay, electron, see amplifiers, electron tube.	
Release, no-voltage-----	216
Remote control-----	398
Repeaters, electron tube, see amplifiers, electron tube.	
Repeating coil-----	515, 531
Reproducer, loud-speaking-----	441
Repulsion motor-----	222
Residual charge-----	94
Resistance-----	24, 34
antenna-----	313
antenna, measurement-----	544
box-----	38
copper wire-----	554, 556
coupling-----	267
drop-----	55
effective-----	265
effect on resonance curves-----	541
high-frequency-----	263, 542, 556
input, electron tube-----	462, 483
internal, electron tube-----	462
internal output, electron tube-----	482
measurement of-----	537
negative-----	402
radiation-----	207, 383
radio-frequency measurement-----	394
standards for radio work-----	395
telephone receivers-----	441, 443
unit-----	549

	Page.
Resistance, variable, arc.....	402
variable, speech-controlled.....	516
variation with temperature.....	37
Resistance ratio of conductors.....	263
Resistance-coupled amplifier.....	481
Resistance-variation method, measurement of resistance.....	394
Resistances in parallel.....	78
in series.....	77
Resistivity.....	35
insulating materials, temperature coefficient of.....	42
volume, of insulating materials.....	42
Resistor.....	38
Resonance.....	234, 241, 246, 375
analogs of.....	239
audio-frequency.....	382
effective decrement.....	260
parallel.....	246
parallel, filters.....	534
series.....	234
Resonance curves.....	241, 540
effective of resistance.....	541
Resonance frequency.....	235
transformer.....	134
wave coil.....	337
Resonant frequency, telephone receivers.....	441
Restricted amateur stations, licenses.....	561
Revolving-armature type dynamo.....	165
Revolving field, dynamo.....	153, 162
Rheostat.....	38
starting.....	214
Right-hand rule.....	31, 153, 537
Ring, use on arc electrode.....	413
Ring winding.....	181
Ripple, commutator.....	496, 528
Ripples, water.....	19, 281
Rope, waves on.....	281
Rotary converter.....	224
Rotary gaps.....	361
synchronous.....	361
non-synchronous.....	363
Rotary quenched gap.....	364
Rotary gap, safety precautions.....	580
Rotating plate condenser.....	431
Rotor.....	162
Rubber, hard, dielectric constant.....	92
Safety precautions.....	389, 578
Sal ammoniac.....	64
Salt water, to be avoided in arc converter.....	412

	Page.
Saturation, electron tube.....	459
Screen, use as counterpoise.....	327
Seasonal variations of radio signals.....	290
Second, unit of time.....	548
Secondary batteries.....	60, 67
Secondary circuit.....	268
Secrecy, line radio.....	532
Segments, commutator.....	181
Selective circuit.....	422
tuning.....	379
Selectivity, filters.....	534
Self-inductance (<i>see also</i> Inductance).....	111
Sense of direction.....	341
Sensitive spots, crystal detectors.....	435
Sensitivity of receiving apparatus.....	449
Separate excitation.....	184
d. c. generators.....	184
Separate heterodyne.....	503
Separator, storage cell.....	69
Series condenser, antenna.....	380
Series connection.....	538
batteries.....	60
condensers.....	99
Series excitation.....	186
d. c. generators.....	186
Series motor.....	218
Series resonance.....	234
Shape factor.....	387
Sharpness of minimum, direction finder.....	343
Sharp tuning.....	396, 425
Sharp tuning, continuous waves.....	514
Sharp wave.....	38, 260, 374, 377
Shellac base insulating materials.....	92, 323
Shellac, dielectric constant.....	92
Shipping Board, U. S.....	401
Ships, use of direction finder on.....	348
Short-circuits, dynamos.....	228
transformers.....	131
Short-wave amplification.....	485, 506
antenna.....	318
heterodyne reception.....	504
radio-frequency amplification.....	506
receiving set.....	425
Shunt circuits.....	82
Shunt excitation.....	184
Shunt excitation, d. c. generators.....	184
Shunt for ammeter.....	141
Shunt motors.....	211
Shunted telephone method, signal intensity measurement.....	448

	Page.
Side frequencies	531
Side waves	509
interference	515
Signal Corps pamphlets	575
Signal Corps radiotelephone sets	527
Signal intensity, measurement	449
Signaling, induction	293
Signaling methods, arc converter	415
Signals, conventional	565
Signals, swinging of	291
Silicon-bronze wire	326
Silicon-carbide detector	434
Silicon detector	434
Silicon steel, transformers	133
Silk, dielectric constant	92
Silver-chloride cell	64
Simple voltaic cell	61
Sine wave	116, 155
Single-layer coil	386
Single-phase alternator	167
Skin effect	263, 542, 556
Slate, properties at radio frequencies	43
Slip rings	162
Soft tubes	454
Solenoid	104, 386
Solenoid, rule for direction of magnetic field in	106
Solid-back transmitter	146
Sound, resonance in	262
Sounder	144
Sound waves	281, 283, 507, 512
Source, decrement of	542
wavemeter	540
Sources of electromotive force	51
Space charge effect	456
Spacing wave	416
Spark discharge	405
Spark frequency	355
Spark gap	354
quenched	278, 358
rotary	361
Spark, timed	364
Sparking, dynamos	229
Sparking distance	390
Sparking voltage	390
Special amateur stations, license	561
Specific inductive capacity	92
Specific resistance	36
Speech, wave forms	507
Speech-controlled variable resistance	516
Speed regulation, motors	217

	Page.
Sphere, capacity-----	96
Sphere gap-----	390
Spider-web inductance coil-----	445
Spiral, inductance of-----	388
Spiral oscillation transformer-----	371
Spiral type coil antenna-----	334
Split-phase starting-----	221
Spreaders, antenna-----	306, 322
Spring, vibration of-----	256
Square law, contact detector-----	440
electron tube detector-----	473, 505
Squier, General G. O-----	583
Squirrel-cage induction motor-----	221
Stabilizer, amplifier-----	486
Stagger-wound inductance coil-----	445
Standard cell-----	56
Standards-----	547
Standards, Bureau of-----	547, 572
Standards, resistance-----	395
Stand-by circuits-----	429
Stand-by, code signal-----	566
Star connection-----	169
Starting-box-----	213
Starting rheostat-----	214
Static-----	290
Static electricity-----	52
Station call letters-----	563
Station design, safety precautions-----	578
Station license-----	561
Stator-----	162
Steel, contact detector-----	434
Steel conductor-----	40
Steel wire gauge-----	41
Step-up transformer-----	128
Storage battery, charging-----	538
Storage cells-----	60, 67
Strain insulator-----	323
Strain of dielectric-----	90
Stranded wire-----	325
Strays-----	290
reduction by coil antennas-----	344
reduction, heterodyne method-----	505
Striker, arc converter-----	416
Strong signals, code signal-----	566
Structural dimensions of electron tube, calculation of constants from-----	483
Submarine antenna-----	338
Submerged antenna-----	328, 338
Sulphation, lead storage batteries-----	74

	Page.
Sulphide, iron, detector	434
Sulphide, lead, detector	434
Sulphur, dielectric constant	92
Summer, strays	290
Sunrise, distortion of radio waves	348
Super-heterodyne	506
Suppression of carrier wave	514
Surface leakage	34
insulating materials	42
Surges, radio-frequency, prevention	578
Swing, damping, analogy	262
Swinging, transmission phenomena	291
Switch, antenna	324
lightning	578
wave change	380
Symbols for physical quantities	552
Symmetry of resonance curves	243
Synchronous converter	224
Synchronous gap	361
Synchronous motors	222
System, metric	548
T type antenna	306
Tables, copper wire	554
wave length	557
Tank circuit, arcs	417
Tapering charge method, storage cells	73
Technical school station, license	561
Telefunken alternator	210
tube	472
Telegraphy, multiplex	530
wire	144
Telephone receiver	148, 421, 440
impedance	443
Telephony, carrier-frequency	530
line radio	530
linkage of radio and line	515
multiplex	530
radio	507
radio, reception	433
wire	145
Temperature, filament	456
Temperature coefficient of resistance	37
Terminals, spark gap	357
Terminal voltage, dynamo	186
Tesla coil	134
Text-books, radio	570
Thermal ammeters	136
Thermo-couple ammeter	136

	Page.
Thermoelectricity.....	54
Thermoelement.....	55
Three-electrode tube.....	456
Three-phase plate supply.....	500
Thumb rule.....	81
Tikker.....	431
Tilting of wave front.....	328
Time constant.....	91
Timed spark.....	364
Tinfoil, use as fuse.....	496
Tone modulation.....	508
Torque.....	219
Towers.....	322
Tractor, radio.....	194
Traffic, code signals.....	566
Trailing wire antenna, aircraft.....	311
Train frequency.....	439
Training Pamphlets, Signal Corps.....	576
Trains, wave.....	285
Transformer.....	128
Transformer, a. c., filament supply.....	496
amplifier.....	481
bell-ringing.....	134
effective inductance.....	137
high-frequency.....	272
oscillation.....	371
radio-frequency.....	135, 482
receiving.....	444
resonance.....	134
supply line, separate.....	580
Transformer action.....	293
Transformer-coupled amplifier.....	480
Transformer oil, dielectric constant.....	92
Transmission, directive.....	321
power by alternating current.....	128
radio waves.....	288
Transmission formulas.....	299
Transmitter, condenser.....	518
microphone.....	146
Transmitting circuits.....	368
Transmitting condensers.....	356
Transmitting sets, adjustment.....	376
arc.....	400
direct-coupled.....	373
inductively-coupled.....	370
portable.....	367
Transmitting station, license.....	561
Transposition, telephone lines.....	113, 536
Transverse magnetic field, arc converter.....	411

	Page.
Triangulation, radio-----	321, 349
Triodes, see electron tubes.	
Tropical radio-----	290
Trouble in operating dynamos-----	227
Trough of wave-----	282
Tube, electron-----	450
electron, construction-----	457
modulator-----	518, 522
transmitters-----	498
transmitting sets-----	400
Tubing, high-frequency resistance of-----	265
Tuned circuit-----	235
line radio-----	532
Tuned telephone receivers-----	441
Tungar rectifier-----	544
Tuning-----	240
audio-frequency-----	382
effective decrement on-----	260
Tuning fork-----	262
sine wave-----	507
Tuning of transmitting sets-----	376
Tuning, sharp-----	396
Tungsten filaments, electron tubes-----	469
Two-electrode electron tube-----	428, 451
Two-phase a. c. plate supply-----	500
Two-phase alternator-----	167
Two-way communication-----	532
Two-way radiotelephony-----	527
Umbrella type antenna-----	303
Undamped oscillations-----	257
Undamped waves-----	396
circuits for reception of-----	430
Underground antennas-----	328
Underwater antenna-----	329
Underwriters, fire-----	578
Unidirectional direction finder-----	345
Unilateral conductivity, contact detector-----	437
Unipolar connection for wavemeter-----	392
United States call letters-----	563
United States radio laws-----	317, 561
United States Signal Corps-----	527, 575
Units-----	547
abbreviations-----	549
Uniwave methods, arc converter-----	416
Unsymmetrical directional characteristic-----	345
V-type antenna-----	306
Vacuum tubes, see electron tubes.	
Valves, see electron tubes.	

INDEX.

617

	Page.
Variable antenna reactance method, modulation-----	518
Variable condenser-----	447
Variable inductor-----	427, 445
Variable resistance, electron tube as-----	462
modulator tube-----	522
of arc-----	402
Variations of radio signals-----	291, 347
Variation power, modulation-----	521
Variation, wave length, modulation-----	518
Variometer-----	427, 445
Velocity of electromagnetic waves-----	283, 287
of light waves-----	283, 287
of water waves-----	282, 283
of wave-----	282
Vernier condenser-----	448
Vertical wire antenna-----	320
Vibrating reed telephone receiver-----	441
Visual signaling-----	20
Voice-controlled variable resistance-----	146
Voice modulation-----	508, 512
Volt, definition-----	549
Voltage amplification, electron tube-----	484
Voltage control, of generator-----	179
Voltage divider-----	56
electron tube amplifier-----	487
Voltage drop in battery or generator-----	57
Voltage, measurement-----	389
measurement by spark gap-----	390
Voltage of primary cells-----	66
Voltage, puncture-----	43
Voltage regulators, d. c. generators-----	190
Voltage relations, a. c. circuits-----	123
Voltage, sparking-----	389
Voltage terminal, dynamo-----	186
Voltage, unit-----	549
Voltaic cell-----	54
Volt, definition-----	47
Voltmeter-----	47, 141
Volume resistivity-----	42
Volume, units-----	548
Vulcanized fiber, dielectric constant-----	92
Washington Monument-----	347
Watchcase telephone receiver-----	148, 441
Water, dielectric constant-----	92
Watermotive force-----	46
Water-pipe ground-----	327
Water rheostat-----	39
Water waves, velocity of-----	282, 283
Water wire-----	329

	Page.
Watt.....	48
definition.....	549
Wave, amplitude of.....	284
Wave, carrier.....	508
Wave forms, radiotelephony.....	507
Wave front angle.....	328
Wave front, distortion of.....	347
Wave front, tilting of.....	328
Wave length.....	282
antenna.....	318
changes.....	370
coil antenna.....	335
definition.....	282
fundamental, measurement.....	543
measurement.....	316, 391
natural.....	557
table.....	557
variation method, modulation.....	518
Wave motion.....	281
Wave, radiation.....	297
Wave, sine.....	116
Wave train.....	260, 285
Wavemeter.....	244, 391, 539
unipolar connection.....	392
use for adjusting transmitting set.....	381
Waves, continuous.....	285, 396
continuous, from electron tube generators.....	495
Waves, damped.....	255, 353
electromagnetic.....	283, 287
heat.....	283
light.....	282, 283
on water.....	19
propagation of.....	286
radio.....	292
side.....	509
sound.....	281, 283, 507, 512
undamped.....	254, 396
Wax, beeswax, dielectric constant.....	92
Weight of copper wire.....	555
Weight of electron.....	451
Weight, standards.....	547
units.....	548
Well, use as ground.....	327
Western Electric tube.....	469
Weston standard cell.....	56
Wheatstone bridge.....	86, 538
Windage.....	172
Windings, armature.....	159
concentrated.....	159

INDEX.

619

	Page.
Windings, distributed-----	159
drum-----	181
polyphase alternators-----	168
ring-----	181
Winter, strays-----	290
Wire and radio systems, linkage of-----	515
Wire, antenna-----	324
copper, tables-----	554
gauge-----	41, 554
ground-----	327
telegraphy-----	144
telephony-----	145
underwater-----	328
Wire Communication Pamphlets, Signal Corps-----	576
Wire-radio telephony-----	530
Wired radio-----	530
Wired wireless-----	530
Wireless, see radio.	
Wiring, safety precautions-----	578
Wood, dielectric constant-----	92
Wood-screw rule-----	31
Wood's metal-----	434
Work-----	44
Work, unit-----	549
Working wave-----	415
X's-----	290
Y connection-----	169
Yard, unit of length-----	548
Yellow light waves-----	283
Yoke, dynamo-----	165
Zero beat reception-----	514
Zinc oxide, detector-----	434
Zinc spark gap terminals-----	357
Zincite detector-----	434

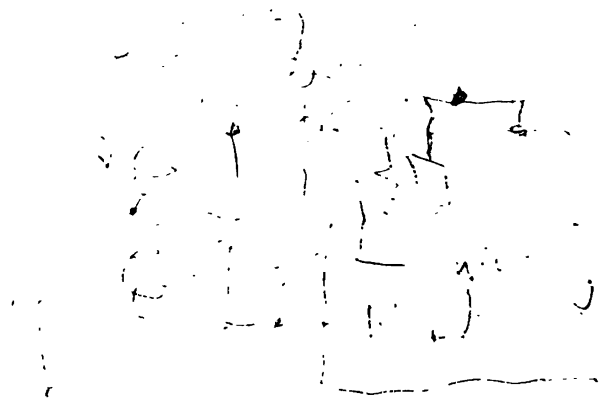

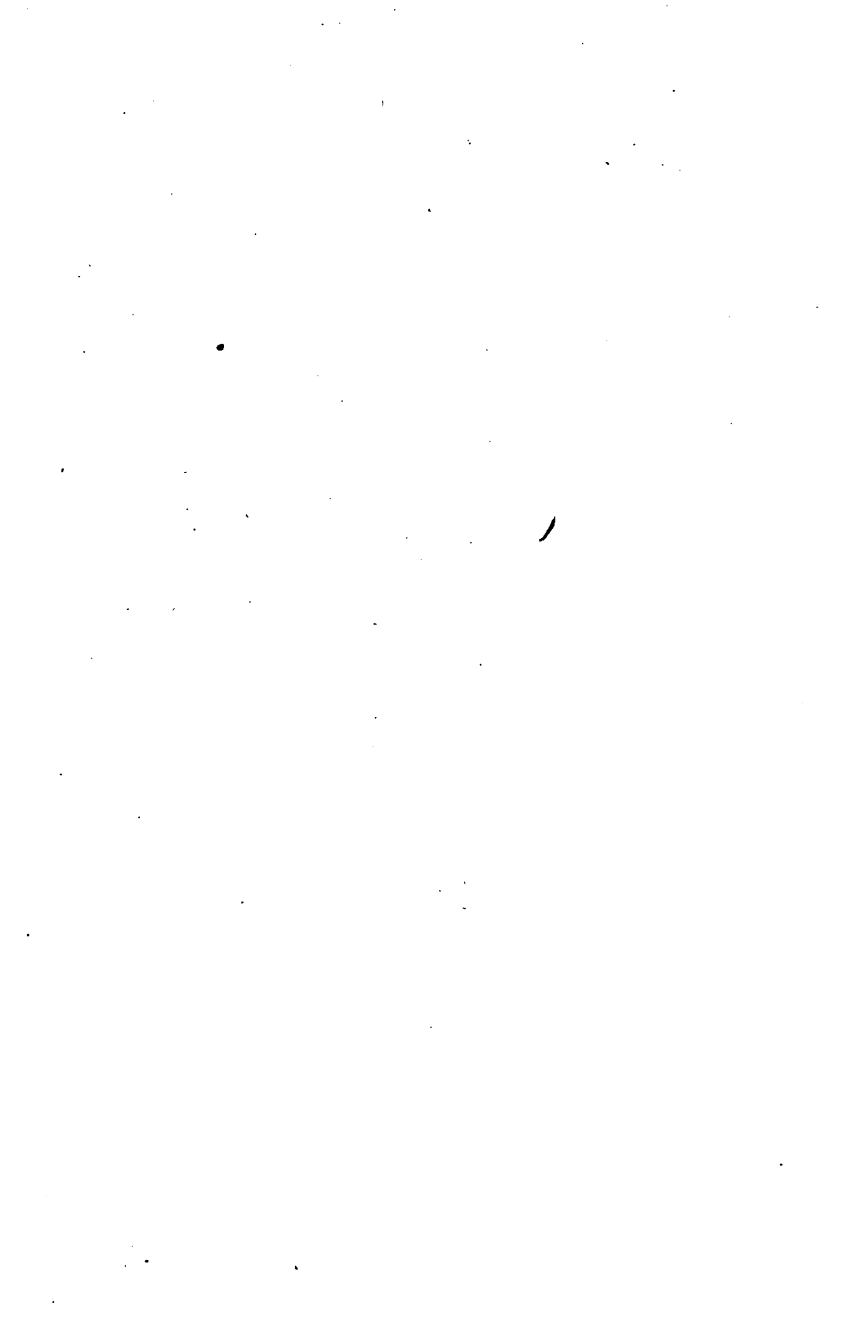

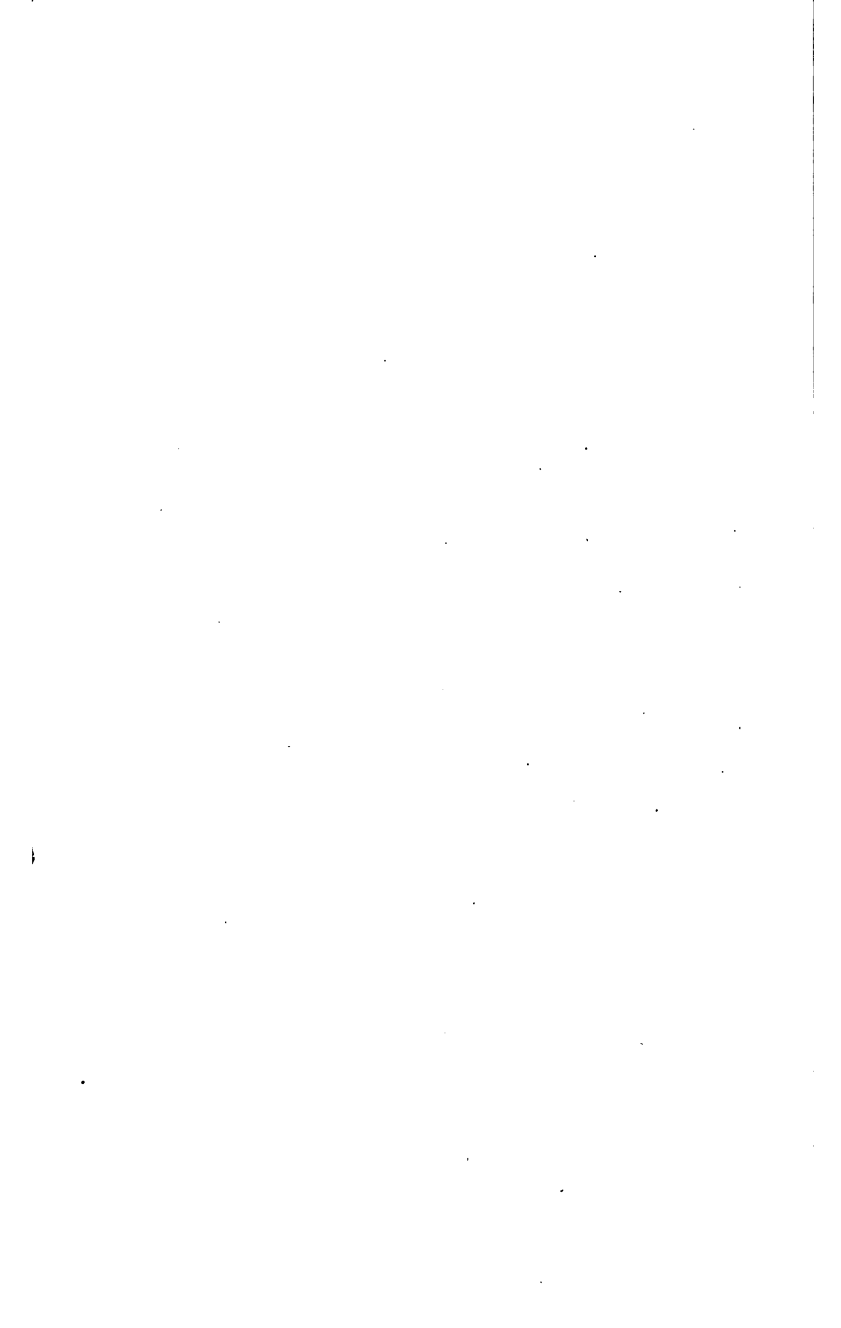

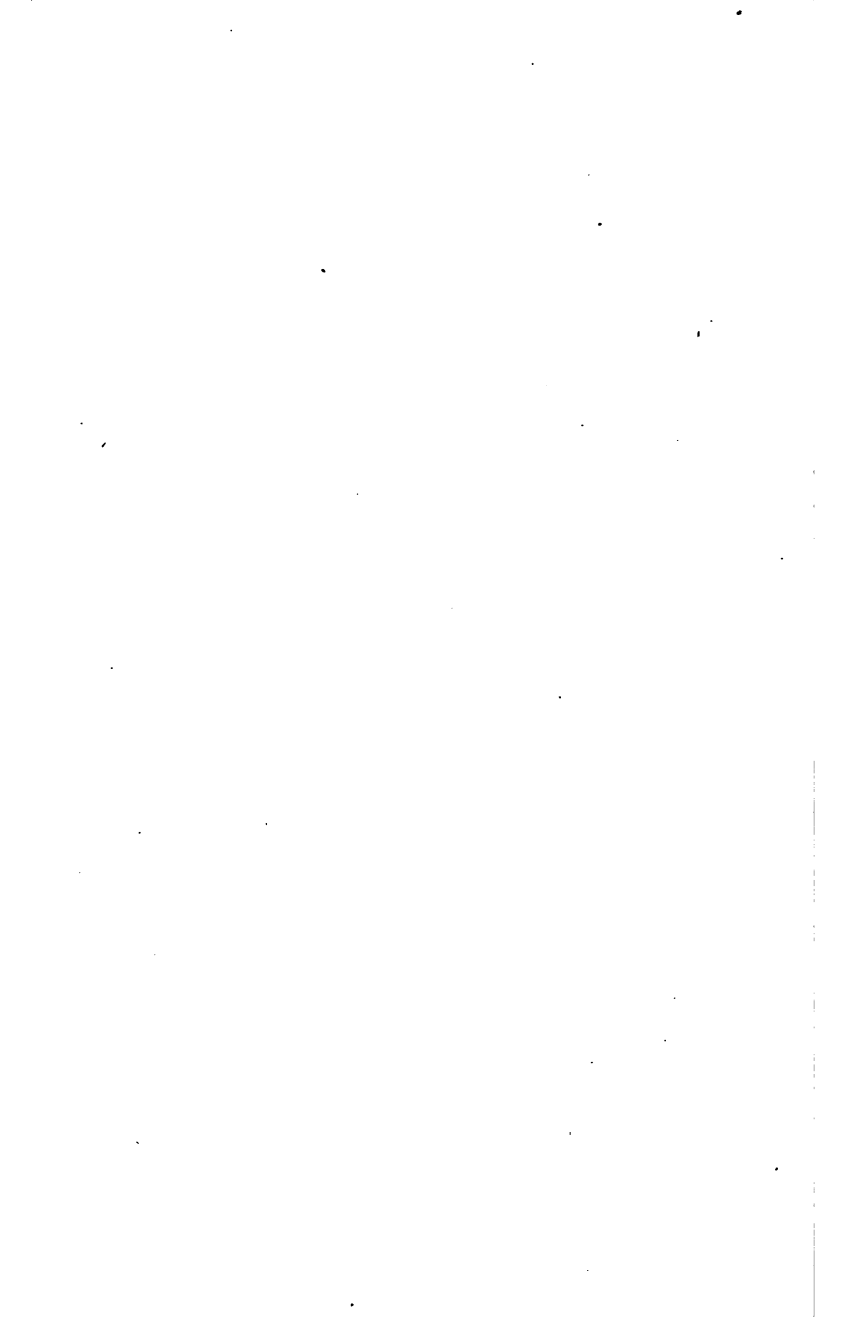



48

1957 11 10

YE

477548

UNIVERSITY OF CALIFORNIA LIBRARY



